

Metropolitan Supply

Automotive Hardware



7580 Quattro Drive, Chanhassen, MN 55317
1-800-844-3008 Toll Free | 1-888-244-7329 Toll Free Fax
www.MetropolitanSupply.com

Table of Contents

Conversion Table	3
Section 1	
Screws	4
Section 2	
Standard & Metric Fasteners	25
Section 3	
Special Nuts	41
Section 4	
Shield Retainers	73
Section 5	
Windshield Fasteners	125
Section 6	
Door Fasteners	129
Section 7	
Headlight Fasteners	173
Section 8	
Miscellaneous	178
Section 9	
Rivets	201
Section 10	
Electrical Products	215
Section 11	
Tools	228
Section 12	
Assortments	231

Inch - Metric Conversion Table

Inches			Inches			Inches			Inches		
Fraction	Decimal	MM	Fraction	Decimal	MM	Fraction	Decimal	MM	Fraction	Decimal	MM
—	.0004	.01	11/32	.34375	8.731	—	.7480	19	1-11/32	1.344	34.131
—	.004	.10	—	.3543	9	3/4	.7500	19.050	1-3/8	1.375	34.925
—	.01	.25	23/64	.35937	9.128	49/64	.7656	19.447	—	1.3779	35
1/64	.0156	.397	—	.374	9.5	25/32	.78125	19.844	1-13/32	1.406	35.719
—	.0197	.50	3/8	.3750	9.525	—	.7874	20	—	1.4173	36
—	.0295	.75	25/64	.3906	9.922	51/64	.79687	20.241	1-7/16	1.438	36.513
1/32	.03125	.794	—	.3937	10	13/16	.8125	20.638	—	1.4567	37
—	.0394	1	13/32	.4062	10.319	—	.8268	21	1-15/32	1.469	37.306
3/64	.0469	1.191	—	.413	10.5	53/64	.8281	21.034	—	1.4961	38
—	.059	1.5	27/64	.42187	10.716	27/32	.84375	21.431	1-1/2	1.500	38.100
1/16	.0625	1.588	—	.4331	11	55/64	.85937	21.828	1-17/32	1.531	38.894
5/64	.0781	1.984	7/16	.4375	11.113	—	.8662	22	—	1.5354	39
—	.0787	2	29/64	.4531	11.509	7/8	.8750	22.225	1-9/16	1.562	39.688
3/32	.094	2.381	15/32	.46875	11.906	57/64	.8906	22.622	—	1.5748	40
—	.0984	2.5	—	.4724	12	—	.9055	23	1-19/32	1.594	40.481
7/64	.1093	2.776	31/64	.48437	12.303	29/32	.90625	23.019	—	1.6142	41
—	.1181	3	—	.492	12.5	59/64	.92187	23.416	1-5/8	1.625	41.275
1/8	.1250	3.175	1/2	.500	12.700	15/16	.9375	23.813	—	1.6535	42
—	.1378	3.5	—	.5118	13	—	.9449	24	1-21/32	1.6562	42.069
9/64	.1406	3.572	33/64	.5156	13.097	61/64	.9531	24.209	1-11/16	1.6875	42.863
5/32	.15625	3.969	17/32	.53125	13.494	31/32	.96875	24.606	—	1.6929	43
—	.1575	4	35/64	.54687	13.891	—	.9843	25	1-21/32	1.719	43.656
11/64	.17187	4.366	—	.5512	14	1	1.000	25.4	—	1.7323	44
—	.177	4.5	9/16	.5625	14.288	—	1.0236	26	1-3/4	1.750	44.450
3/16	.1875	4.763	—	.571	14.5	1-1/32	1.0312	26.194	—	1.7717	45
—	.1969	5	37/64	.57812	14.684	1-1/16	1.062	26.988	1-25/32	1.781	45.244
13/64	.2031	5.159	—	.5906	15	—	1.063	27	—	1.8110	46
—	.2165	5.5	19/32	.59375	15.081	1-3/32	1.094	27.781	1-13/16	1.8125	46.038
7/32	.2187	5.556	39/64	.60937	15.478	—	1.1024	28	1-27/32	1.844	46.831
15/64	.23437	5.953	5/8	.6250	15.875	1-1/8	1.125	28.575	—	1.8504	47
—	.2362	6	—	.6299	16	—	1.1417	29	1-7/8	1.875	47.625
1/4	.2500	6.350	41/64	.6406	16.272	1-5/32	1.156	29.369	—	1.8898	48
—	.2559	6.5	—	.6496	16.5	—	1.1811	30	1-29/32	1.9062	48.419
17/64	.2656	6.747	21/32	.65625	16.669	1-3/16	1.1875	30.163	—	1.9291	49
—	.2756	7	—	.6693	17	1-7/32	1.219	30.956	1-15/16	1.9375	49.213
9/32	.28125	7.144	43/64	.67187	17.066	—	1.2205	31	—	1.9685	50
—	.2953	7.5	11/16	.6875	17.463	1-1/4	1.250	31.750	1-31/32	1.969	50.006
19/64	.29687	7.541	45/64	.7031	17.859	—	1.2598	32	2	2.000	50.800
5/16	.3125	7.938	—	.7087	18	1-9/32	1.281	32.544	—	2.0079	51
—	.3150	8	23/32	.71875	18.256	—	1.2992	33			
21/64	.3281	8.334	—	.7283	18.5	1-5/16	1.312	33.338			
—	.335	8.5	47/64	.73437	18.653	—	1.3386	34			



Screws

Metropolitan Supply

9870PK



4-24- x 3/8"
Phillips Flat Head
Moulding Screw Studs

100 Pcs.

1810PK



(Bright Zinc Finish)

8 x 3/8" 6 Head
3/8" O.D. Washer
Phillips Oval Washer Head
Wheel Opening Moulding Screws

100 Pcs.

552PK



(Bright Zinc Finish)

8-18 x 7/16"
Phillips Washer Head
9/32" O.D. Head Diameter
Wheel Moulding Screws

100 Pcs.

9244PK



(Bright Zinc Finish)

8 x 7/16"
3/8" Washer Diameter
Phillips Washer Head
Trim Screws

100 Pcs.

9161PK



(Chrome Finish)

4.2-1.41 x 12mm
10mm O.D. Washer
Phillips Pozi-Driv Washer Head
Trim Screws

100 Pcs.

9856PK



(Chrome Finish)

8 x 5/8"
Phillips Round Washer Head
13/32" Washer O.D.
Trim Screws

100 Pcs.

Metropolitan Supply



Phillips Oval Head Bright Zinc Finish Sheet Metal Screws

Part Number	Size	Head Size	Pkg Qty
533PK	6 x 1/2"	# 6	100
534PK	6 x 3/4"	# 6	100
535PK	6 x 1"	# 6	100
10145PK	6 x 1 1/4"	# 6	100
539PK	8 x 1/2"	# 8	100
542PK	8 x 3/4"	# 8	100
545PK	8 x 1"	# 8	100
10146PK	8 x 1 1/4"	# 8	100
10147PK	8 x 1 1/2"	# 8	100
10148PK	8 x 1 3/4"	# 8	100
10149PK	8 x 2"	# 8	100
10150PK	10 x 1/2"	#10	100
555PK	10 x 3/4"	#10	100
557PK	10 x 1"	#10	100
558PK	10 x 1 1/4"	#10	100
559PK	10 x 1 1/2"	#10	100
560PK	10 x 1 3/4"	#10	100
561PK	10 x 2"	#10	100
10151PK	12 x 1/2"	#12	100
10152PK	12 x 3/4"	#12	100
10153PK	12 x 1"	#12	100
10154PK	12 x 1 1/4"	#12	100
10155PK	12 x 1 1/2"	#12	100
10156PK	12 x 2"	#12	100



Phillips Oval Head Chrome Finish Sheet Metal Screws (Undersized Head)

Part Number	Size	Head Size	Pkg Qty
6399PK	8 x 3/8"	# 6	100
6400PK	8 x 1/2"	# 6	100
6401PK	8 x 3/4"	# 6	100
6402PK	8 x 1"	# 6	100
6403PK	8 x 1 1/4"	# 6	100
6404PK	8 x 1 1/2"	# 6	100
10163PK	8 x 1 3/4"	# 6	100
10164PK	10 x 1/2"	# 6	100
6405PK	10 x 3/4"	# 6	100
6406PK	10 x 1"	# 6	100
6407PK	10 x 1 1/4"	# 6	100
6408PK	10 x 1 1/2"	# 6	100
10165PK	10 x 1 3/4"	# 6	100
6409PK	10 x 1/2"	# 8	100
6410PK	10 x 3/4"	# 8	100
6411PK	10 x 1"	# 8	100
6412PK	10 x 1 1/4"	# 8	100



Phillips Oval Head Black Finish Sheet Metal Screws (Undersized Head)

Part Number	Size	Head Size	Pkg Qty
9479PK	8 x 1/2"	# 6	100
1184PK	8 x 3/4"	# 6	100
1186PK	8 x 1"	# 6	100
9211PK	8 x 1 1/4"	# 6	100
1188PK	8 x 1 1/2"	# 6	100
10166PK	10 x 1/2"	# 8	100
9480PK	10 x 3/4"	# 8	100
9252PK	10 x 1"	# 8	100
10167PK	10 x 1 1/4"	# 8	100
10168PK	10 x 1 1/2"	# 8	100



Phillips Oval Head Chrome Finish Sheet Metal Screws

Part Number	Size	Head Size	Pkg Qty
6293PK	6 x 1/2"	# 6	100
6294PK	6 x 3/4"	# 6	100
6295PK	6 x 1"	# 6	100
6296PK	6 x 1 1/4"	# 6	100
6299PK	8 x 3/8"	# 8	100
6300PK	8 x 1/2"	# 8	100
6301PK	8 x 3/4"	# 8	100
6302PK	8 x 1"	# 8	100
6303PK	8 x 1 1/4"	# 8	100
6304PK	8 x 1 1/2"	# 8	100
6307PK	10 x 1/2"	#10	100
6308PK	10 x 3/4"	#10	100
6309PK	10 x 1"	#10	100
6310PK	10 x 1 1/4"	#10	100
6311PK	10 x 1 1/2"	#10	100

Metropolitan Supply



Phillips Oval Head Black Finish Sheet Metal Screws

Part Number	Size	Head Size	Pkg Qty
10169PK	6 x 1/2"	# 6	100
10170PK	6 x 3/4"	# 6	100
10171PK	6 x 1"	# 6	100
10172PK	6 x 1 1/4"	# 6	100
1468PK	8 x 1/2"	# 8	100
1183PK	8 x 3/4"	# 8	100
1185PK	8 x 1"	# 8	100
10173PK	8 x 1 1/4"	# 8	100
1187PK	8 x 1 1/2"	# 8	100
10174PK	10 x 1/2"	#10	100
1469PK	10 x 3/4"	#10	100
1470PK	10 x 1"	#10	100
10175PK	10 x 1 1/4"	#10	100
10176PK	10 x 1 1/2"	#10	100



Phillips Pan Head Bright Zinc Finish Sheet Metal Screws

Part Number	Size	Pkg Qty
10157PK	6 x 1/2"	100
485PK	6 x 3/4"	100
486PK	6 x 1"	100
487PK	6 x 1 1/4"	100
489PK	8 x 1/2"	100
492PK	8 x 3/4"	100
493PK	8 x 1"	100
10052PK	8 x 1 1/4"	100
494PK	8 x 1 1/2"	100
495PK	10 x 1/2"	100
496PK	10 x 3/4"	100
497PK	10 x 1"	100
10158PK	10 x 1 1/4"	100
498PK	10 x 1 1/2"	100
499PK	12 x 1/2"	100
500PK	12 x 3/4"	100
501PK	12 x 1"	100
10159PK	12 x 1 1/4"	100
10160PK	12 x 1 1/2"	100
502PK	14 x 1/2"	100
503PK	14 x 3/4"	100
504PK	14 x 1"	100
10161PK	14 x 1 1/4"	100
10162PK	14 x 1 1/2"	100
505PK	14 x 1 3/4"	100
506PK	14 x 2"	100
9213PK	14 x 2 1/2"	50



Phillips Pan Head Black Finish Sheet Metal Screws

Part Number	Size	Pkg Qty
10101PK	6 x 1/2"	100
10102PK	6 x 3/4"	100
10103PK	6 x 1"	100
10104PK	6 x 1 1/4"	100
1623PK	8 x 1/2"	100
1624PK	8 x 3/4"	100
1625PK	8 x 1"	100
10105PK	8 x 1 1/4"	100
1626PK	8 x 1 1/2"	50
1722PK	10 x 1/2"	100
1723PK	10 x 3/4"	100
1724PK	10 x 1"	50
1725PK	10 x 1 1/4"	50
1726PK	10 x 1 1/2"	50



Phillips Pan Head Bright Zinc Finish Teks® Screws

Part Number	Size	Pkg Qty
1964PK	8 x 1/2"	100
1965PK	8 x 3/4"	100
1966PK	8 x 1"	100
1967PK	10 x 1/2"	100
1968PK	10 x 3/4"	100
1969PK	10 x 1"	100

Metropolitan Supply



Indented Hex Head Bright Zinc Finish Tek® Screws

Part Number	Size	Hex Size	Pkg Qty
1077PK	8 x 1/2"	1/4"	100
1078PK	8 x 3/4"	1/4"	100
9791PK	8 x 1"	1/4"	100
9792PK	8 x 1 1/4"	1/4"	50
9353PK	8 x 1 1/2"	1/4"	50
9841PK	10 x 1/2"	5/16"	100
1079PK	10 x 5/8"	5/16"	100
9346PK	10 x 3/4"	5/16"	100
1080PK	10 x 1"	5/16"	100
9793PK	10 x 1 1/4"	5/16"	50
9794PK	10 x 1 1/2"	5/16"	50
9843PK	12 x 3/4"	5/16"	100
9795PK	12 x 1"	5/16"	25
9796PK	12 x 1 1/4"	5/16"	25
1970PK	14 x 3/4"	3/8"	100
1971PK	14 x 1"	3/8"	25
9797PK	14 x 1 1/4"	3/8"	25
9842PK	14 x 1 1/2"	3/8"	25



Slotted Indented Hex Washer Head Bright Zinc Finish Sheet Metal Screws

Part Number	Size	Head Size	Pkg Qty
10177PK	6 x 1/2"	1/4"	100
10178PK	6 x 3/4"	1/4"	100
10179PK	8 x 1/2"	1/4"	100
10180PK	8 x 3/4"	1/4"	100
10181PK	8 x 1"	1/4"	100
10182PK	8 x 1 1/4"	1/4"	100
10183PK	10 x 1/2"	5/16"	100
10184PK	10 x 3/4"	5/16"	100
10185PK	10 x 1"	5/16"	100
10186PK	10 x 1 1/4"	5/16"	100
10187PK	10 x 1 1/2"	5/16"	100
10188PK	12 x 1/2"	5/16"	100
10189PK	12 x 3/4"	5/16"	100
10190PK	12 x 1"	5/16"	100
10191PK	12 x 1 1/4"	5/16"	100
10192PK	12 x 1 1/2"	5/16"	100
1620PK	14 x 3/4"	3/8"	50
10193PK	14 x 1"	3/8"	50
10194PK	14 x 1 1/4"	3/8"	50

9227PK



(Bright Zinc Finish)

8 x 1/2"
1/4" Hex Head Slotted
Indented Hex Washer Head
Pierce Point Sheet Metal Screws

100 Pcs.



Phillips Oval Head Loose Washer Chrome Finish Sems® Countersunk Trim Screws

(Washer Design Will Not Cut Into Pads)

Part Number	Size	Head Size	Pkg Qty
5760PK	8 x 3/4"	# 6	100
5761PK	8 x 1"	# 6	100
9197PK	8 x 1 1/4"	# 6	100
5762PK	10 x 3/4"	# 8	100
5763PK	10 x 1"	# 8	100

Metropolitan Supply



**Phillips Oval Head
Loose Washer
Black Finish
Sems® Countersunk
Trim Screws**

(Washer Design Will Not Cut Into Pads)

Part Number	Size	Head Size	Pkg Qty
9865PK	8 x 5/8"	# 6	100
1640PK	8 x 3/4"	# 6	100
1641PK	8 x 1"	# 6	100
9489PK	10 x 3/4"	# 8	50
9490PK	10 x 1"	# 8	50

9160PK



(Black Finish)

**8 x 3/4"
13/32" O.D. Washer Head
Phillips Oval Washer Head
Trim Screws**

100 Pcs.



**Phillips Oval Head
Loose Washer
Black Finish
Sems® Countersunk
Teks® Trim Screws**

(Washer Design Will Not Cut Into Pads)

Part Number	Size	Head Size	Pkg Qty
1303PK	8 x 3/4"	# 6	100
1642PK	8 x 1"	# 6	50
10757PK	8 x 1 1/4"	# 6	50

5765PK



(Bright Zinc Finish)

**8 x 1/2"
7/16" O.D. Washer Head
Phillips Oval Washer Head
Wheel Opening Mldg. Teks® Screws**

50 Pcs.

9268PK



**8 Screw Size
Countersunk Type
Nickel Plated Steel
Finish Washer**

100 Pcs.

6185PK



(Chrome Finish)

**8 x 1/2"
7/16" O.D. Washer Head
Phillips Oval Washer Head
Wheel Opening Mldg. Teks® Screws**

50 Pcs.

Metropolitan Supply

6010PK



(Black Finish)

8 x 1/2"
7/16" O.D. Washer Head
Phillips Oval Washer Head
Wheel Opening Mldg. Teks® Screws

50 Pcs.

6265PK



(Black Finish)

8 x 3/4"
7/16" O.D. Washer Head
Phillips Oval Washer Head
Mounting Teks® Screws

50 Pcs.

6267PK



(Black Finish)

8 x 1"
7/16" O.D. Washer Head
Phillips Oval Washer Head
Mounting Teks® Screws

50 Pcs.

5790PK



(Bright Zinc Finish)

8 x 1/2"
13/32" O.D. Washer Head
Phillips Flat Top Washer Head
Trim Screws

100 Pcs.

1795PK



(Bright Zinc Finish)

8 x 3/4"
13/32" O.D. Washer Head
Phillips Flat Top Washer Head
Trim Screws

100 Pcs.

1796PK



(Bright Zinc Finish)

8 x 1"
13/32" O.D. Washer Head
Phillips Flat Top Washer Head
Trim Screws

100 Pcs.

Metropolitan Supply

5791PK



(Black Finish)

8 x 1/2"
13/32" O.D. Washer Head
Phillips Flat Top Washer Head
Trim Screws

100 Pcs.

5792PK



(Black Finish)

8 x 5/8"
13/32" O.D. Washer Head
Phillips Flat Top Washer Head
Trim Screws

100 Pcs.

5984PK



(Black Finish)

8 x 3/4"
13/32" O.D. Washer Head
Phillips Flat Top Washer Head
Trim Screws

100 Pcs.

5989PK



(Black Finish)

8 x 1"
13/32" O.D. Washer Head
Phillips Flat Top Washer Head
Trim Screws

100 Pcs.

5990PK



(Black Finish)

8 x 1 1/4"
13/32" O.D. Washer Head
Phillips Flat Top Washer Head
Trim Screws

50 Pcs.

10632PK



(Black Finish)

8 x 1 1/2"
13/32" O.D. Washer Head
Phillips Flat Top Washer Head
Trim Screws

50 Pcs.

Metropolitan Supply

10723PK

NEW!



(Black Finish)

10 x 1/2"
15/32" O.D. Washer Head
Phillips Flat Top Washer Head
Trim Screws

100 Pcs.

9497PK

NEW!



(Black Finish)

10 x 3/4"
15/32" O.D. Washer Head
Phillips Flat Top Washer Head
Trim Screws

50 Pcs.

9498PK

NEW!



(Black Finish)

10 x 1"
15/32" O.D. Washer Head
Phillips Flat Top Washer Head
Trim Screws

50 Pcs.

10631PK

NEW!



(Black Finish)

10 x 1 1/4"
15/32" O.D. Washer Head
Phillips Flat Top Washer Head
Trim Screws

50 Pcs.

10725PK

NEW!



(Black Finish)

8 x 1/2"
1/2" O.D. Washer Head
Phillips Flat Top Washer Head
Trim Screws

100 Pcs.

2970PK



(Black Finish)

8 x 3/4"
1/2" O.D. Washer Head
Phillips Flat Top Washer Head
Trim Screws

100 Pcs.

Metropolitan Supply

2975PK



(Black Finish)

8 x 1"
1/2" O.D. Washer Head
Phillips Flat Top Washer Head
Trim Screws

100 Pcs.

9205PK



(Black Finish)

10 x 1/2"
1/2" O.D. Washer Head
Phillips Flat Top Washer Head
Trim Screws

100 Pcs.

9145PK



(Black Finish)

10 x 3/4"
1/2" O.D. Washer Head
Phillips Flat Top Washer Head
Trim Screws

50 Pcs.

9146PK



(Black Finish)

10 x 1"
1/2" O.D. Washer Head
Phillips Flat Top Washer Head
Trim Screws

50 Pcs.

5970PK



(Black Heavy Phosphate Finish)

8 x 3/4"
1/2" O.D. Washer Head
Phillips Flat Top Washer Head
Trim Screws

100 Pcs.

5975PK



(Black Heavy Phosphate Finish)

8 x 1"
1/2" O.D. Washer Head
Phillips Flat Top Washer Head
Trim Screws

100 Pcs.

Metropolitan Supply

1695PK



(Black Finish)

4.2 x 13mm
11mm O.D. Washer Head
Phillips Oval Washer Head
Trim Screws

50 Pcs.

10763PK



(Black Finish)

4.8-1.61 x 16mm
14mm O.D. Washer Head
Phillips Truss Head
Sheet Metal Screws

100 Pcs.

9256PK



(Black Finish)

4.8-1.6 x 15mm
14mm O.D. Washer Head
Phillips Truss Head
Sheet Metal Screws

50 Pcs.

10692PK



(Black Finish)

4.8-2.12 x 20mm
14mm O.D. Washer Head
Phillips Truss Head
Sheet Metal Screws

50 Pcs.

9260PK



(Black Finish)

6.3-1.81 x 16mm
15mm O.D. Washer Head
Phillips Truss Head
Sheet Metal Screws

50 Pcs.

9871PK



(Black Finish)

8 x 3/4"
1/2 " O.D. Loose Washer
Phillips Pan Head
Sheet Metal Screws

50 Pcs.

Metropolitan Supply

10365PK

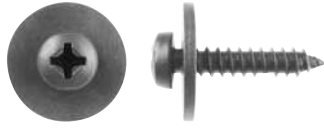

(Black Finish)

4.2-1.41 x 20mm
16mm O.D. Loose Washer
Phillips Pan Head L/Washer
Sheet Metal Screws

50 Pcs.

10096PK

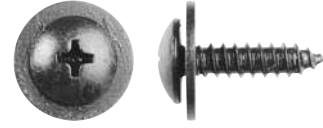

(Black Finish)

4.8-1.60 x 19mm
16mm O.D. Loose Washer
Phillips Truss L/Washer Head
Trim Screws

25 Pcs.

9700PK



(Black Finish)

8 x 3"
Phillips Bugle Head
Course Thread
Dry Wall Screws
50 Pcs.

7002PK



(Chrome Finish)

4.2-1.41 x 20mm
7mm Oval Head
Stainless Steel
Metric Torx® Trim Screws

50 Pcs.

7004PK



(Chrome Finish)

4.2-1.41 x 30mm
7mm Oval Head
Stainless Steel
Metric Torx® Trim Screws

50 Pcs.

7001PK



(Black Finish)

4.2-1.41 x 20mm
7mm Oval Head
Stainless Steel
Metric Torx® Trim Screws

50 Pcs.

Metropolitan Supply

7005PK



(Black Finish)

4.2-1.41 x 30mm
7mm Oval Head
Stainless Steel
Metric Torx® Trim Screws

50 Pcs.

7006PK



(Chrome Finish)

4.2-1.41 x 25mm
8mm Pan Head
Stainless Steel
Metric Torx® Trim Screws

50 Pcs.

7007PK



(Black Finish)

4.2-1.41 x 25mm
8mm Pan Head
Stainless Steel
Metric Torx® Trim Screws

50 Pcs.

511PK



(Bright Zinc Finish)

10 x 1 1/2"
5/16" Hex Head
Sheet Metal Screws
(Used in Body Pulling Tools)

100 Pcs.

9887PK



(Black Finish)

4.2-1.41 x 16mm
7mm Indented Hex Head
12mm O.D. Loose Washer
Sheet Metal Screws

100 Pcs.

5925PK



(Black Finish)

4.2-1.41 x 20mm
12mm O.D. Loose Washer
7mm Indented Hex Head
Sheet Metal Screws

50 Pcs.

Metropolitan Supply

5550PK



(Black Finish)

4.2-1.41 x 20mm
17mm O.D. Loose Washer
7mm Indented Hex Head
Sheet Metal Screws

50 Pcs.

9888PK



(Black Finish)

4.2-1.41 x 20mm
12mm O.D. Loose Washer
7mm Indented Head Head
Sheet Metal Screws

50 Pcs.

10684PK

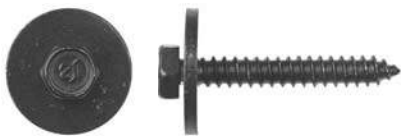

(Black Finish)

4.2-1.41 x 30mm
17mm O.D. Loose Washer
7mm Hex Size
Hex Head Sems Screws

15 Pcs.

10693PK

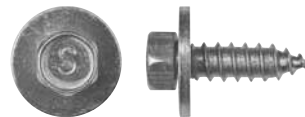

(Yellow Zinc Finish)

5.5-1.81 x 18mm
15mm O.D. Loose Washer
8mm Hex Size
Hex Head Sems Screws

50 Pcs.

10682PK

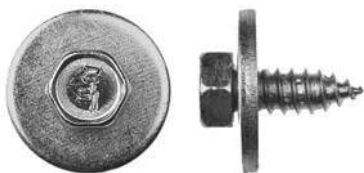

(Yellow Zinc Finish)

6.3-1.81 x 18mm
22mm O.D. Loose Washer
10mm Hex Size
Hex Head Sems Screws

25 Pcs.

10694PK



(Black Finish)

6.3-1.81 x 20mm
16mm O.D. Loose Washer
10mm Hex Head Phillips
Hex Head Sems Screws

50 Pcs.

Metropolitan Supply

5554PK



(Black Finish)

4.2-1.41 x 20mm
12mm O.D. Loose Washer
7mm Indented Hex Head
Teks® Screws

50 Pcs.

5552PK



(Black Finish)

4.2-1.41 x 20mm
17mm O.D. Loose Washer
7mm Indented Hex Head
Teks® Screws

50 Pcs.

10685PK



(Yellow Zinc Finish)

10 x 3/4"
19/32" O.D. Loose Washer
5/16" Hex Size
Hex Head Sems Screws

50 Pcs.

9869PK



(Bright Zinc Finish)

14 x 3/4"
5/8" O.D. Loose Washer
3/8" Indented Hex Head
Sheet Metal Screws

100 Pcs.

10695PK



(Black Finish)

6.3-1.81 x 20mm
20mm O.D. Loose Washer
10mm Hex Head Phillips
Hex Head Sems Screws

50 Pcs.

5950PK



(Black Finish)

6.3-1.81 x 20mm
17mm O.D. Loose Washer
10mm Indented Hex Washer Head
Sheet Metal Screws

50 Pcs.

10683PK

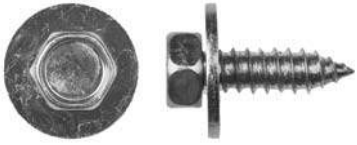

(Yellow Zinc Finish)

6.3-1.81 x 20mm
18mm O.D. Loose Washer
10mm Hex Size
Hex Head Sems Screws

25 Pcs.

5955PK

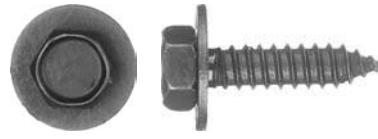

(Black Finish)

6.3-1.81 x 25mm
11/16" O.D. Loose Washer
10mm Indented Hex Head
Sheet Metal Screws

50 Pcs.

5956PK



(Black Phosphate Finish)

6.3-1.81 x 25mm
24mm O.D. Loose Washer
10mm Indented Hex Head
Sheet Metal Screws

25 Pcs.

1620PK



(Bright Zinc Finish)

1/4" (14) x 3/4"
1/2" O.D. Washer Head
3/8" Indented Hex Head Slotted
License Plate Screws

50 Pcs.

9903



1/4" (14) x 3/4"
1/2" O.D. Washer Head
3/8" Indented Hex Head Slotted
License Plate Screw
and Nylon Nut

25 Pcs.

9934PK



(Black Finish)

1/4" (14) x 3/4"
1/2" O.D. Washer Head
3/8" Indented Hex Head Slotted
License Plate Screws

50 Pcs.

Metropolitan Supply

2123PK



(Yellow Zinc Finish)

1/4" (14) X 3/4"
1/2" O.D. Washer Head
10mm Indented Hex Head Phillips
License Plate Screws

50 Pcs.

1939PK



(Black Finish)

1/4" (14) x 5/8"
5/8" O.D. Washer
5/16" Indented Hex Head Slotted
License Plate Screws

50 Pcs.

477PK



(Bright Zinc Finish)

1/4" (14) x 3/4"
9/16" Head Diameter
Slotted Truss Head
License Plate Screws

100 Pcs.

2062PK



(Black Finish)

1/4" (14) x 3/4"
9/16" Head Diameter
Slotted Truss Head
License Plate Screws

100 Pcs.

2121PK



(Bright Zinc Finish)

1/4" (14) x 3/4"
9/16" Head Diameter
Phillips Truss Head
License Plate Screws

50 Pcs.

10455PK



(Silver Dacromet Finish)

6.3-1.81 x 16mm
Duo Drive Truss Head
License Plate Screws

50 Pcs.

10514PK

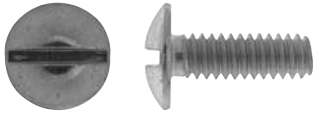

(Bright Zinc Finish)

1/4-20 x 3/4"
9/16" Head Diameter
Slotted Truss Head
License Plate Screws

100 Pcs.

11141PK

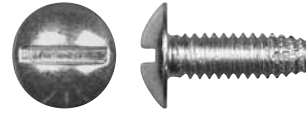

(Bright Zinc Finish)

1/4-20 x 3/4"
Truss Head Slotted
Type F Point
License Plate Screws
50 Pcs.

10555



1/4-20 x 3/4"
9/16" Head Diameter
Slotted Truss Head
License Plate Screw and Nylon Nut

50 Pcs. Each

1650PK



1/4" (14) x 1/2"
1 1/8" Overall Length
Dealer License Plate
Thumb Screws

25 Pcs.

2124PK



(Bright Zinc Finish)

6 -1.00 x 16mm
10mm Hex Size
Hex Washer Head Slotted
License Plate Screws

50 Pcs.

9882PK



(Black Nylon)

1/4-20 x 5/8"
Truss Slot Washer Head
License Plate Screws

50 Pcs.

Metropolitan Supply

9839PK



(Black Nylon)

6-1.00 x 16mm
Pan Head Slotted
License Plate Screws

100 Pcs.

9840PK

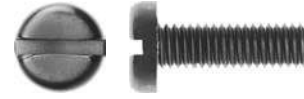

(Black Nylon)

6-1.00 x 20mm
Pan Head Slotted
License Plate Screws

100 Pcs.

9838PK



(Black Nylon)

6-1.00mm
10mm Hex Size
Hex Nuts

100 Pcs.

9836



(Black Nylon)

6 -1.00 x 16mm
Slotted Screw with Hex Nuts
License Plate Screw Kits

50 Pcs.

9837



(Black Nylon)

6 -1.00 x 20mm
Screw with Hex Nuts
License Plate Screw Kits

50 Pcs.

10791PK

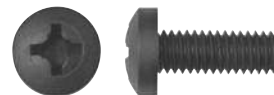

(Black Nylon)

6-1.00 x 16mm
Pan Head Phillips
License Plate Screws

100 Pcs.

10095PK



(Black Nylon)

6-1.00 x 20mm
Pan Head Phillips
License Plate Screws

100 Pcs.

10888PK

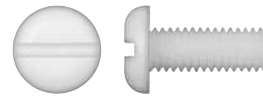

(Natural Nylon)

6-1.00 x 16mm
Pan Head Slotted
License Plate Screws
100 Pcs.

9210PK



(Bright Zinc Finish)

1/4-20 x 3/4"
Phillips Oval Head
Machine Screws

50 Pcs.



Phillips Pan Head Bright Zinc Finish Machine Screws

Part Number	Size	Pkg Qty
10001PK	6-32 x 3/8"	100
10002PK	6-32 x 1/2"	100
10003PK	6-32 x 3/4"	100
10004PK	6-32 x 1"	100
10005PK	6-32 x 1 1/4"	100
10006PK	6-32 x 1 1/2"	100
10007PK	8-32 x 3/8"	100
10008PK	8-32 x 1/2"	100
10009PK	8-32 x 3/4"	100
10010PK	8-32 x 1"	100
10011PK	8-32 x 1 1/2"	100
10012PK	10-24 x 3/8"	100
10013PK	10-24 x 1/2"	100
10014PK	10-24 x 3/4"	100
10015PK	10-24 x 1"	100
10016PK	10-24 x 1 1/4"	100
10017PK	10-24 x 1 1/2"	50
10018PK	10-32 x 3/8"	100
10019PK	10-32 x 1/2"	100
10020PK	10-32 x 3/4"	100
10021PK	10-32 x 1"	100
10022PK	10-32 x 1 1/4"	100
10023PK	10-32 x 1 1/2"	50
10024PK	1/4-20 x 1/2"	100
10025PK	1/4-20 x 3/4"	100
9166PK	1/4-20 x 7/8"	100
10026PK	1/4-20 x 1"	50
10027PK	1/4-20 x 1 1/4"	50
10028PK	1/4-20 x 1 1/2"	50
10029PK	1/4-20 x 1 3/4"	50
10030PK	1/4-20 x 2"	50

9641PK



(Bright Zinc Finish)

1/4-20 X 1 1/4"
Phillips Oval Head
Machine Screws

50 Pcs.

Metropolitan Supply



**Phillips Pan Head
Zinc Finish
Machine Screws
Din # 7985**

Part Number	Size	Pkg Qty
10385PK	5-.80 x 12mm	100
10195PK	5-.80 x 16mm	100
2136PK	6-1.0 x 12mm	100
1851PK	6-1.0 x 16mm	50
9168PK	6-1.0 x 20mm	50

10031PK



(Bright Zinc Finish)

**8 x 3/4"
Phillips Cap Type
Trim Screws
Used with # 10032
100 Pcs.**

10032PK



**3/8" O.D.
Black Nylon
Screw Caps
Used with # 10031
100 Pcs.**

485PK



(Bright Zinc Finish)

**6 x 3/4"
Phillips Pan Head
Sheet Metal Screws
100 Pcs.**

10034PK



**Install with a 6 Screw
Clear Nylon
Screw Bases
Used with # 10033
50 Pcs.**

10033PK



**1/2" O.D.
Black Nylon
Screw Caps
Used with # 10034
50 Pcs.**



***Standard &
Metric
Fasteners***

Metropolitan Supply

204PK



1/4-20 x 15/16"
3/4" O.D. Loose Washer
7/16" Indented Hex Head
Black Finish
Dog Point Body Bolts

50 Pcs.

9417PK



1/4-20 x 1"
5/8" O.D. Loose Washer
7/16" Indented Hex Head
Black Finish
Dog Point Body Bolts

50 Pcs.

9867PK



5/16-18 x 3/4"
13/16" O.D. Flange Size
1/2" Hex Size
Black Finish
Dog Point Spin Lock Bolts

100 Pcs.

210PK



5/16-18 x 13/16"
21/32" O.D. Flange Size
1/2" Indented Hex Head
Black Finish
Type CA Body Bolts

50 Pcs.

9868PK



5/16-18 x 1"
13/16" O.D. Flange Size
1/2" Hex Size
Black Finish
Dog Point Spin Lock Bolts

50 Pcs.

9890PK

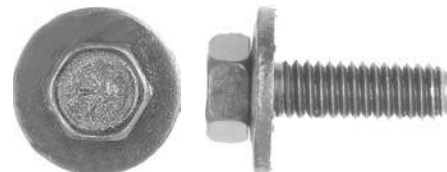

5/16-18 x 1"
7/8" O.D. Loose Washer
1/2" Indented Hex Head
Black Finish
Body Bolts

100 Pcs.

Metropolitan Supply

9249PK

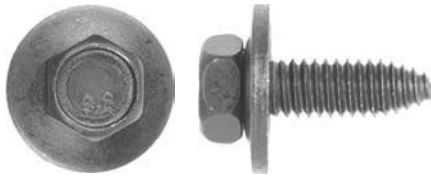

5/16-18 x 1"
7/8" O.D. Loose Washer
1/2" Indented Hex Head
Black Finish
Type CA Body Bolts

25 Pcs.

206PK

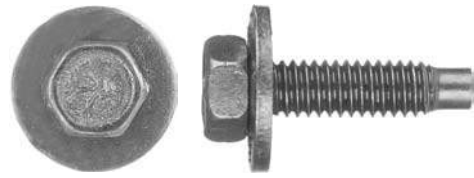

5/16-18 x 1 3/16"
7/8" O.D. Loose Washer
1/2" Indented Hex Head
Black Finish
Dog Point Body Bolts

25 Pcs.

1000PK

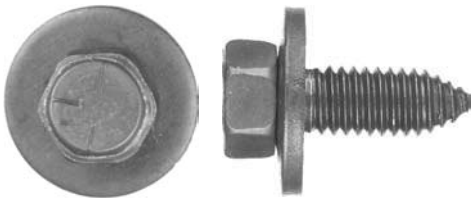

3/8-16 x 1"
1" O.D. Loose Washer
9/16" Indented Hex Head
Black Finish
Type CA Body Bolts

25 Pcs.

1001PK

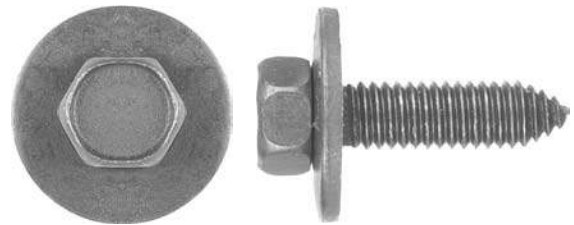

3/8-16 x 1 1/2"
1 1/8" O.D. Loose Washer
9/16" Indented Hex Head
Black Finish
Type CA Body Bolts

25 Pcs.

10970PK



5-.80 x 20mm
12mm O.D. Loose Washer
8mm Hex Size
Black Finish
Metric Dog Point Body Bolts

50 Pcs.

10097PK

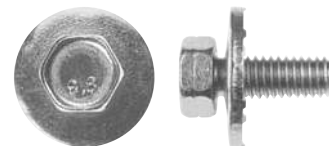

6-1.00 x 16mm
18.5mm O.D. Loose Washer
10mm Indented Hex Head
Zinc and Yellow Finish
Metric Body Bolts

50 Pcs.

Metropolitan Supply

5682PK



6-1.00 x 20mm
13mm O.D. Flange Size
10mm Indented Hex Head
Black Finish
Metric Type CA Flange Bolts

50 Pcs.

9889PK

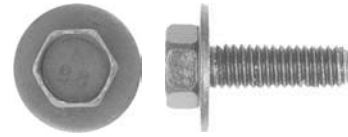

6-1.00 x 20mm
17mm O.D. Flange Size
10mm Indented Hex Head
Black Finish
Metric Body Bolts

50 Pcs.

5684PK



6-1.00 x 20mm
17mm O.D. Loose Washer
10mm Indented Hex Head
Black Finish
Metric Type CA Body Bolts

50 Pcs.

5698PK



6-1.00 x 22mm
19mm O.D. Loose Washer
8mm Indented Hex Head
Black Finish
Metric Dog Point Body Bolts

25 Pcs.

5686PK



6-1.00 x 25mm
17mm O.D. Loose Washer
10mm Indented Hex Head
Black Finish
Metric Type CA Body Bolts

50 Pcs.

5690PK

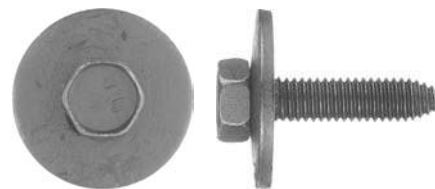

6-1.00 x 25mm
24mm O.D. Loose Washer
10mm Indented Hex Head
Black Finish
Metric Type CA Body Bolts

50 Pcs.

Metropolitan Supply

5699PK

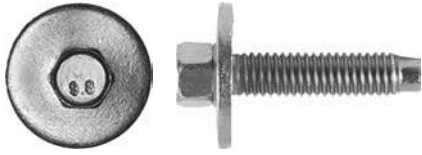

6-1.00 x 28mm
19mm O.D. Loose Washer
8mm Indented Hex Head
Zinc and Yellow Finish
Metric Dog Point Body Bolts

25 Pcs.

5705PK



6-1.00 x 28mm
19mm O.D. Loose Washer
8mm Indented Hex Head
Black Finish
Metric Dog Point Body Bolts

25 Pcs.

5692PK



6-1.00 x 35mm
17mm O.D. Loose Washer
10mm Indented Hex Head
Black Finish
Metric Type CA Body Bolts

50 Pcs.

1013PK



8-1.25 x 25mm
16mm O.D. Flange Size
13mm Indented Hex Head
Black Finish
Metric Type CA Body Bolts

25 Pcs.

9147PK



8-1.25 x 25mm
24mm O.D. Loose Washer
13mm Indented Hex Head
Black Finish
Metric Type CA Body Bolts

25 Pcs.

5695PK



8-1.25 x 30mm
17mm O.D. Flange Size
13mm Indented Hex Head
Zinc Finish
Metric Type CA Body Bolts

25 Pcs.

Metropolitan Supply

5688PK

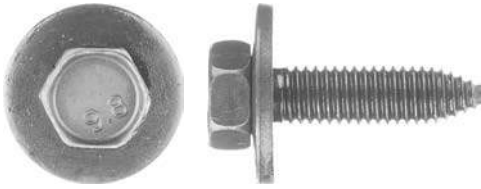

8-1.25 x 30mm
24mm O.D. Loose Washer
13mm Indented Hex Head
Black Finish
Metric Type CA Body Bolts

25 Pcs.

5697PK



8-1.25 x 30mm
17mm O.D. Flange Size
13mm Indented Hex Head
Black Finish
Metric Type CA Body Bolts

25 Pcs.

9064PK

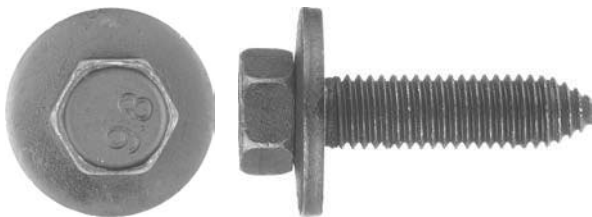

10-1.50 x 40mm
28mm O.D. Loose Washer
15mm Indented Hex Head
Black Finish
Metric Type CA Body Bolts

25 Pcs.

240PK



5/16-18 x 1"
3/4" Head Diameter
Round Style Head
Stainless Steel Capped
Bumper Bolts

25 Pcs.

855PK



3/8-16 x 1"
7/8" Head Diameter
Pan Style Head
Stainless Steel Capped
Bumper Bolts

25 Pcs.

9314PK



3/8-16 x 1 1/4"
7/8" Head Diameter
Round Style Head
Stainless Steel Capped
Bumper Bolts

25 Pcs.

Metropolitan Supply

233PK



7/16-14 x 1 1/2"
29/32" Head Diameter
Round Style Head
Stainless Steel Capped
Bumper Bolts

10 Pcs.

231PK



1/2-13 x 1 1/2"
1 3/32" Head Diameter
Round Style Head
Stainless Steel Capped
Bumper Bolts

25 Pcs.

9275PK

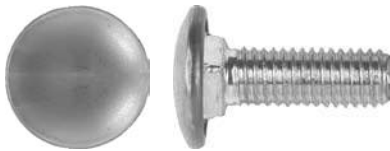

8-1.25 x 25mm
19mm Head Diameter
Pan Style Head
Stainless Steel Capped
Bumper Bolts

25 Pcs.

9877PK



1/4-20 x 7/8"
5/8" O.D. Flange Size
3/8" Indented Hex Head
Black Finish
Truck Mirror Mounting Screws

25 Pcs.

1282PK



1/4-20" Thread Size
3/16" Grip Range
Non Sealing Type
Steel Jack Nuts

25 Pcs.

9541PK



1/4-20 x 1"
5/8" O.D. Loose Washer
Chrome Finish
Outside Mirror Mounting Bolts
Use with # 9371

25 Pcs.

Metropolitan Supply

9371PK



1/4-20" Thread Size
3/16" Grip Range
Raintite Sealer Type
Steel Jack Nuts

25 Pcs.

9561PK



1/4-20 x 1" Screw Size
Mirror Mounting
Screw & Jack Nut Assembly

10 Pcs.

1589PK



6-1.00 x 26mm
Chrome Finish
Outside Mirror
Mounting Bolts
Use with # 1793

25 Pcs.

1793PK



6-1.00mm
Roof Rack Mounting
Raintite Sealer Type
Steel Jack Nuts

10 Pcs.

10035PK



8-32 Screw Size
5/16" Hole Size
7/16" Stem Length
7/16" Flange Diameter
Black Rubber Well Nuts

25 Pcs.

9891PK



10-32 Screw Size
3/8" Hole Size
33/64" Stem Length
1/2" Flange Diameter
Black Rubber Well Nuts

25 Pcs.

Metropolitan Supply

9543PK



1/4-20 x 1" #10 Head
Phillips Oval Head
Stainless Steel
Roof Rack Machine Screws
Use with # 1095

25 Pcs.

1095PK



1/4-20" Screw Size
1/2" Hole Size
9/16" Stem Length
5/8" Flange Diameter
Black Rubber Well Nuts

25 Pcs.

9542PK



6-1.00 x 26mm #10 Head
Phillips Oval Head
Stainless Steel
Roof Rack Machine Screws
Use with # 1284

25 Pcs.

1284PK



6-1.00mm Screw Size
12.5mm Hole
16mm Stem Length
5/8" Flange Diameter
Black Rubber Well Nuts

10 Pcs.

101PK



10-24 Screw Size
3/8" Hex Size
Bright Zinc Finish
Machine Screw Nuts
100 Pcs.



Bright Zinc Finish
Nylon Insert Lock Nuts

Part Number	Size	Hex Size	Pkg Qty
9759PK	5/16-18 (USS)	1/2"	100
9819PK	5/16-24 (SAE)	1/2"	50
10344PK	3/8-16 (USS)	9/16"	50
9984PK	7/16-14 (USS)	5/8"	25

4040PK



3/8" Shaft Diameter
 .303 Groove Dia.
 .039" Groove Width
 Black Finish
 "E" Type Retaining Rings
 100 Pcs.

4125PK



3/8" Bolt Size
 11/16" Outside Diameter
 Internal Tooth
 Bright Zinc Finish
 Lockwashers
 100 Pcs.



**Bright Zinc Finish
 Finished Hex Nuts**

Part Number	Size	Wrench Size	Pkg Qty
1313PK	1/4 -20	7/16"	100
1314PK	5/16-18	1/2"	100
1315PK	3/8 -16	9/16"	100
1316PK	7/16-14	11/16"	100
1317PK	1/2 -13	3/4"	100



**Grade 5
 Bright Zinc Finish
 Hex Cap Screws**

Part Number	Size	Pkg Qty
1330PK	1/4 -20 x 1/2"	100
1331PK	1/4 -20 x 3/4"	100
1332PK	1/4 -20 x 1"	100
1333PK	1/4 -20 x 1 1/4"	100
1334PK	1/4 -20 x 1 1/2"	100
1335PK	1/4 -20 x 2"	100
1336PK	5/16-18 x 3/4"	100
1337PK	5/16-18 x 1"	100
1338PK	5/16-18 x 1 1/4"	100
1339PK	5/16-18 x 1 1/2"	100
1340PK	5/16-18 x 2"	50
1341PK	5/16-18 x 2 1/2"	50
1342PK	3/8 -16 x 1"	50
1343PK	3/8 -16 x 1 1/4"	50
1344PK	3/8 -16 x 1 1/2"	50
1345PK	3/8 -16 x 2"	50
1346PK	3/8 -16 x 2 1/2"	50
1347PK	3/8 -16 x 3"	50
10277PK	3/8 -16 x 3 1/2"	50
1348PK	7/16-14 x 1"	25
1349PK	7/16-14 x 1 1/4"	25
9749PK	7/16-14 x 1 1/2"	25
1351PK	7/16-14 x 2"	25
1352PK	1/2 -13 x 1 1/2"	25
1353PK	1/2 -13 x 2"	25
1354PK	1/2 -13 x 2 1/2"	25
1355PK	1/2 -13 x 3"	25

Metropolitan Supply



**Bright Zinc Finish
USS Flatwashers**

Part Number Bolt Size I.D. O.D. Pkg Qty

1319PK	1/4"	5/16"	3/4"	100
1320PK	5/16"	3/8"	7/8"	100
1321PK	3/8"	7/16"	1"	100
1322PK	7/16"	1/2"	1 1/4"	100
1323PK	1/2"	9/16"	1 3/8"	100



**Bright Zinc Finish
Fenderwashers**

Part Number Bolt Size O.D. Thickness Pkg Qty

149PK	1/4"	1"	1/16"	100
148PK	1/4"	1 1/4"	3/64"	100
147PK	1/4"	1 1/2"	3/64"	50
146PK	5/16"	1 1/4"	3/64"	100
145PK	5/16"	1 1/2"	3/64"	50



**Bright Zinc Finish
SAE Flatwashers**

Part Number Bolt Size I.D. O.D. Pkg Qty

1364PK	1/4"	9/32"	5/8"	100
1365PK	5/16"	11/32"	11/16"	100
1366PK	3/8"	13/32"	13/16"	100
1367PK	7/16"	15/32"	15/16"	100
1368PK	1/2"	17/32"	1 1/16"	100

9958PK

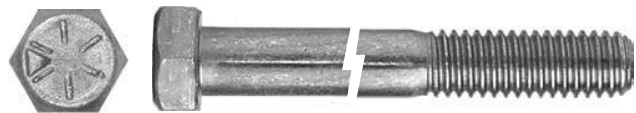

**3/8-16" x 4"
Grade 8
Hex Head
Bright Zinc Finish
Cap Screws
25 Pcs.**

256PK



**3/8-16" (USS) Bolt Size
3/4" O.D. Flange
9/16" Hex Size
Zinc Finish
Serrated Flange Nuts
100 Pcs.**



**Bright Zinc Finish
Spring Steel
Standard Lockwashers**

Part Number Size Pkg Qty

1325PK	1/4"	100
1326PK	5/16"	100
1327PK	3/8"	100
1328PK	7/16"	100
1329PK	1/2"	50



**180,000 P.S.I.
Tensile Strength
Grade 9
Bright Yellow Zinc Finish
Body & Frame Clamp
Replacement Bolts
Made in the USA**

Part Number	Size	Pkg Qty
9884PK	1/2-13 x 2" (USS)	5
10404PK	1/2-13 x 2 1/2" (USS)	5
9806PK	1/2-13 x 3" (USS)	5
9741PK	5/8-11 x 3" (USS)	5
9742PK	5/8-11 x 3 1/2" (USS)	5
9743PK	5/8-11 x 4" (USS)	5
9744PK	5/8-11 x 4 1/2" (USS)	5

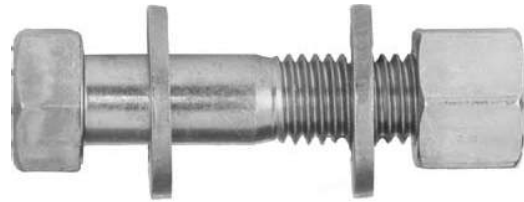

**Grade 9
Bright Yellow Zinc Finish
Body & Frame Clamp
Replacement Bolt Kits
Made in the USA**

Contains: 2 Bolts, 2 Nuts, 4 Flat Washers

Part Number	Size	Pkg Qty
9970	1/2-13 x 2"	1 Kit
9971	1/2-13 x 3"	1 Kit
1539	5/8-11 x 3"	1 Kit
1540	5/8-11 x 3 1/2"	1 Kit
1541	5/8-11 x 4"	1 Kit
1542	5/8-11 x 4 1/2"	1 Kit

Contains: 16 Bolts, 16 Nuts, 16 Flat Washers

Part Number	Size	Pkg Qty
10380	1/2-13 x 2 1/2"	1 Kit
10381	5/8-11 x 3 1/2"	1 Kit



**Grade 9
Bright Yellow Zinc Finish
Body & Frame Clamp
Replacement Special
Tall Nuts
Made in the USA**

Part Number	Size	Pkg Qty
9807PK	1/2-13 (USS)	10
9739PK	5/8-11 (USS)	10



**Grade 9
Bright Yellow Zinc Finish
Body & Frame Clamp
Replacement
Thick Flatwashers
Made in the USA**

Part Number	Size	Pkg Qty
9808PK	1/2 (SAE)	20
9740PK	5/8 (SAE)	20

Hammerlock Type Zinc Plated Cotter Pins

Insert

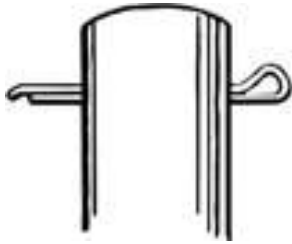

Insert as you would any ordinary cotter pin. Hob-Lok pins have specially tapered parallel shanks for quick insertion.

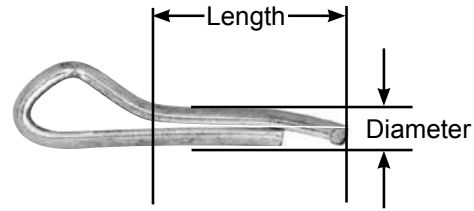

Hit with Hammer



Shanks Spread and Lock Themselves

When hammer hits head of Hob-Lok pin, it forces the shorter shank down over the curved end of the longer shank, thus causing the lower ends of the shanks to spread apart. This simple operation locks the pin securely in place. No twisting or spreading of the shanks is necessary. It is all done automatically!

Twist to Remove

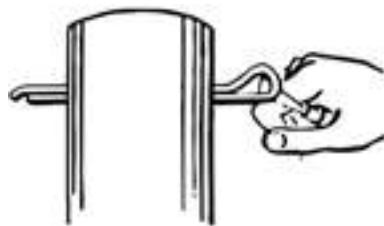

To remove, insert any small tool in eye of Hob-Lok pin. Twist shorter shank to original position and remove.

Part Number	Size	Pkg Qty
4062PK	1/16 x 3/4"	200
4063PK	1/16 x 1"	200
4064PK	1/16 x 1 1/4"	200
4065PK	1/16 x 1 1/2"	200
4067PK	1/16 x 2"	200
4069PK	3/32 x 3/4"	200
4070PK	3/32 x 1"	200
4071PK	3/32 x 1 1/4"	200
4072PK	3/32 x 1 1/2"	200
4074PK	3/32 x 2"	200
4084PK	1/8 x 3/4"	200
4086PK	1/8 x 1"	200
4087PK	1/8 x 1 1/4"	200
4088PK	1/8 x 1 1/2"	200
4089PK	1/8 x 1 3/4"	200
4090PK	1/8 x 2"	200
4091PK	1/8 x 2 1/2"	200
4094PK	5/32 x 1"	100
4095PK	5/32 x 1 1/4"	100
4096PK	5/32 x 1 1/2"	100
4098PK	5/32 x 2"	100
4100PK	5/32 x 2 1/2"	100
4103PK	3/16 x 1"	100
4105PK	3/16 x 1 1/2"	100
4107PK	3/16 x 2"	100
4108PK	3/16 x 2 1/2"	100
4112PK	1/4 x 1"	100
4114PK	1/4 x 1 1/2"	100
4116PK	1/4 x 2"	100



**Bright Zinc Finish
Class 8.8
Hex Head Cap Screws
Din# 933 (Fully Threaded)
Din# 931 (Partially Threaded)**

Part Number	Size	Thread Pitch	Wrench Size	Din Number	Pkg Qty
869PK	4 x 16mm	.70	7mm	933	50
870PK	4 x 20mm	.70	7mm	933	50
871PK	5 x 10mm	.80	8mm	933	50
872PK	5 x 16mm	.80	8mm	933	50
873PK	5 x 20mm	.80	8mm	933	50
874PK	5 x 25mm	.80	8mm	933	50
875PK	5 x 30mm	.80	8mm	933	25
876PK	6 x 10mm	1.00	10mm	933	50
9765PK	6 x 16mm	1.00	10mm	933	25
877PK	6 x 20mm	1.00	10mm	933	25
878PK	6 x 25mm	1.00	10mm	933	25
879PK	6 x 30mm	1.00	10mm	933	25
880PK	6 x 35mm	1.00	10mm	931	25
881PK	6 x 40mm	1.00	10mm	931	25
9766PK	6 x 50mm	1.00	10mm	931	25
884PK	8 x 12mm	1.25	13mm	933	25
885PK	8 x 16mm	1.25	13mm	933	25
886PK	8 x 20mm	1.25	13mm	933	25
887PK	8 x 25mm	1.25	13mm	933	25
888PK	8 x 30mm	1.25	13mm	933	25
889PK	8 x 40mm	1.25	13mm	931	25
890PK	8 x 50mm	1.25	13mm	931	25
891PK	8 x 60mm	1.25	13mm	931	25
892PK	8 x 70mm	1.25	13mm	931	10



**Bright Zinc Finish
Class 8.8
Hex Head Cap Screws
Din# 933 (Fully Threaded)
Din# 931 (Partially Threaded)**

Part Number	Size	Thread Pitch	Wrench Size	Din Number	Pkg Qty
893PK	10 x 20mm	1.50	17mm	933	25
894PK	10 x 25mm	1.50	17mm	933	25
895PK	10 x 30mm	1.50	17mm	933	25
896PK	10 x 35mm	1.50	17mm	933	15
897PK	10 x 40mm	1.50	17mm	931	15
899PK	10 x 50mm	1.50	17mm	931	15
900PK	10 x 60mm	1.50	17mm	931	10
903PK	12 x 25mm	1.75	19mm	933	10
904PK	12 x 30mm	1.75	19mm	933	10
905PK	12 x 40mm	1.75	19mm	933	10
906PK	12 x 50mm	1.75	19mm	931	10
907PK	12 x 60mm	1.75	19mm	931	10



**Bright Zinc Finish
Class 8
Metric Hex Nuts
Din# 934**

Part Number	Size	Thread Pitch	Wrench Size	Pkg Qty
861PK	4mm	.70	7mm	50
862PK	5mm	.80	8mm	50
863PK	6mm	1.00	10mm	100
865PK	8mm	1.25	13mm	100
866PK	10mm	1.50	17mm	50
867PK	12mm	1.75	19mm	25



**Bright Zinc Finish
Spring Steel
Metric Lockwashers
Din# 127**

Part Number	Bolt Size	I.D.	O.D.	Pkg Qty
1658PK	4mm	4.1mm	7.4mm	50
1659PK	5mm	5.1mm	9.0mm	50
1661PK	6mm	6.1mm	11.5mm	100
1662PK	8mm	8.2mm	14.2mm	100
1663PK	10mm	10.2mm	17.5mm	50
1664PK	12mm	12.2mm	20.3mm	25



**Bright Zinc Finish
Metric Flatwashers
Din# 125**

Part Number	Bolt Size	I.D.	O.D.	Pkg Qty
1651PK	4mm	4.3mm	9mm	50
1652PK	5mm	5.3mm	11mm	50
1654PK	6mm	6.4mm	12mm	100
1655PK	8mm	8.4mm	17mm	100
1656PK	10mm	10.5mm	21mm	100
1657PK	12mm	13mm	24mm	25

Metropolitan Supply



**Bright Zinc Finish
Class 10.9
J.I.S. Small Head
Hex Flange Bolts**

Part Number	Size	Thread Pitch	Wrench Size	Flange O.D.	Pkg Qty
3203PK	6 x 12mm	1.00	10mm	14mm	50
3204PK	6 x 16mm	1.00	10mm	14mm	50
3205PK	6 x 20mm	1.00	10mm	14mm	50
3206PK	6 x 25mm	1.00	10mm	14mm	25
3207PK	6 x 30mm	1.00	10mm	14mm	25
3208PK	6 x 35mm	1.00	10mm	14mm	25
3209PK	6 x 40mm	1.00	10mm	14mm	25
9824PK	6 x 45mm	1.00	10mm	14mm	15
3210PK	8 x 12mm	1.25	12mm	17.5mm	25
3211PK	8 x 16mm	1.25	12mm	17.5mm	15
3212PK	8 x 20mm	1.25	12mm	17.5mm	15
3213PK	8 x 25mm	1.25	12mm	17.5mm	15
3214PK	8 x 30mm	1.25	12mm	17.5mm	15
3215PK	8 x 35mm	1.25	12mm	17.5mm	15
3216PK	8 x 40mm	1.25	12mm	17.5mm	15
3217PK	10 x 16mm	1.25	14mm	21mm	10
3218PK	10 x 20mm	1.25	14mm	21mm	10
3219PK	10 x 25mm	1.25	14mm	21mm	10
3220PK	10 x 30mm	1.25	14mm	21mm	10
3221PK	10 x 35mm	1.25	14mm	21mm	10
3222PK	10 x 40mm	1.25	14mm	21mm	10



**Bright Zinc Finish
Class 10
Metric Spin Lock Nuts
Serrated**

Part Number	Size	Thread Pitch	Wrench Size	Flange O.D.	Pkg Qty
3200PK	6mm	1.00	10mm	14mm	50
3201PK	8mm	1.25	12mm	17mm	50
3202PK	10mm	1.25	14mm	20.5mm	25

The image features a variety of metal fasteners, including hex nuts, lock nuts, wing nuts, and nuts with different hole patterns, scattered across a white background. The central text is prominently displayed in a bold, italicized font.

Special Nuts

Metropolitan Supply

688PK

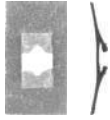

1/8" Stud Size
5/16" x 9/16"
Flat Type
Black Finish
Flat Type Speed Nuts
100 Pcs.

690PK

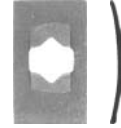

3/16" Stud Size
3/8" x 5/8"
Flat Type
Black Finish
Flat Type Speed Nuts
100 Pcs.

9894PK



10-24" Screw Size
7/16" x 3/4" Plate Size
Black Phosphate
Flat Type Speed Nuts
100 Pcs.

1684PK



1/8" Stud Size
3/8" Flange O.D.
Zinc Finish
Push On Type
Retainers
100 Pcs.

1685PK



5/32" Stud Size
7/16" Flange O.D.
Zinc Finish
Push On Type
Retainers
100 Pcs.

1686PK



3/16" Stud Size
7/16" Flange O.D.
Zinc Finish
Push On Type
Retainers
100 Pcs.

Metropolitan Supply

1687PK



1/4" Stud Size
1 7/32" Flange O.D.
Zinc Finish
Push On Type
Retainers
100 Pcs.

9852PK



5/32" (#8) Bolt Size
3/8" Flange O.D.
Black Finish
Push On Type
Retainers
100 Pcs.

1273PK



1/4" Bolt Size
1/2" Flange O.D.
Black Finish
Push On Type
Retainers
100 Pcs.

1274PK



5/16" Bolt Size
5/8" Flange O.D.
Zinc Finish
Push On Type
Retainers
100 Pcs.

990PK



7/16" Bolt Size
2 7/32" Flange O.D.
Black Finish
Push On Type
Retainers
100 Pcs.

989PK



3/8" Bolt Size
2 5/32" Flange O.D.
Black Finish
Push On Type
Retainers
100 Pcs.

Metropolitan Supply

991PK



1/2" Bolt Size
15/16" Flange O.D.
Black Finish
Push On Type
Retainers
100 Pcs.

9850PK



3.2mm Stud Size
9.5mm Flange O.D.
Zinc Finish
Push On Type
Retainers
100 Pcs.

1691PK



4mm Stud Size
11mm Flange O.D.
Black Finish
Push On Type
Retainers
100 Pcs.

10937PK

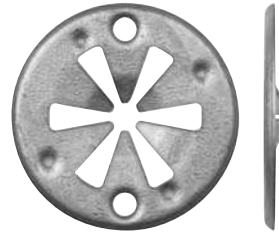

5mm Stud Size
Outside Diameter: 30mm
Dacromet Finish
Push On Type
Retainers
25 Pcs.

1275PK



6 -1.00mm Bolt Size
12.7mm Flange O.D.
Zinc Finish
Push On Type Retainers
Retainers
100 Pcs.

1621PK



6-1.00mm Bolt Size
17mm Flange O.D.
Black Finish
Push On Type
Retainers
100 Pcs.

Metropolitan Supply

1043PK



8-1.25mm Bolt Size
16mm Flange O.D.
Zinc Finish
Push On Type
Retainers

100 Pcs.

3010PK

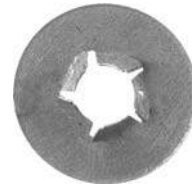

8-1.25mm Bolt Size
24mm Flange O.D.
Dacromet Finish
Push On Type
Bumper Strip
Retainers

50 Pcs.

1276PK



10-1.50mm Bolt Size
24mm Flange O.D.
Dacromet Finish
Push On Type
Retainers

50 Pcs.

1044PK



12-1.75mm Bolt Size
21mm Flange O.D.
Black Finish
Push On Type
Retainers
50 Pcs.

9952PK



14-2.00mm Bolt Size
25mm Flange O.D.
Black Finish
Push On Type
Retainers

50 Pcs.

708PK



1/8" Stud Size
5/32" Hole Size
Black Finish
Barrel Nuts
100 Pcs.

Metropolitan Supply

709PK



1/8" Stud Size
3/16" Hole Size
Black Finish
Barrel Nuts

100 Pcs.

710PK



1/8" Stud Size
1/4" Hole Size
Black Finish
Barrel Nuts

100 Pcs.

9878PK



3/16" Stud Size
7/64" Hole Size
Black Nylon
Barrel Nuts

100 Pcs.

711PK



3/16" Stud Size
7/32" Hole Size
Black Finish
Barrel Nuts

100 Pcs.

9941PK



1/4" Stud Size
9/32" Hole Size
Black Finish
Barrel Nuts

100 Pcs.

265PK



1/8" Stud Size
5/16" Hex Size
17/32" Flange
Zinc Finish
Thread Cutting Nuts
100 Pcs.

Metropolitan Supply

264PK



5/32" Stud Size
11/32" Hex Size
9/16" Flange Size
Zinc Finish
Thread Cutting Nuts
100 Pcs.

9847PK



3/16" Stud Size
3/8" Hex Size
1/2" Flange Size
Zinc Finish
Thread Cutting Nuts
200 Pcs.

263PK



3/16" Stud Size
3/8" Hex Size
5/8" Flange Size
Zinc Finish
Thread Cutting Nuts
100 Pcs.

262PK



1/4" Stud Size
7/16" Hex Size
19/32" Flange Size
Zinc Finish
Thread Cutting Nuts
100 Pcs.

9226PK



1/4" Stud Size
7/16" Hex Size
11/16" Flange Size
Zinc Finish
Thread Cutting Nuts
100 Pcs.

856PK



5/16" Stud Size
1/2" Hex Size
7/8" Flange Size
Zinc Finish
Thread Cutting Nuts
50 Pcs.

Metropolitan Supply

1040PK



4mm Stud Size
9mm Hex Size
15mm Flange Size
Black Finish
Thread Cutting Nuts
100 Pcs.

1041PK



5mm Stud Size
10mm Hex Size
15mm Flange Size
Black Finish
Thread Cutting Nuts

50 Pcs.

1042PK



6.3mm Stud Size
11mm Hex Size
18mm Flange Size
Zinc Finish
Thread Cutting Nuts

50 Pcs.

1622PK



8mm Stud Size
13mm Hex Size
20mm Flange Size
Zinc Finish
Thread Cutting Nuts

100 Pcs.

259PK



10-24 Screw Size
3/8" Hex Size
31/64" O.D. Serrated Washer
Bright Zinc Finish
Hex Flange Nuts
100 Pcs.

9883PK



1/4-20" Screw Size
7/16" Hex Size
Black Nylon
Hex Flange Nuts
50 Pcs.

Metropolitan Supply

5797PK



5-.80mm
8mm Hex Size
11.8mm O.D. Washer
Black Finish
Metric Hex Flange Nuts

50 Pcs.

5800PK



6-1.00mm
10mm Hex Size
16mm O.D. Serrated Washer
Black Finish
Metric Hex Flange Nuts
100 Pcs.

5805PK



8-1.25mm
13mm Hex Size
19mm O.D. Serrated Washer
Black Finish
Metric Hex Flange Nuts
100 Pcs.

1017PK



10-1.50mm
15mm Hex Size
21mm O.D. Washer
Black Finish
Metric Hex Flange Nuts

25 Pcs.

1639PK



5-.80mm
10mm Hex Size
15mm O.D. Loose Washer
Black Finish
Metric Hex Nuts

50 Pcs.

5910PK



6-1.00mm
10mm Hex Size
16mm O.D. Loose Barbed Washer
Black Finish
Metric Hex Nuts

25 Pcs.

Metropolitan Supply

5915PK



6-1.00mm
10mm Hex Size
19mm O.D. Loose Barbed Washer
Black Finish
Metric Hex Nuts

25 Pcs.

10838PK



8-1.25mm
13mm Hex Size
18mm O.D. Loose Barbed Washer
Black Phosphate Finish
Metric Hex Nuts

25 Pcs.

5916XPK



8-1.25mm
13mm Hex Size
24mm O.D. Loose Barbed Washer
Black Finish
Metric Hex Nuts

25 Pcs.

10053PK



6 Screw Size
Panel Range: .090" - .110"
Center of Hole to Edge: 9/32"
Black Phosphate Finish
Short Type "J" Nuts
25 Pcs.

9866PK



8-32 Screw Size
Panel Range: .110" - .125"
Center of Hole to Edge: 9/32"
Black Finish
"U" Type Speed Nuts
Tinnerman # C7112-832-4
25 Pcs.

9897PK



10-24" Screw Size
Panel Range: .045" - .062"
Center of Hole to Edge: 9/16"
Black Finish
"U" Type Speed Nuts
100 Pcs.

9848PK



1/4"-20 Screw Size
Panel Range: .064" - .125"
Center of Hole to Edge: 9/16"
Black Finish
"U" Type Speed Nuts

100 Pcs.

9892PK

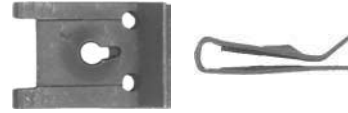

6 Screw Size
Panel Range: .025" - .125"
Center of Hole to Edge: 3/8"
Black Finish
Wide Range "U" Nuts

50 Pcs.

1350PK



8 Screw Size
Panel Range: .020" - .150"
Center of Hole to Edge: 3/8"
Black Finish
Wide Range "U" Nuts

100 Pcs.

1510PK



8 Screw Size
Panel Range: .120" - .250"
Center of Hole to Edge: 3/8"
Black Finish
Wide Range "U" Nuts

100 Pcs.

5750PK



8 Screw Size
Panel Range: .025" - .150"
Center of Hole to Edge: 5/8"
Black Finish
Wide Range "U" Nuts

100 Pcs.

5751PK



10 Screw Size
Panel Range: .025" - .150"
Center of Hole to Edge: 3/8"
Black Finish
Wide Range "U" Nuts

25 Pcs.

Metropolitan Supply

5752PK



10 Screw Size
Panel Range: .025" - .150"
Center of Hole to Edge: 5/8"
Black Finish
Wide Range "U" Nuts
50 Pcs.

1192PK

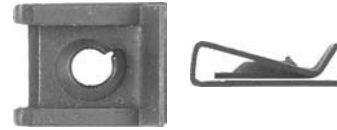

14 Screw Size
Panel Range: .025" - .150"
Center of Hole to Edge: 3/8"
Black Finish
Wide Range "U" Nuts
25 Pcs.

5753PK



14 Screw Size
Panel Range: .025" - .150"
Center of Hole to Edge: 5/8"
Black Finish
Wide Range "U" Nuts
25 Pcs.

1601PK

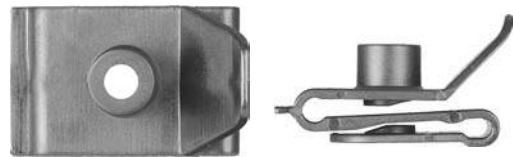

10 Screw Size
Panel Range: Up to 1mm
Center of Hole to Edge: 11mm
Black Nylon
"U" Type Retainers
15 Pcs.

10785PK



6mm Screw Size
16mm Wide 22mm Long
Center of Hole to Edge: 8mm
Black Nylon
Wheel Guard "U" Nuts
25 Pcs.

1606PK

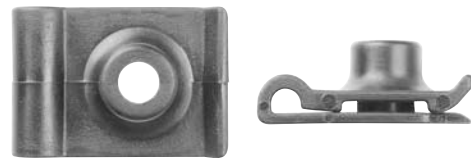

14 (1/4") Screw Size
Panel Range: Up to 1mm
Center of Hole to Edge: 15mm
Black Nylon
Wheel Housing "U" Nuts
15 Pcs.

Metropolitan Supply

938PK



10-24 Screw Size
Panel Range: .025" - .125"
Center of Hole to Edge: 15/32"
Black Finish
Extruded "U" Nuts

50 Pcs.

938ZPK



10-24 Screw Size
Panel Range: .025" - .150"
Center of Hole to Edge: 15/32"
Bright Zinc Finish
Extruded "U" Nuts

50 Pcs.

2969ZYPK



1/4"-20
Panel Range: .010" - .165"
Center of Hole to Edge: 17/32"
Yellow Dichromate Finish
Extruded "U" Nuts

25 Pcs.

2969PK



1/4"-20
Panel Range: .010" - .165"
Center of Hole to Edge: 17/32"
Black Finish
Extruded "U" Nuts

25 Pcs.

10732PK



1/4"-20
Panel Range: .025" - .150"
Center of Hole to Edge: 17/32"
Zinc Organic Finish
Extruded "U" Nuts

25 Pcs.

5480PK



1/4"-20
Panel Range: .010" - .165"
Center of Hole to Edge: 25/32"
Black Finish
Extruded "U" Nuts

25 Pcs.

Metropolitan Supply

1835PK



5/16"-18
Panel Range: .010" - .165"
Center of Hole to Edge: 5/8"
Black Finish
Extruded "U" Nuts

25 Pcs.

1836PK



5/16"-18
Panel Range: .010" - .170"
Center of Hole to Edge: 27/32"
Black Finish
Extruded "U" Nuts

25 Pcs.

5412PK



3/8"-16
Panel Range: .035" - .205"
Center of Hole to Edge: 3/4"
Black Finish
Extruded "U" Nuts

25 Pcs.

5466PK



3/8"-16
Panel Range: .035" - .220"
Center of Hole to Edge: 1 1/8"
Black Finish
Extruded "U" Nuts

25 Pcs.

10795PK



#8 (4.2-1.41mm) Screw Size
Panel Range: .65mm - 3.8mm
Center of Hole to Edge: 9.5mm
Zinc Organic Finish
Extruded "U" Nuts

25 Pcs.

Metropolitan Supply

1012PK

NEW!



5-.80mm
Panel Range: .030" - .160"
Center of Hole to Edge: 5/8"
Black Phosphate Finish
Extruded "U" Nuts

50 Pcs.

9949PK



6-1.00mm
Prevailing Torque
Center of Hole to Edge: 9/16"
Extruded "U" Nuts

25 Pcs.

5596PK



6-1.00mm
Panel Range: .010" - .165"
Center of Hole to Edge: 17/32"
Black Finish
Extruded "U" Nuts

25 Pcs.

9512PK

NEW!



6-1.00mm
Panel Range: .140" - .250"
Center of Hole to Edge: 17/32"
Black Phosphate Finish
Extruded "U" Nuts

25 Pcs.

5650PK



6-1.00mm
Panel Range: .010" - .165"
Center of Hole to Edge: 25/32"
Black Finish
Extruded "U" Nuts

25 Pcs.

5559PK



6.3-1.00mm
Panel Range: .010" - .165"
Center of Hole to Edge: 17/32"
Black Finish
Extruded "U" Nuts

25 Pcs.

Metropolitan Supply

5560PK



8-1.25mm
 Panel Range: .010" - .165"
 Center of Hole to Edge: 9/16"
 Black Finish
 Extruded "U" Nuts

25 Pcs.

5557PK



8-1.25mm
 Panel Range: .010" - .175"
 Center of Hole to Edge: 13/16"
 Black Finish
 Extruded "U" Nuts

25 Pcs.

5558PK



10-1.50mm
 Panel Range: .035" - .232"
 Center of Hole to Edge: 3/4"
 Black Finish
 Extruded "U" Nuts

25 Pcs.

10090PK

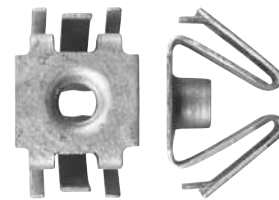

6-1.00mm Screw Size
 Zinc Organic
 Door Trim Panel
 Retainer Nuts

10 Pcs.



**Zinc & Black Finish
 Square Type Cage Nuts
 Standard**



Part Number	Size	Panel Range	Mounting Hole	Finish	Pkg Qty
11005PK	10-24" Screw Size	.025 - .063	3/8"	Zinc	50 Pcs.
11006PK	10-24" Screw Size	.064 - .105	3/8"	Zinc	50 Pcs.
11007PK	10-32" Screw Size	.025 - .063	3/8"	Zinc	50 Pcs.
11008PK	10-32" Screw Size	.064 - .105	3/8"	Zinc	50 Pcs.
11009PK	1/4-20" Screw Size	.025 - .063	3/8"	Zinc	50 Pcs.
11010PK	1/4-20" Screw Size	.064 - .105	3/8"	Zinc	50 Pcs.
11011PK	5/16-18" Screw Size	.093 - .126	1/2"	Zinc	50 Pcs.
11012PK	3/8-16" Screw Size	.093 - .126	1/2"	Zinc	50 Pcs.
11016PK	3/8-24" Screw Size	.057 - .032	1/2"	Black	50 Pcs.



**Zinc Finish
Square Type Cage Nuts
Metric**

Part Number	Size	Panel Range	Mounting Hole	Finish	Pkg Qty
11013PK	5-.80mm Screw Size	1.626 - 2.667	3/8"	Zinc	50 Pcs.
11014PK	6-1.00mm Screw Size	.635 - 1.60	3/8"	Zinc	50 Pcs.
11015PK	6-1.00mm Screw Size	1.626 - 2.667	3/8"	Zinc	50 Pcs.

2157PK



**#4 Screws Size
Hole Size: 7mm
Stem Length: 17mm
Natural Nylon
Center Pillar Screw Grommets**

10 Pcs.

9085PK



**#6 (3.5mm) Screw Size
Panel Range: .060" - .150"
Hole Size: 15/64" Stem: 3/64"
White Nylon
Side Marker Light Nuts**

50 Pcs.

1297PK



**#6 (3.5mm) Screw Size
Hole Size: 9/32"
Stem Length: 5/16"
Natural Nylon
Headlight Bezel Nuts**

50 Pcs.

9111PK



**#6 (3.5mm) Screw Size
Hole Size: 6.5mm x 7.5mm
Stem Length: 8.5mm
Natural Nylon
Headlight Bezel Nuts**

50 Pcs.

Metropolitan Supply

9112PK



#6 (3.5mm) Screw Size
Hole Size: 7mm x 7.5mm
Stem Length: 8mm
Natural Nylon
Screw Grommets

25 Pcs.

10808PK



#6 (3.5mm) Screw Size
Hole Size: 6mm x 14mm
Stem Length: 7mm
White Nylon
Rocker Trim Screw Grommets

25 Pcs.

1636PK



#6 (3.5mm) Screw Size
Hole Size: 7mm
Stem Length: 15mm
Natural Nylon
Screw Grommets

25 Pcs.

2156PK



#6 (3.5mm) Screw Size
Hole Size: 7mm
Stem Length: 6.5mm
Natural Nylon With Sealer
Body Side Screw Grommets

15 Pcs.

9591PK



#6 (3.5mm) Screw Size
Hole Size: 7mm
Stem Length: 10mm
Natural Nylon With Sealer
Screw Grommets

25 Pcs.

10618PK



8mm x 9mm Hole Size
Stem Length: 13mm
White Nylon With Sealer
Cowl Vent Grommets
Use with # 10678

15 Pcs.

Metropolitan Supply

10678PK

NEW!



Stem Diameter: 4.1mm
Stem Length: 15mm
Black Nylon
Cowl Screen Pin Retainers
Use with # 10618

25 Pcs.

10619PK

NEW!

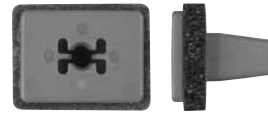

#6 (3.5mm) Screw Size
Hole Size: 12mm x 16mm
Stem Length: 12mm
Blue Nylon With Sealer
Windshield Mldg. Grommets

10 Pcs.

1407PK

NEW!



#6 (3.5mm) Screw Size
Hole Size: 7.1mm x 20.3mm
Stem Length: 16.5mm
Black Nylon
High Torque Screw Grommets

25 Pcs.

9873PK



#6 (3.5mm) Screw Size
Hole Size: 7mm x 7.5mm
Stem Length: 8mm
Headlight Door To
Radiator Grille Anchor Nuts

50 Pcs.

1202PK

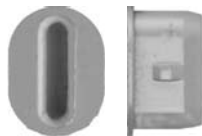

#6 (3.5mm) Screw Size
Hole Size: 7mm x 15mm
Stem Length: 8.5mm
Natural Nylon
Grille Attachment Grommets

50 Pcs.

637PK

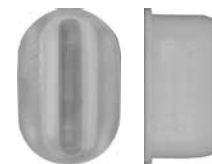

#6 (3.5mm) Screw Size
Hole Size: 7mm x 18.5mm
Natural Nylon
Valance Panel to Rear
Bumper Bar Grommets

100 Pcs.

Metropolitan Supply

1227PK

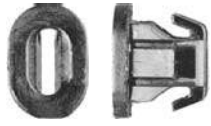

#6 (3.5mm) Screw Size
Hole Size: 6.5mm x 9mm
Stem Length: 8.5mm
Black Nylon
Front Fender Grille Nuts

50 Pcs.

1577PK



#8 (4.2mm) Screw Size
Hole Size: 6mm
Stem Length: 6.5mm
Natural Nylon
Side Marker Light Nuts

50 Pcs.

10556PK



#8 (4.2mm) Screw Size
Hole Size: 6.7mm
Stem Length: 11mm
Natural Nylon
Door Reveal Screw Grommets

25 Pcs.

9113PK



#8 (4.2mm) Screw Size
Hole Size: 7mm
Stem Length: 9mm
Natural Nylon
Radiator Grille Nuts

100 Pcs.

2940PK



#8 (4.2mm) Screw Size
Hole Size: 5/16"
Stem Length: 17/64"
Natural Nylon
Headlamp Bezel Nuts

50 Pcs.

1997PK



#8 (4.2mm) Screw Size
Hole Size: 7.5mm
Stem Length: 8mm
Black Nylon
Tail Light Grommets

25 Pcs.

Metropolitan Supply

1842PK



#8 (4.2mm) Screw Size
Hole Size: 1/4"
Stem Length: 13/32"
Natural Nylon
Grille Screw Nuts

50 Pcs.

10497PK



#8 (4.2mm) Screw Size
Hole Size: 5.5mm
Stem Length: 12mm
Natural Nylon
Rear Bumper Screw Grommets

50 Pcs.

1574PK

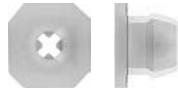

#8 (4.2mm) Screw Size
Hole Size: 5/16"
Stem Length: 9/32"
Natural Nylon
Grille Screw Nuts

100 Pcs.

2980PK

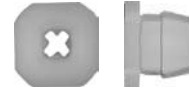

#8 (4.2mm) Screw Size
Hole Size: 5/16"
Stem Length: 9/32"
Natural Nylon
Grille Screw Nuts

50 Pcs.

9050PK

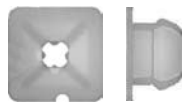

#8 (4.2mm) Screw Size
Hole Size: 11/32"
Stem Length: 17/64"
Natural Nylon
Grille Screw Nuts
50 Pcs.

10553PK



#8 (4.2mm) Screw Size
Hole Size: 1/2" x 15/32"
Black Nylon
Door Panel & Fender Shield
Screw Grommets

25 Pcs.

Metropolitan Supply

10783PK

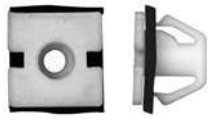

#8 (4.2mm) Screw Size
Hole Size: 8mm x 12mm
Head: 14mm Stem: 10mm
White Nylon With Sealer
Body Side Moulding Clips

15 Pcs.

10548PK

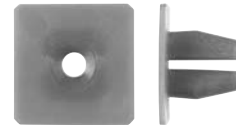

#8 (4.2mm) Screw Size
Hole Size: 9mm
Stem Length: 10mm
Natural Nylon
Door Trim Panel Nuts

25 Pcs.

10668PK

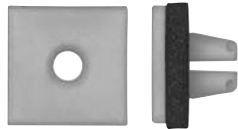

#8 (4.2mm) Screw Size
Hole Size: 9mm
Stem Length: 3/8"
Tan Nylon With Sealer
Tail Light Nuts

15 Pcs.

10922PK



#8 (4.2mm) Screw Size
Hole Size: 9.5mm x 12mm
Stem Length: 10mm
Marroon Nylon
Scuff Plate Screw Grommets

15 Pcs.

10636PK



#8 (4.2mm) Screw Size
Hole: 9mm Stem: 10mm
Natural Nylon
Bumper, Fender & Light
Screw Grommets

25 Pcs.

1572PK



#8 (4.2mm) Screw Size
Hole Size: 8mm
Stem Length: 17mm
Natural Nylon
Screw Grommets

25 Pcs.

Metropolitan Supply

10938PK

NEW!

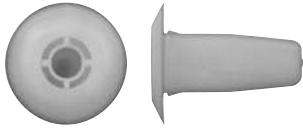

#8 (4.2mm) Screw Size
Hole Size: 8.5mm
Stem Length: 18.5mm
Natural Nylon
Screw Grommets

25 Pcs.

10926PK

NEW!

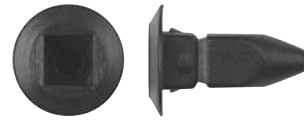

#8 (4.2mm) Screw Size
Hole Size: 9mm Stem: 20mm
Black Nylon
Bumper & Fender
Screw Grommets

15 Pcs.

10524PK



#8 (4.2mm) Screw Size
Hole Size: 8.5mm
Stem Length: 20mm
Natural Nylon With Sealer
Door Trim Panel Grommets

25 Pcs.

10552PK

NEW!



#8 (4.2mm) Screw Size
Hole Size: 6mm x 16.5mm
Natural Nylon With Sealer
Back Glass Mldg. & Interior Trim
Screw Grommets

15 Pcs.

10779PK

NEW!



#8 (4.2mm) Screw Size
Head Dia.: 17mm x 25mm
Stem Length: 14mm
White Nylon With Sealer
Fender & Rocker Moulding Clips

25 Pcs.

10772PK

NEW!



8mm x 10mm Hole Size
Head Dia.: 17mm x 25mm
Stem Length: 16mm
Yellow Nylon With Sealer
Exterior Trim Grommets

25 Pcs.

Metropolitan Supply

10498PK



8.5mm x 15.5mm Hole Size
Head Size: 13mm x 20mm
Stem Length: 17.5mm
Blue Nylon With Sealer
Headlight Grommets

10 Pcs.

10554PK



9mm x 16mm Hole Size
Head Size: 13mm x 20mm
Stem Length: 17mm
Black Nylon With Sealer
Rear Light Housing Grommets

15 Pcs.

1614PK



#10 (4.8mm) Screw Size
Hole Size: 8.5mm
Stem Length: 8mm
Natural Nylon
Screw Grommets

25 Pcs.

1610PK



#10 (4.8mm) Screw Size
Hole Size: 9mm
Stem Length: 7mm
Black Nylon
Screw Grommets

25 Pcs.

10794PK



5.5mm Screw Size
Hole Size: 9mm x 11mm
Stem Length: 10mm
White Nylon
Front Bumper Nuts

25 Pcs.

10777PK



#10 (4.8mm) Screw Size
Hole Size: 8.5mm
Stem Length: 10mm
Black Nylon
Fender Apron Nuts

25 Pcs.

Metropolitan Supply

10659PK



#10 (4.8mm) Screw Size
Hole Size: 9mm
Stem Length: 10mm
Natural Nylon
Screw Grommets

25 Pcs.

1296PK



#10 (4.8mm) Screw Size
Hole Size: 8mm x 8.5mm
Stem Length: 8mm
Natural Nylon
Screw Grommets

25 Pcs.

1560PK



#10 (4.8mm) Screw Size
Hole Size: 8mm x 9mm
Stem Length: 11mm
Natural Nylon
Headlamp Bezel & Grille Nuts

50 Pcs.

10796PK



#10 (4.8mm) Screw Size
Hole: 9mm Stem: 11mm
White Nylon
Front & Rear Bumper
Fender Nuts

25 Pcs.

10620PK

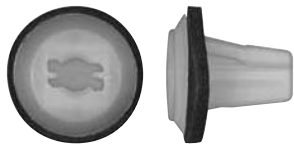

#10 (4.8mm) Screw Size
Hole: 8.5mm Stem: 13mm
Natural Nylon With Sealer
Body Side Floor & Trunk
Moulding Screw Grommets

15 Pcs.

1576PK



#10 Screw Size
Hole Size: 8.5mm
Stem Length: 17mm
Natural Nylon
Screw Grommets

25 Pcs.

Metropolitan Supply

10549PK

NEW!

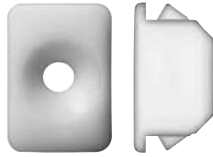

#10 (4.8mm) Screw Size
Head Size: 14mm x 20mm
Stem Length: 9.5mm
White Nylon
Cowl Vent Grommets

50 Pcs.

10942PK

NEW!

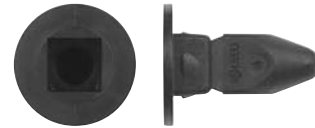

#10 (4.8mm) Screw Size
Hole Size: 8mm
Stem Length: 20mm
Black Nylon
Door Panel Screw Grommets

15 Pcs

10426PK

NEW!

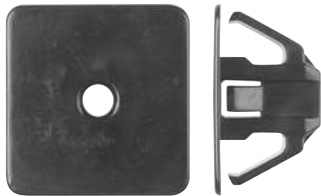

#10 (4.8mm) Screw Size
Hole: 9.5mm x 23mm Stem: 14mm
Black Nylon
Headlight To Grille
Spacer Bracket Grommets

10 Pcs.

9912PK

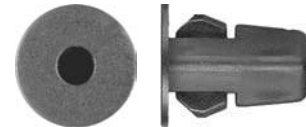

#12 (5.5mm) Screw Size
Hole: 9mm Stem: 19mm
Black Nylon
Front & Rear Wheel
Fender Liner Screw Grommets

15 Pcs.

9913PK

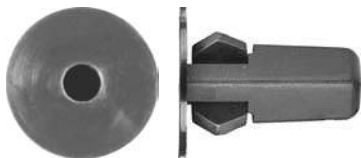

#12 (5.5mm) Screw Size
Hole: 8mm Stem: 22mm
Black Nylon
Front & Rear Wheel
Fender Liner Screw Grommets

15 Pcs.

10551PK

NEW!



#12 (5.5mm) Screw Size
Hole Size: 9mm x 12.5mm
Stem Length: 14mm
Natural Nylon
Door Handle Screw Grommets

15 Pcs.

Metropolitan Supply

10775PK



#12 (5.5mm) Screw Size
Hole Size: 9mm
Head: 13mm Stem: 8.5mm
White Nylon
Rocker Moulding Clips

25 Pcs.

10771PK



6mm Screw Size
Hole Size: 8.5mm
Stem Length: 8mm
Black Nylon
Headlight Component Nuts

15 Pcs.

10715PK

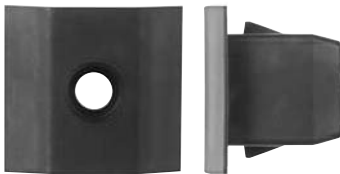

6mm Screw Size
Hole Size: 15mm
Stem Length: 16mm
Black Nylon
Headlight Component Nuts

15 Pcs.

10525PK

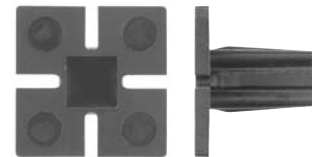

#14 (6.3mm) Screw Size
Hole Size: 8mm
Stem Length: 14mm
Black Nylon
License Plate Grommets

50 Pcs.

9872PK



#14 (6.3mm) Screw Size
Hole Size: 8.5mm
Stem Length: 8mm
Natural Nylon
License Plate Nuts

50 Pcs.

9101PK



#14 (6.3mm) Screw Size
Hole Size: 8.5 x 10.5mm
Stem Length: 8mm
Natural Nylon
Screw Grommets

50 Pcs.

Metropolitan Supply

10461PK



#14 (6.3mm) Screw Size
Hole Size: 9.5mm x 10mm
Stem Length: 8mm
Black Nylon With Sealer
License Plate Nuts

15 Pcs.

9494PK

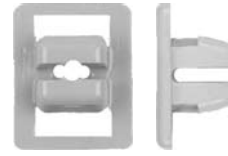

#14 (6.3mm) Screw Size
Hole Size: 3/8"
Stem Length: 5/16"
Natural Nylon
License Plate Nuts

50 Pcs.

1228PK

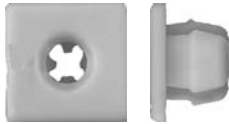

#14 (6.3mm) Screw Size
Hole Size: 13/32"
Stem Length: 5/16"
White Plastic
License Plate Nuts

50 Pcs.

1605PK

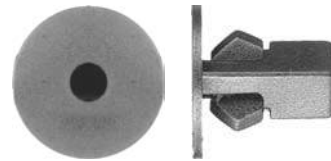

#14 (6.3mm) Screw Size
Hole Size: 8mm
Head: 20mm Stem: 17mm
Black Nylon
Screw Grommets

25 Pcs.

10745PK



5.5mm - 6mm Screw Size
Head Dia.: 17mm x 30mm
Stem Length: 9mm
Black Nylon
Front Bumper Screw Grommets

5 Pcs.

10918PK



7mm Hole Size
Stem Length: 11mm
Black Nylon
Inter Fender Nuts

25 Pcs.

Metropolitan Supply

10617PK

NEW!

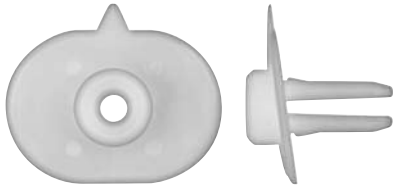

7.5mm x 12mm Hole Size
Stem Length: 14mm
Natural Nylon
Bumper Grommets

25 Pcs.

10943PK

NEW!



8mm Hole Size
Stem Length: 18mm
Black Nylon
Interior Frame Nuts

25 Pcs.

9355PK



10mm Hole Size
Stem Length: 9mm
Black Nylon
Grille & Side Marker Light
Grommets

50 Pcs.

10781PK

NEW!



10mm Hole Size
Head Size: 15mm
Stem Length: 8mm
Natural Nylon
Headlight Assembly Grommets

25 Pcs.

10526PK

NEW!



11mm Hole Size
Head Size: 15mm
Stem Length: 17mm
Black Nylon
Tail Light Grommets

5 Pcs.

9712PK

NEW!



11mm Hole Size
Head Size: 13mm
Stem Length: 9mm
White Nylon
Park & Turn Signal Grommets

50 Pcs.

Metropolitan Supply

9418PK

NEW!



11.5mm x 15.5mm Hole Size
Width: 22mm Length: 26mm
Black Nylon
Grille Grommet Retainers

10 Pcs.

10550PK

NEW!

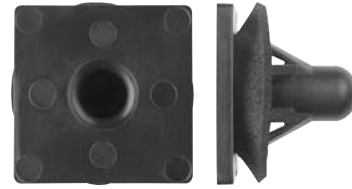

15mm Hole Size
Head Size: 24mm
Black Nylon With Sealer
Rear Light Housing
Screw Grommets

15 Pcs.

10541PK

NEW!



Receives 10mm Ball Stud
Hole Size: 14mm x 26mm
Black Nylon
Tail Light Grommets

25 Pcs.

10971PK

NEW!



Overall Height: 17mm
Overall Length: 30mm
Black Nylon
Bumper Filler Clips

10 Pcs.

9221PK



13/16" O.D.
Polished Stainless Steel
With Felt Insert
Door Lock Rod Ferrule

25 Pcs.

10244PK



1/4-20 Screw Size
Zinc Finish
Air Cleaner Hold Down
Wing Nuts

10 Pcs.

Metropolitan Supply

10245PK

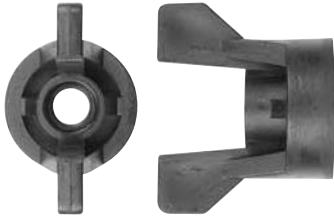

1/4-20 Screw Size
Black Nylon
Air Cleaner Hold Down
Wing Nuts

10 Pcs.

10242PK

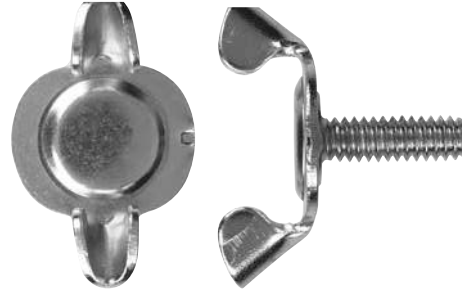

1/4-20 x 1" Screw Size
Zinc Finish
Air Cleaner Hold Down
Wing Nuts

10 Pcs.

10243PK

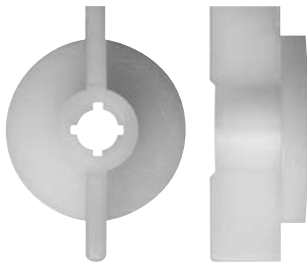

For 1/4" or 6mm Screw Size
Natural Nylon
Air Cleaner Hold Down
Wing Nuts

10 Pcs.

10240PK



6-1.00mm Screw Size
Yellow Zinc Finish
Air Cleaner Hold Down
Wing Nuts

10 Pcs.

10241PK



8-1.25mm Screw Size
Zinc Finish
Air Cleaner Hold Down
Wing Nuts

10 Pcs.

9709PK



5/16-18 Thread Size
Plain Finish
Slab Weld Nuts
25 Pcs.

Metropolitan Supply

10210PK



**5-.80mm Thread Size
Grip Range: 3.3mm - 5mm
Flange Size: 10mm
Hex Size: 7mm (9/32")
Hex Type Nut Inserts**

10 Pcs.

10211PK



**6-1.00mm Thread Size
Grip Range: 4.2mm - 7mm
Flange Size: 13mm
Hex Size: 9.5mm (3/8")
Hex Type Nut Inserts**

15 Pcs.

The image features a variety of black plastic fasteners and retainers, including screws with different head shapes (hex, Torx, Phillips), bolts, and specialized clips. Some have serrated threads, while others have smooth or knurled surfaces. The items are scattered across the white background, with some appearing as faint, semi-transparent overlays behind the main text.

Shield Retainers

Metropolitan Supply

JL-24PK



7/64" (2.5mm) Hole Size
Panel Range: .069" - .250"
Head: 7/32" Stem: 25/64"
Black Nylon
Shield Retainers

100 Pcs.

9863PK



1/8" (3.2mm) Hole Size
Head Diameter: 3/8"
Stem Length: 13/32"
Black Nylon
Weatherstrip Retainers

100 Pcs.

5602PK



5/32" (4mm) Hole Size
Panel Range: .030" - .275"
Head: 23/64" Stem: 7/16"
Black Nylon
Shield Retainers

100 Pcs.

5605PK



3/16" (4.5mm) Hole Size
Panel Range: .080" - .200"
Head: 7/16" Stem: 21/64"
Black Nylon
Weatherstrip Retainers

25 Pcs.

JL-32PK



3/16" (4.5mm) Hole Size
Panel Range: .125" - .310"
Head: 3/8" Stem: 17/32"
Black Nylon
Weatherstrip Retainers

25 Pcs.

9178PK



3/16" (4.5mm) Hole Size
Head Diameter: 7/16"
Stem Length: 1/2"
Black Nylon
Facia Shield Retainers

25 Pcs.

Metropolitan Supply

8172PK



3/16" (4.5mm) Hole Size
Panel Range: .060" - .390"
Head: 7/16" Stem: 21/32"
Black Nylon
Dash Panel Retainers

50 pcs.

10652PK



3/16" (4.8mm) Hole Size
Head Diameter: 9.4mm
Stem Length: 16mm
Black Nylon
Cowl & Dash Panel Retainers

50 Pcs.

9857PK



3/16" (5mm) Hole Size
Panel Range: .100" - .390"
Head: 13mm Stem: 16mm
Black Nylon
Shield Retainers

25 Pcs.

9528PK



3/16" (5mm) Hole Size
Head Diameter: 11mm
Stem Length: 17.8mm
Black Nylon
Rear Bumper Fascia Retainers

25 Pcs.

2034PK



3/16" (5mm) Hole Size
Head Diameter: 20mm
Stem Length: 15mm
Black Nylon
Trim Panel Retainers

25 Pcs.

1583PK

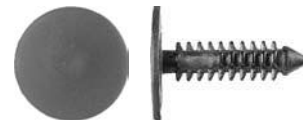

3/16" (5mm) Hole Size
Head: 19/32" Stem: 3/4"
Black Nylon
Screen Shroud Vent
Grille To Panel Retainers

50 Pcs.

Metropolitan Supply

JL-23PK



13/64" (5.3mm) Hole Size
Panel Range: .030" - .285"
Head: 10mm Stem: 11.5mm
Black Nylon
Weatherstrip Retainers

50 Pcs.

5609PK



13/64" (5.3mm) Hole Size
Panel Range: .030" - .365"
Head: 19/32" Stem: 5/8"
Black Nylon
Weatherstrip Retainers

50 Pcs.

JL-26PK

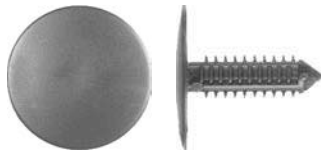

13/64" (5.3mm) Hole Size
Panel Range: .065" - .515"
Head: 3/4" Stem: 11/16"
Blue Nylon
Shield Retainers

50 Pcs.

10934PK



13/64" (5.5mm) Hole Size
Head Diameter: 14mm
Stem Length: 16mm
Black Nylon
Shield Retainers

50 Pcs.

5610PK



7/32" (5.5mm) Hole Size
Panel Range: .060" - .565"
Head: 21/32" Stem: 3/4"
Black Nylon
Shield Retainers

50 Pcs.

5614PK

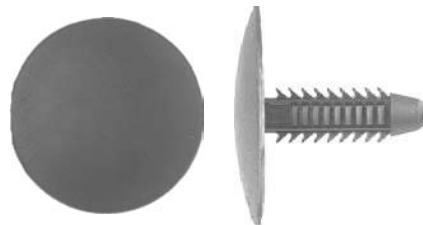

7/32" (5.5mm) Hole Size
Panel Range: .080" - .545"
Head: 1" Stem: 25/32"
Black Nylon
Shield Retainers

50 Pcs.

Metropolitan Supply

10676PK

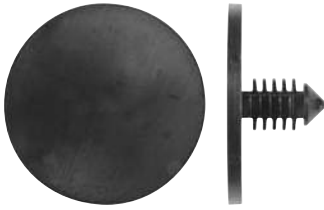

15/64" (6mm) Hole Size
Head Diameter: 26.6mm
Stem Length: 11mm
Black Nylon
Headliner Retainers

25 Pcs.

5618PK

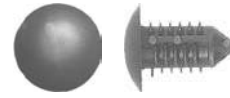

15/64" (6mm) Hole Size
Panel Range: .035" - .285"
Head: 15/32" Stem: 1/2"
Black Nylon
Shield Retainers

50 Pcs.

9446NPK



15/64" (6mm) Hole Size
Head Diameter: 1/2"
Stem Length: 15/16"
Natural Nylon
Shield Retainers
25 Pcs.

10568PK

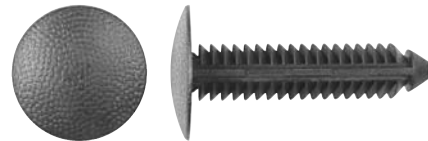

15/64" (6mm) Hole Size
Head Diameter: 18mm
Stem Length: 33mm
Black Nylon
Wheel Well Shield Retainers

25 Pcs.

9414PK



1/4" (6.3mm) Hole Size
Panel Range: 2.25mm - 4.75mm
Head: 18mm Stem: 15.2mm
Black Nylon
Front Fender Retainers

50 Pcs.

10391PK

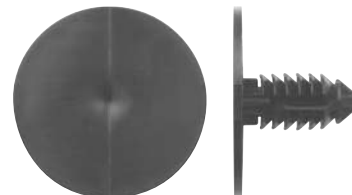

1/4" (6.3mm) Hole Size
Head Diameter: 25.4mm
Stem Length: 16mm
Black Nylon
Hood Insulation Retainers

50 Pcs.

Metropolitan Supply

10064PK

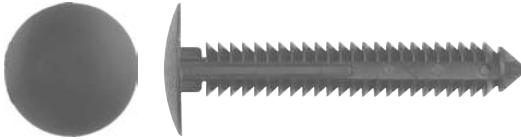

1/4" (6.3mm) Hole Size
Head Diameter: 18mm
Stem Length: 45mm
Black Nylon
Mud Flap Retainers

25 Pcs.

1410PK

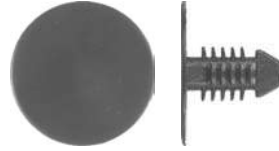

1/4" (6.4mm) Hole Size
Head Diameter: 3/4"
Stem Length: 1/2"
Black Nylon
Mud Shield Retainers

100 Pcs.

9500PK



1/4" (6.4mm) Hole Size
Panel Range: .070" - .450"
Head: 1/2" Stem: 11/16"
Black Nylon
Window Moulding Retainers

25 Pcs.

1761PK



1/4" (6.4mm) Hole Size
Panel Range: .115" - .400"
Head: 11/16" Stem: 21/32"
Gray Nylon
Shield Retainers

50 Pcs.

5429PK



1/4" (6.4mm) Hole Size
Panel Range: .115" - .400"
Head: 11/16" Stem: 21/32"
Black Nylon
Shield Retainers

100 Pcs.

5506PK



1/4" (6.4mm) Hole Size
Panel Range: .110" - .460"
Head: 1/2" Stem: 23/32"
Black Nylon
Trim Panel Retainers

50 Pcs.

Metropolitan Supply

5625PK



1/4" (6.4mm) Hole Size
Panel Range: .095" - .540"
Head: 23/32" Stem: 13/16"
Black Nylon
Shield Retainers

100 Pcs.

5625WPK

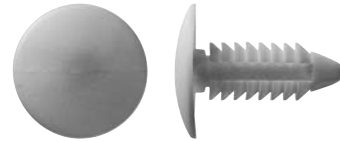

1/4" (6.4mm) Hole Size
Panel Range: .095" - .540"
Head: 23/32" Stem: 13/16"
Appliance White Nylon
Shield Retainers
25 Pcs.

5625CWPk

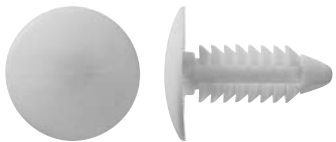

1/4" (6.4mm) Hole Size
Panel Range: .095" - .540"
Head: 23/32" Stem: 13/16"
Creamy White Nylon
Shield Retainers
25 Pcs.

5625GYPK

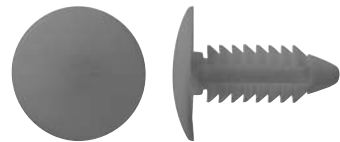

1/4" (6.4mm) Hole Size
Panel Range: .095" - .540"
Head: 23/32" Stem: 13/16"
Grey Nylon
Shield Retainers
25 Pcs.

5625CPK

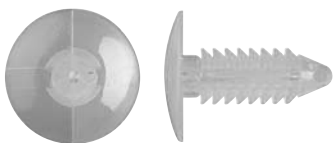

1/4" (6.4mm) Hole Size
Panel Range: .095" - .540"
Head: 23/32" Stem: 13/16"
Clear Nylon
Shield Retainers
25 Pcs.

5625NPK

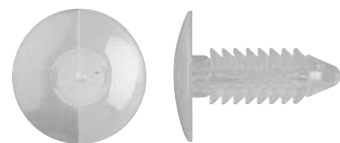

1/4" (6.4mm) Hole Size
Panel Range: .095" - .540"
Head: 23/32" Stem: 13/16"
Natural Nylon
Shield Retainers
25 Pcs.

Metropolitan Supply

5632PK

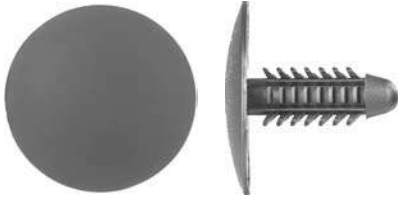

1/4" (6.4mm) Hole Size
Panel Range: .070" - .590"
Head: 25.5mm Stem: 20mm
Black Nylon
Fascia Panel Retainers

50 Pcs.

9446PK



1/4" (6.4mm) Hole Size
Head: 1/2" Stem: 15/16"
Black Nylon
Engine Mount Heat
Retainers

25 Pcs.

9130PK



1/4" (6.4mm) Hole Size
Panel Range: .095" - .805"
Head: 23/32" Stem: 1 1/16"
Black Nylon
Shield Retainers

50 Pcs.

10366PK

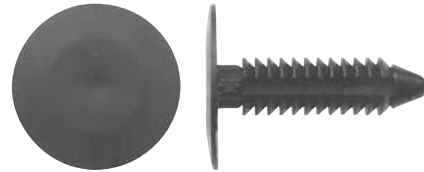

1/4" (6.4mm) Hole Size
Head: 7/8" Stem: 7/16"
Black Nylon
Splash Shield &
Wheel Cover Retainers

50 Pcs.

5628PK

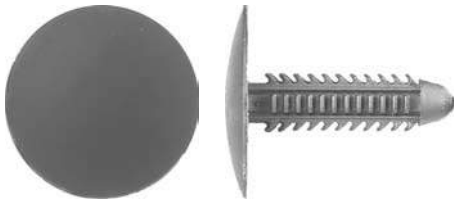

1/4" (6.4mm) Hole Size
Panel Range: .070" - .805"
Head: 1" Stem: 1 1/16"
Black Nylon
Shield Retainers

25 Pcs.

5627PK



1/4" (6.4mm) Hole Size
Panel Range: .100" - .685"
Head: 1" Stem: 1 3/32"
Black Nylon
Trim Panel Retainers

50 Pcs.

Metropolitan Supply

9345PK

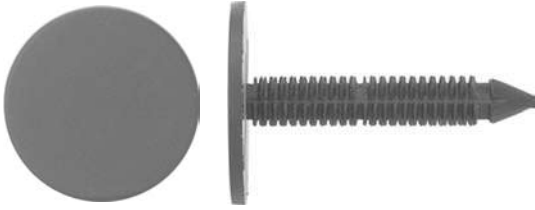

1/4" (6.4mm) Hole Size
Head Diameter: 1"
Stem Length: 1 7/16"
Black Nylon
Shield Retainers

25 Pcs.

10941PK

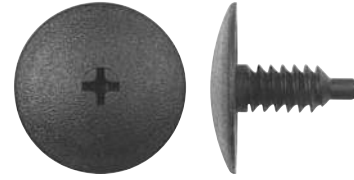

6.5-1.50 x 16mm Screw Size
Head: 23mm Stem: 18mm
Phillips Drive Textured Head
Black Nylon
Cowl Vent Screws

25 Pcs.

10462PK

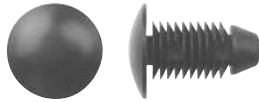

17/64" (7mm) Hole Size
Panel Range: .8mm - 8mm
Head: 12.6mm Stem: 15.5mm
Black Nylon
Weatherstrip Retainers

50 Pcs.

9485PK

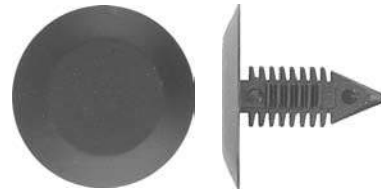

17/64" (7mm) Hole Size
Head Diameter: 15/16"
Stem Length: 3/4"
Black Nylon
Door Trim Panel Retainers

25 Pcs.

1644PK



17/64" (7mm) Hole Size
Head: 15/16" Stem: 3/4"
Natural Nylon
Interior Trim
Panel Retainers

50 Pcs.

9374PK



17/64" (7mm) Hole Size
Head: 25/32" Stem: 15/64"
Black Nylon
Shield Retainers

25 Pcs.

Metropolitan Supply

1149PK

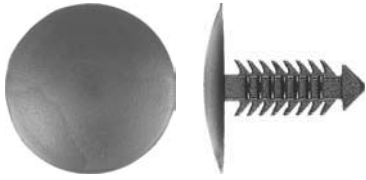

17/64" (7mm) Hole Size
Panel Range: 2.5mm - 13.5mm
Head: 25mm Stem: 20.5mm
Black Nylon
Door Frame Spacer Retainers

25 Pcs.

9376PK



17/64" (7mm) Hole Size
Head Diameter: 10mm
Stem Length: 33.5mm
Black Nylon
Bumper Cover Retainers

25 Pcs.

5635PK

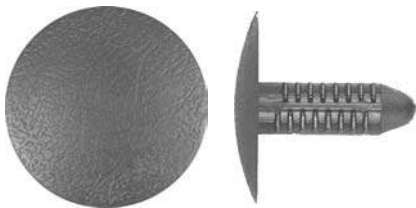

9/32" (7.1mm) Hole Size
Panel Range: 2.56mm - 12.96mm
Head : 25mm Stem: 20mm
Black Nylon
Interior Trim Retainers

50 Pcs.

9849PK

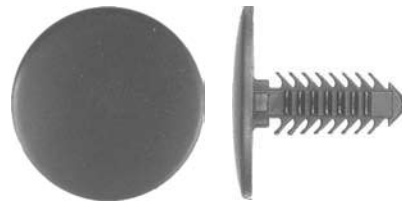

9/32" (7.1mm) Hole Size
Panel Range: .106 - .540"
Head: 1" Stem: 27/32"
Black Nylon
Fascia Panel Retainers

25 Pcs.

9132PK

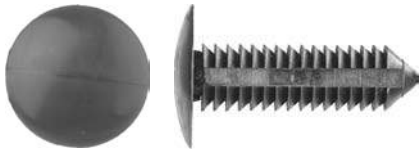

9/32" (7.1mm) Hole Size
Panel Range: .055" - 1.005"
Head: 3/4" Stem: 1 11/64"
Black Nylon
Bumper Fascia Retainers

25 Pcs.

2048PK

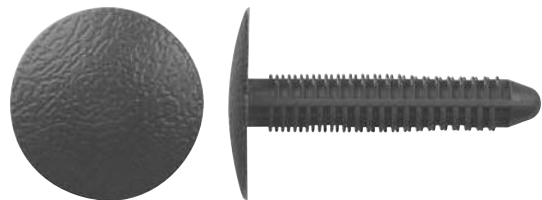

9/32" (7.1mm) Hole Size
Panel Range: .075" - 1.25"
Head: 26mm Stem: 38.5mm
Black Nylon
Interior Trim Retainers

25 Pcs.

Metropolitan Supply

JL-120PK

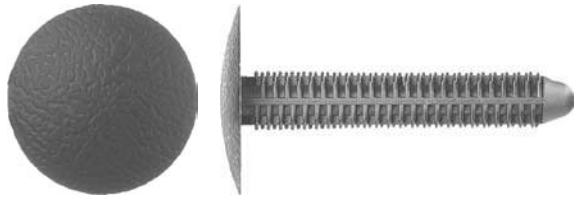

9/32" (7.1mm) Hole Size
Panel Range: .075" - 1.510"
Head: 1" Stem: 1 3/4"
Black Nylon
Trim Panel Retainers

25 Pcs.

10517PK

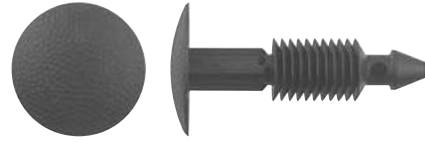

9/32" (7.5mm) Hole Size
Head Diameter: 18mm
Stem Length: 32mm
Black Nylon
Cowl Vent Retainers

25 Pcs.

10557PK

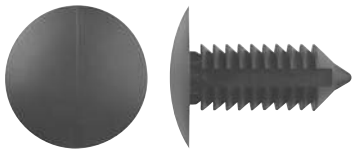

9/32" (7.14mm) Hole Size
Panel Range: .088" - .650"
Head: 3/4" Stem: 7/8"
Black Nylon
Trim Panel Retainers

50 Pcs.

10611PK

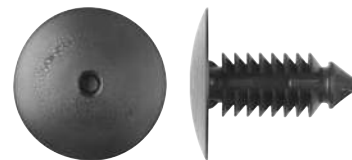

9/32" (7.25mm) Hole Size
Head Diameter: 20mm
Stem Length: 21mm
Black Nylon
Shield Retainers

25 Pcs.

5640PK

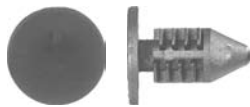

5/16" (7.8mm) Hole Size
Panel Range: .080" - .270"
Head: 33/64" Stem: 19/32"
Black Nylon
Panel Retainers

25 Pcs.

9520PK



5/16" (7.8mm) Hole Size
Head Diameter: 5/8"
Stem Length: 21/32"
Black Nylon
Hood Seal Retainers

25 Pcs.

Metropolitan Supply

10675PK

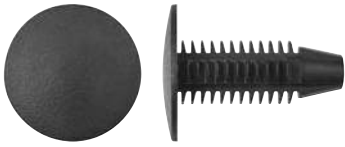

19/64" (7.6mm) Hole Size
Head Diameter: 18mm
Stem Length: 22mm
Black Nylon
Radiator Side Shield Retainers

25 Pcs.

JL-33PK

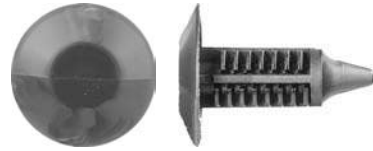

5/16" (7.8mm) Hole Size
Panel Range: .078" - .490"
Head: 3/4" Stem: 31/32"
Black Nylon
Trim Panel Retainers

25 Pcs.

8862BPK

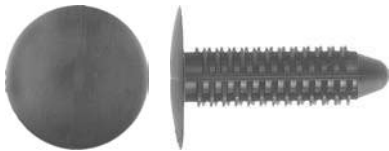

5/16" (7.8mm) Hole Size
Panel Range: .080" - .800"
Head: 3/4" Stem: 1 1/16"
Black Nylon
Shield Retainers

25 pcs.

5995PK



5/16" (7.8mm) Hole Size
Panel Range: .060" - 1.025"
Head: 3/4" Stem: 1 7/16"
Black Nylon
Hood Seal Retainers

25 Pcs.

5643PK

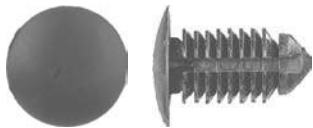

23/64" (9mm) Hole Size
Panel Range: .060" - .510"
Head: 16mm Stem: 19.5mm
Black Nylon
Trim Panel Retainers

50 Pcs.

10469PK

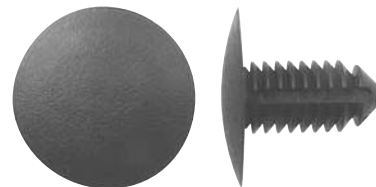

11/32" (9mm) Hole Size
Panel Range: 1.6mm - 10mm
Head: 24mm Stem: 20mm
Black Nylon
Front End Retainers

25 Pcs.

Metropolitan Supply

9352PK



3/8" (9.5mm) Hole Size
Head Diameter: 7/8"
Stem Length: 57/64"
Black Nylon
Front End Stone Shield Retainers

25 Pcs.

5710PK

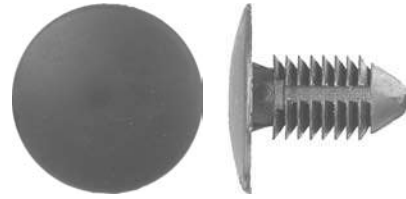

3/8" (9.5mm) Hole Size
Panel Range: .115" - .565"
Head: 1" Stem: 27/32"
Black Nylon
Panel Retainers

25 Pcs.

5648PK

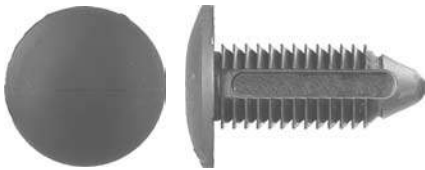

25/64" (10mm) Hole Size
Panel Range: .040" - .787"
Head: 22mm Stem: 30mm
Black Nylon
Fascia Bumper Retainers

50 Pcs.

9493PK



13/32" (10.4mm) Hole Size
Head Diameter: 25.5mm
Stem Length: 37.5mm
Black Nylon
Firewall Insulation Retainers

25 Pcs.

10672PK

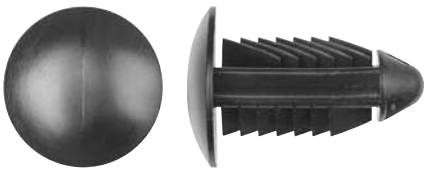

13/32" (10.5mm) Hole Size
Head Diameter: 21.5mm
Stem Length: 28mm
Black Nylon
Bumper Fascia Retainers

15 Pcs.

9763PK

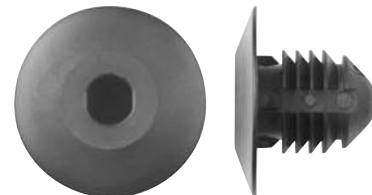

1/2" (12.5mm) Hole Size
Panel Range: 3.2mm - 5mm
Head: 25mm Stem: 15mm
Black Nylon
Bumper Fascia Retainers

25 Pcs.

Metropolitan Supply

10734PK

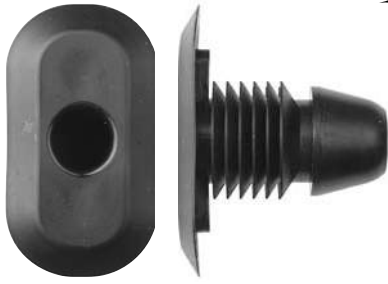

NEW!

5/8" (16mm) Slotted Hole
Head Diameter: 19.8mm x 36mm
Stem Length: 25mm
Black Nylon
Bumper Retainers

5 Pcs.

10539PK

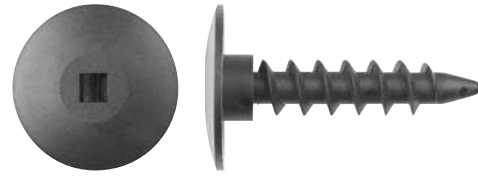

NEW!

7.5mm x 35mm
Square Drive Truss Head
Head: 22mm Stem: 34mm
Black Nylon
Bumper Fascia Screws

15 Pcs.

10665PK

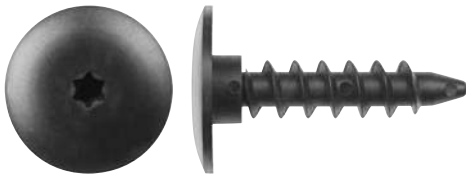

NEW!

T25 Torx Drive
Head Diameter: 22mm
Stem Length: 34mm
Black Nylon
Bumper Cover Retainers

25 Pcs.

10566PK

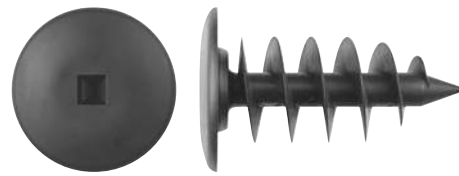

NEW!

12mm Hole Size
#3 Square Drive
Head: 22mm Stem: 34mm
Black Nylon
Bumper & Door Insulator Screws
25 Pcs.

9195PK

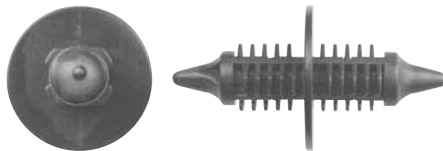

5/16" (7.9mm) Hole Size
Washer O.D.: 3/4"
O.A. Length: 1 7/16"
Black Nylon
Radiator Grille Retainers

25 Pcs.

10613PK

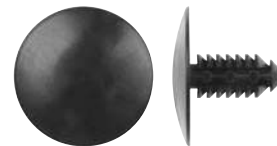

NEW!

4.75mm Hole Size
Head Diameter: 19mm
Stem Length: 12mm
Black Nylon
Hood Insulation Retainers

25 Pcs.

2025PK



3/16" (5mm) Hole Size
Head Diameter: 30mm
Stem Length: 9mm
Black Nylon
Hood Insulation Retainers

15 Pcs.

9522PK



15/64" (6mm) Hole Size
Head Diameter: 14mm
Stem Length: 10mm
Black Nylon
Hood Insulation Retainers

25 Pcs.

10379PK

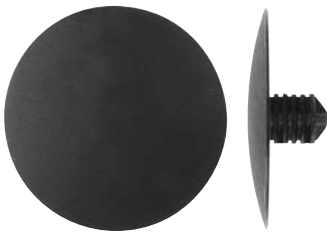

15/64" (6mm) Hole Size
Head Diameter: 30mm
Stem Length: 9mm
Black Nylon
Hood Insulation Retainers

15 Pcs.

9980PK

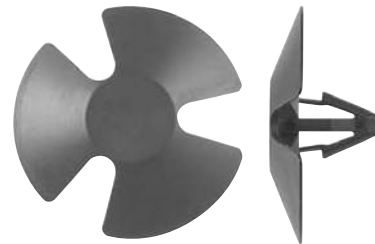

1/4" (6.3mm) Hole Size
Head Diameter: 30mm
Stem Length: 13mm
Black Nylon
Hood Insulation Retainer

50 Pcs.

2167PK

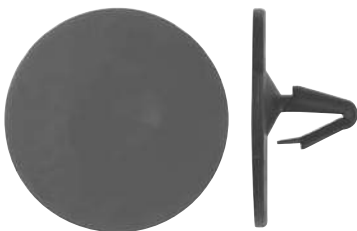

1/4" (6.3mm) Hole Size
Head Diameter: 30mm
Stem Length: 12.5mm
Black Nylon
Hood Insulation Retainers

50 Pcs.

969PK



1/4" (6.4mm) Hole Size
Head Dia.: 1/2" x 1 1/2"
Stem Length: 5/8"
Black Nylon
Hood Insulation Retainers

25 Pcs.

Metropolitan Supply

1865PK

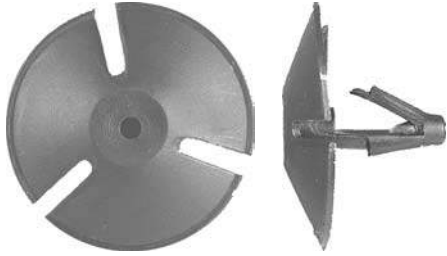

1/4" (6.4mm) Hole Size
Head Diameter: 1 5/16"
Stem Length: 13/16"
Black Nylon
Hood Insulation Retainers

25 Pcs.

2111PK

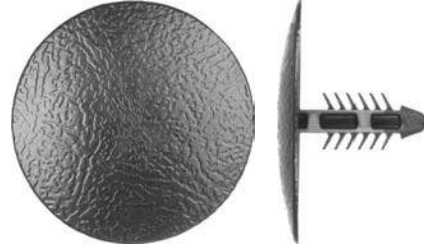

1/4" (6.3mm) Hole Size
Head Diameter: 32mm
Stem Length: 18mm
Black Nylon
Hood Insulation Retainers

50 Pcs.

9588PK

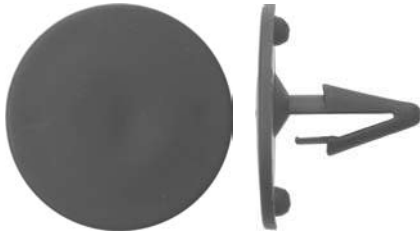

1/4" (6.4mm) Hole Size
Head Diameter: 1 3/16"
Stem Length: 3/4"
Black Nylon
Hood Insulation Retainers

50 Pcs.

1930PK



1/4" (6.4mm) Hole Size
Head: 1 5/8" Stem: 3/4"
Black Nylon
Hood Insulation Retainers

25 Pcs.

1573PK

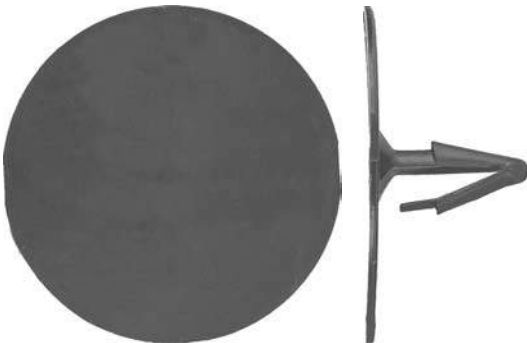

1/4" (6.4mm) Hole Size
Head: 1 3/4" Stem: 3/4"
Black Nylon
Hood Insulation Retainers

50 Pcs.

5440PK

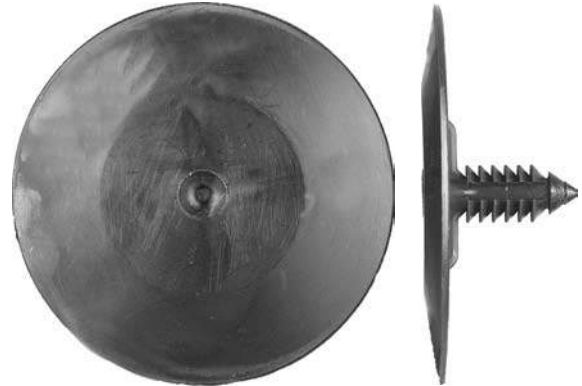

1/4" (6.4mm) Hole Size Head: 2"
Black Polypropylene
Hood Insulation Retainers

25 Pcs.

Metropolitan Supply

10670PK

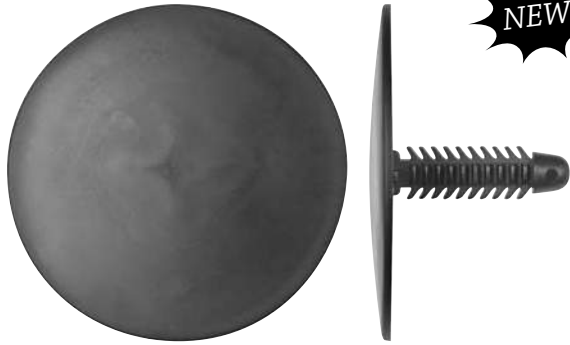

1/4" (6.4mm) Hole Size
Head: 1 3/4" Stem: 1"
Black Nylon
Trim Panel Retainers

25 Pcs.

9513PK

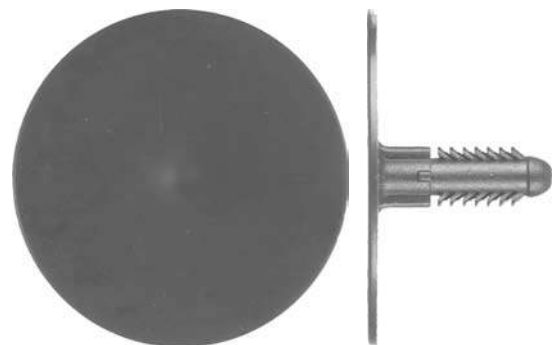

1/4" (6.4mm) Hole Size
Head: 1 3/4" Stem: 7/8"
Black Nylon
Hood Insulation Retainers

25 Pcs.

10141PK

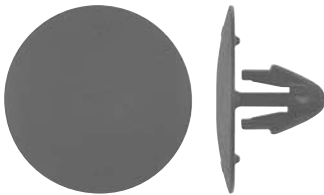

17/64" (7mm) Hole Size
Head Diameter: 25mm
Stem Length: 10mm
Black Nylon
Hood Insulation Retainers

15 Pcs.

9403PK



17/64" (7mm) Hole Size
Head Diameter: 25mm
Stem Length: 12mm
Black Nylon
Hood Insulation Retainers

15 Pcs.

1929PK

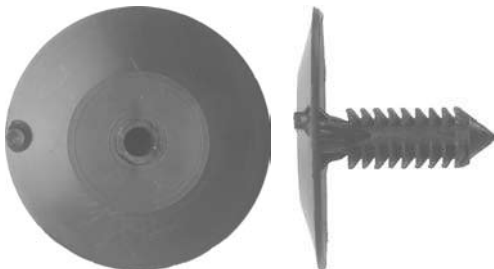

17/64" (7mm) Hole Size
Head: 35mm Stem: 25mm
Black Polypropylene
Hood Insulation Retainers

25 Pcs.

10435PK



17/64" (7mm) Hole Size
Head Diameter: 30mm
Stem Length: 14mm
Black Nylon
Hood Insulation Retainers

25 Pcs.

Metropolitan Supply

9328PK



17/64" (7mm) Hole Size
Head Diameter: 30mm
Stem Length: 17mm
Black Nylon
Hood Insulation Retainers

15 Pcs.

1950PK



17/64" (7mm) Hole Size
Head Diameter: 30mm
Stem Length: 17mm
Black Nylon
Retaining Retainers

25 Pcs.

10393PK

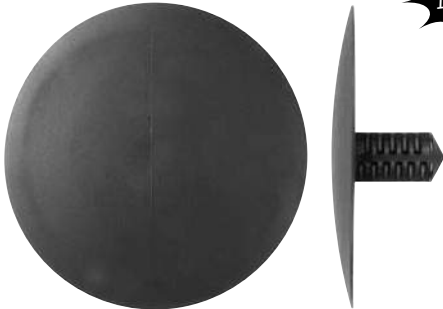

9/32" (7.1mm) Hole Size
Head: 40mm Stem: 13mm
Black Nylon
Hood Insulation Retainers

25 Pcs.

9945PK

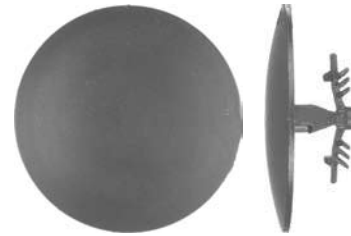

9/32" (7.5mm) Hole Size
Head Diameter: 30mm
Stem Length: 10mm
Black Nylon
Hood Insulation Retainers

15 Pcs.

10782PK

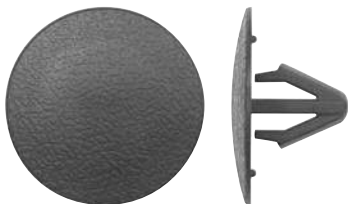

5/16" (8mm) Hole Size
Head Diameter: 26mm
Stem Length: 14mm
Black Nylon
Hood Insulation Retainers

15 Pcs.

10677PK

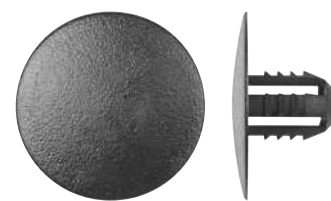

21/64" (8.5mm) Hole Size
Head Diameter: 25mm
Stem Length: 12.5mm
Black Nylon
Hood Insulation Retainers

25 Pcs.

10944PK

NEW!

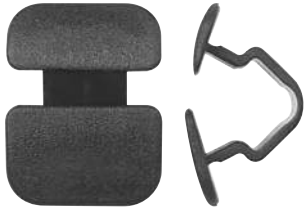

15/32" (12mm) Hole Size
Head Dia.: 20mm x 25mm
Stem Length: 13mm
Black Nylon
Hood Insulation Retainers

15 Pcs.

10953PK

NEW!



15/32" (12mm) Hole Size
Head Dia.: 30mm x 23mm
Stem Length: 13mm
Black Nylon
Hood Insulation Retainers

15 Pcs.

10662PK

NEW!



1/8" (3.3mm) Hole Size
Head Dia.: 6mm x 12mm
Stem Length: 9.6mm
Black Nylon
Weatherstrip Retainers

100 Pcs.

1991PK



3/16" (4.5mm) Hole Size
Head Dia.: 4.75mm x 13.5mm
Stem Length: 12mm
Black Nylon
Weatherstrip Retainers

100 Pcs.

9875PK



3/16" (4.5mm) Hole Size
Head Dia.: 5mm x 13mm
Stem Length: 16mm
Natural Nylon
Weatherstrip Retainers

50 Pcs.

10929PK

NEW!



3/16" (4.5mm) Hole Size
Head Dia.: 5mm x 13mm
Stem Length: 10mm
Black Nylon
Weatherstrip Retainers

25 Pcs.

Metropolitan Supply

10657PK

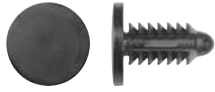

11/64" (4.2mm) Hole Size
Head Diameter: 11mm
Stem Length: 12mm
Black Nylon
Weatherstrip Retainers

50 Pcs.

10501PK

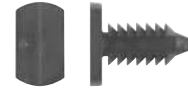

3/16" (4.8mm) Hole
Head Dia.: 6.5mm x 11mm
Stem Length: 12.2mm
Black Nylon
Weatherstrip Retainers

100 Pcs.

2016PK

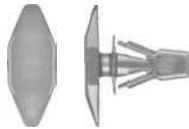

13/64" (5mm) Hole Size
Head Dia.: 6.5mm x 16.5mm
Stem Length: 10.5mm
White Nylon
Weatherstrip Retainers

50 Pcs.

10577PK

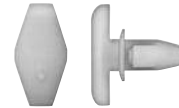

13/64" (5mm) Hole Size
Head Dia.: 7mm x 14mm
Stem Length: 10.5mm
Natural Nylon
Weatherstrip Retainers

50 Pcs.

10388PK

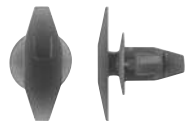

13/64" (5mm) Hole Size
Head Dia.: 5mm x 15mm
Stem Length: 10mm
Green Nylon
Weatherstrip Retainers

100 Pcs.

10521PK

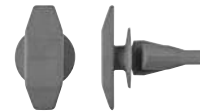

13/64" (5mm) Hole Size
Head Dia.: 5mm x 14mm
Stem Length: 10mm
Blue Nylon
Weatherstrip Retainers

100 Pcs.

Metropolitan Supply

10513PK

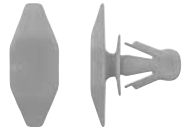

13/64" (5mm) Hole Size
Head Dia.: 6.5mm x 16.5mm
Stem Length: 8mm
White Nylon
Weatherstrip Retainers

100 Pcs.

9560PK

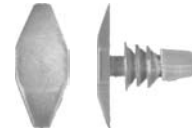

13/64" (5mm) Hole Size
Head Dia.: 7mm x 16mm
Stem Length: 10mm
Natural Nylon
Weatherstrip Retainers

50 Pcs.

10663PK

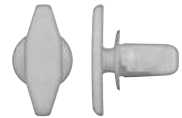

13/64" (5mm) Hole Size
Head Dia.: 5mm x 15mm
Stem Length: 7.8mm
Yellow Nylon
Weatherstrip Retainers

100 Pcs.

10664PK



13/64" (5mm) Hole Size
Top Head Dia.: 10.9mm
Stem Length: 10.5mm
Natural Nylon
Weatherstrip Retainers

50 Pcs.

10578PK



13/64" (5mm) Hole Size
Head Dia.: 5mm x 15mm
Stem Length: 13.10mm
Green Nylon
Weatherstrip Retainers

50 Pcs.

10661PK

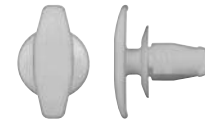

13/64" (5mm) Hole Size
Head Dia.: 5mm x 15mm
Yellow Nylon
Door & Hood Seal
Weatherstrip Retainers

100 Pcs.

10506PK

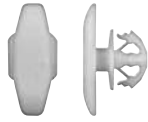

5.8mm Hole Size
Head Dia.: 5mm x 15mm
Stem Length: 7mm
Natural Nylon
Weatherstrip Retainers

100 Pcs.

9264PK



15/64" (6mm) Hole Size
Head Dia.: 5.25mm x 14.2mm
Stem Length: 12.3mm
Black Nylon
Weatherstrip Retainers

50 Pcs.

9208PK



15/64" (6mm) Hole Size
Head Dia.: 5mm x 15mm
Stem Length: 10mm
Orange Nylon
Weatherstrip Retainers

25 Pcs.

9336PK

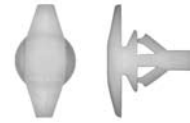

15/64" (6mm) Hole Size
Head Dia.: 5mm x 15mm
Stem Length: 10mm
Natural Nylon
Weatherstrip Retainers

10 Pcs.

10766PK

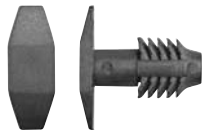

6.5mm Hole Size
Head Dia.: 6mm x 16mm
Stem Length: 14mm
Black Nylon
Hood Weatherstrip Retainers

50 Pcs.

10767PK

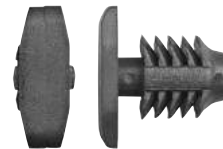

6.5mm Hole Size
Head Dia.: 4.6mm x 13mm
Stem Length: 11mm
Black Nylon
Hood W/Strip Moulding Clips

100 Pcs.

Metropolitan Supply

10567PK



6.8mm Hole Size
Head Diameter: 9mm
Stem Length: 14.5mm
Yellow Nylon
Weatherstrip Retainers

100 Pcs.

10660PK



5/16" (8mm) Hole Size
Head Diameter: 16mm
Stem Length: 9.3mm
Black Nylon
Weatherstrip Retainers

50 Pcs.

9074PK



13/64" (5mm) Hole Size
Panel Thickness: 3mm
Head: 14mm Stem: 10mm
Black Nylon
Panel Retainers

25 Pcs.

1996PK



13/64" (5mm) Hole Size
Head Diameter: 13mm
Stem Length: 11mm
Black Nylon
Retaining Clips

50 Pcs.

1466PK



13/64" (5mm) Hole Size
Head Diameter: 13mm
Stem Length: 15mm
Black Nylon
Retaining Clips

25 Pcs.

9554PK



13/64" (5mm) Hole Size
Panel Thickness: 4mm
Head: 13mm Stem: 15mm
Black Nylon
Retaining Clips

50 Pcs.

Metropolitan Supply

10415PK



13/64" (5mm) Hole Size
Head Diameter: 16mm
Stem Length: 15mm
Black Nylon
Retaining Clips

25 Pcs.

10411PK



15/64" (6mm) Hole Size
Head Diameter: 14mm
Stem Length: 11mm
Black Nylon
Retaining Clips

25 Pcs.

9886PK



7/32" (5.5mm) Hole Size
Panel Range: 5mm
Head: 11mm Stem: 15mm
Black Nylon
Retaining Clips

50 Pcs.

5606PK



15/64" (6mm) Hole Size
Panel Range: 4mm
Head: 10mm Stem: 10mm
Black Nylon
Hood Moulding Retainers

25 Pcs.

9262PK



15/64" (6mm) Hole Size
Panel Range: 9mm
Head: 12mm Stem: 9mm
Black Nylon
Hood & Trunk Moulding Retainers

10 Pcs.

1634PK



15/64" (6mm) Hole Size
Panel Range: 5mm
Head: 14mm Stem: 16mm
Black Nylon
Retaining Clips

50 Pcs.

Metropolitan Supply

2002PK



15/64" (6mm) Hole Size
Head Diameter: 14mm
Stem Length: 15mm
Black Nylon
Cowl Top Retaining Clips

15 Pcs.

9977PK



1/4" (6mm) Hole Size
Head Diameter: 16mm
Stem Length: 21mm
Black Nylon
Bumper Retainers

15 Pcs.

10417PK

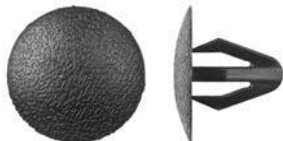

17/64" (7mm) Hole Size
Head Diameter: 18mm
Stem Length: 12mm
Black Nylon
Retaining Clips

50 Pcs.

10408PK



17/64" (7mm) Hole Size
Head Diameter: 18mm
Stem Length: 15mm
Black Nylon
Retaining Clips

25 Pcs.

1579PK

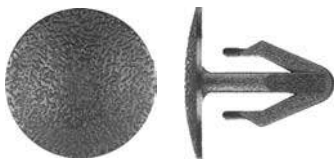

17/64" (7mm) Hole Size
Panel Range: 7mm
Head: 20mm Stem: 16mm
Black Nylon
Retaining Clips

50 Pcs.

10416PK



17/64" (7mm) Hole Size
Head Diameter: 15mm
Stem Length: 20mm
Black Nylon
Retaining Clips

25 Pcs.

Metropolitan Supply

9901PK

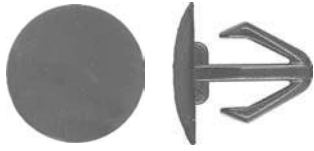

5/16" (8mm) Hole Size
Panel Range: 5mm
Head: 18mm Stem: 15mm
Black Nylon
Retaining Clips

25 Pcs.

10414PK



5/16" (8mm) Hole Size
Head Diameter: 15mm
Stem Length: 15mm
Black Nylon
Retaining Clips

25 Pcs.

10407PK

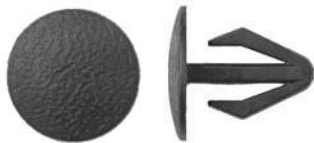

5/16" (8mm) Hole Size
Head Diameter: 18mm
Stem Length: 18mm
Black Nylon
Retaining Clips

25 Pcs.

9864PK

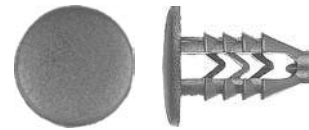

5/16" (8mm) Hole Size
Head Diameter: 16mm
Stem Length: 18mm
Black Nylon
Interior Trim Retainers

50 Pcs.

10412PK



25/64" (10mm) Hole Size
Head Diameter: 20mm
Stem Length: 20mm
Black Nylon
Retaining Clips

25 Pcs.

1310PK



13/64" (5mm) Hole Size
Head Diameter: 3/8"
Stem Length: 15/32"
Black Nylon
Tail Light Retainers

25 Pcs

Metropolitan Supply

9859PK



13/64" (5mm) Hole Size
Flange Diameter: 7mm
Stem Length: 10mm
Black Nylon Door Handle
Push Type Retainers

25 Pcs.

1756PK



15/64" (6mm) Square Hole Size
Flange Dia.: 8mm x 12mm
Stem Length: 8mm
Black Nylon
Cowl Grille Retainers

25 Pcs.

10656PK



15/64" (6mm) Hole Size
Flange Diameter: 12mm
Stem Length: 8mm
Black Nylon
Push Type Retainers

25 Pcs.

9617PK



15/64" (6mm) Hole Size
Flange: 17mm Stem: 16mm
Black Nylon
Radiator, Wheelhouse & Fender
Push Type Retainers

25 Pcs.

9320PK



15/64" (6mm) Hole Size
Flange Diameter: 15mm
Stem Length: 23mm
Black Nylon
Fascia Retainers

50 Pcs.

10797PK

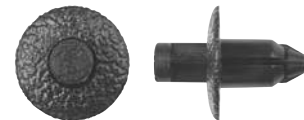

1/4" (6.3mm) Hole Size
Flange: 15mm Stem: 12mm
Black Nylon
Interior Trim, Bumper &
Grille Retainers

25 Pcs.

Metropolitan Supply

10655PK

NEW!



1/4" (6.3mm) Hole Size
Flange Diameter: 15mm
Stem Length: 13mm
Black Nylon
Push Type Retainers

10 Pcs.

10423PK

NEW!

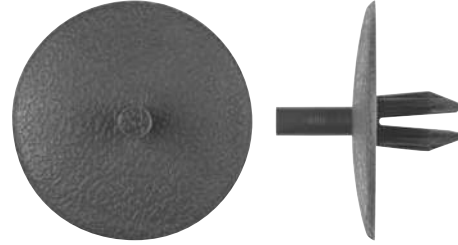

1/4" (6.3mm) Hole Size
Flange Diameter: 1 1/4"
Stem Length: 7/16"
Grey Nylon
Headliner Retainers

15 Pcs.

9046PK



1/4" (6.4mm) Hole Size
Textured Head
Black Nylon
Instrument Panel
Grille Retainers
15 Pcs.

9559PK



1/4" (6.4mm) Hole Size
Flange: 19/32" Stem: 3/4"
Black Nylon
Wheel Opening Moulding
Push Type Retainers

25 Pcs.

5675PK



1/4" (6.4mm) Hole Size
Panel Range: 9/16"
Flange: 11/16" Stem: 9/16"
Black Nylon
Mud Skirt Blind Rivets

50 Pcs.

2045PK



1/4" (6.4mm) Hole Size
Flange Diameter: 11/16"
Stem Length: 13/16"
Black Nylon
Push Type Retainers

25 Pcs.

Metropolitan Supply

9369PK



1/4" (6.4mm) Hole Size
Flange Diameter: 11/16"
Stem Length: 29/32"
Black Nylon
Exterior Body Retainers

25 Pcs.

1087PK



1/4" (6.4mm) Hole Size
Flange Diameter: 11/16"
Stem Length: 5/8"
Black Nylon
Push Type Retainers

50 Pcs.

9858PK

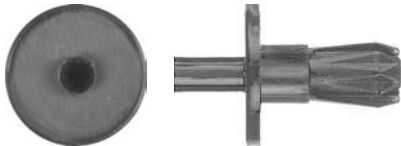

1/4" (6.4mm) Wide Slot
Flange Diameter: 3/4"
Stem Length: 11/16"
Black Nylon
Grille Retainers

50 Pcs.

9745PK



1/4" (6.4mm) Hole Size
Flange Diameter: 3/4"
Stem Length: 1 1/8"
Black Nylon
Push Type Retainers

25 Pcs.

5935PK

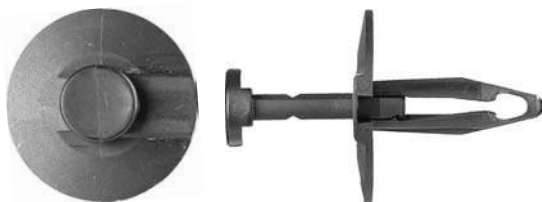

1/4" (6.4mm) Hole Size
Panel Range: .098" - .350"
Flange: 1" Stem: 29/32"
Black Nylon
Splash Shield Blind Rivets

25 Pcs.

10505PK



1/4" (6.4mm) Hole Size
Head Diameter: 7/8"
Stem Length: 1"
Black Nylon
Lower Sill Moulding Retainers

15 Pcs.

10368PK



17/64" (6.5mm) Hole Size
Panel Range: 2mm - 4.5mm
Flange Diameter: 18mm
Black Nylon
Push Type Retainers

25 Pcs.

10369PK



17/64" (6.5mm) Hole Size
Panel Range: 4.5mm - 7mm
Flange: 18mm Stem: 20mm
Black Nylon
Push Type Retainers

50 Pcs.

10367PK



17/64" (6.5mm) Hole Size
Panel Range: 7mm - 9.5mm
Flange: 14mm Stem: 22mm
Black Nylon
Push Type Retainers

25 Pcs.

10537PK



17/64" (6.5mm) Hole Size
Flange Diameter: 18mm
Stem Length: 7mm
Black Nylon
Fender Liner Retainers

15 Pcs.

10825PK



17/64" (6.5mm) Hole Size
Flange Diameter: 15mm
Stem Length: 14mm
Black Nylon
Cowl Vent Retainers

15 Pcs.

9114PK



17/64" (7mm) Hole Size
Flange Diameter: 18mm
Stem Length: 16mm
Black Nylon
Push Type Retainers

25 Pcs.

Metropolitan Supply

9465PK



17/64" (7mm) Hole Size
Flange: 20mm Stem: 10mm
Black Nylon
Front Fender Liner
Push Type Retainers

15 Pcs.

10623PK



17/64" (7mm) Hole Size
Flange Diameter: 15mm
Stem Length: 17mm
Black Nylon
Push Type Retainers

15 Pcs.

10512PK



17/64" (7mm) Hole Size
Flange Diameter: 20mm
Stem Length: 17mm
Black Nylon
Side Radiator Shield Retainers

25 Pcs.

5676PK



5/16" (7.8mm) Hole Size
Flange: 17mm Stem: 13.5mm
Black Nylon
Radiator & Windshield
Bottle Retainers

25 Pcs.

10940PK



5/16" (8mm) Hole Size
Flange: 12.5mm Stem: 11mm
Black Nylon
Fender Splash Shield, Hood &
Truck Insulator Rivets

25 Pcs.

10948PK



5/16" (8mm) Hole Size
Flange Diameter: 16mm
Stem Length: 11mm
Black Nylon
Push Type Retainers

25 Pcs.

Metropolitan Supply

10616PK

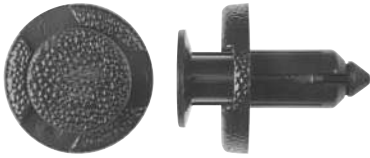

15/16" (8mm) Hole Size
Flange: 20mm Stem: 13mm
Black Nylon
Front Bumper &
Radiator Support Retainers

25 Pcs.

9540PK



5/16" (8mm) Hole Size
Flange Diameter: 20mm
Stem Length: 13mm
Black Nylon
Push Type Retainers

15 Pcs.

10536PK



5/16" (8mm) Hole Size
Head Diameter: 18mm
Stem Length: 12mm
Black Nylon
Bumper Clip Retainers

15 Pcs.

9292PK



5/16" (8mm) Hole Size
Flange: 20mm Stem: 10mm
Black Nylon
Front Fender
Push Type Retainers

15 Pcs.

2128PK



5/16" (8mm) Hole Size
Flange Diameter: 20mm
Stem Length: 11mm
Black Nylon
Push Type Retainers

25 Pcs.

2057PK

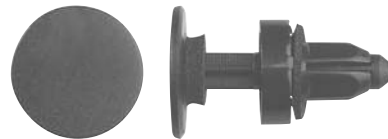

5/16" (8mm) Hole Size
Head: 18mm Stem: 14mm
Black Nylon With Sealer
Cowl Panel
Push Type Retainers

10 Pcs.

10798PK



5/16" (8mm) Hole Size
Flange: 20mm Stem: 14mm
Black Nylon
Front Bumper
Push Type Retainers

15 Pcs.

9390PK



5/16" (8mm) Hole Size
Flange Diameter: 20mm
Stem Length: 14mm
Black Nylon
Push Type Retainers

25 Pcs.

2056PK

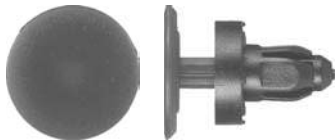

5/16" (8mm) Hole Size
Head: 17mm Stem: 11mm
Black Nylon
Cowl Panel
Push Type Retainers

10 Pcs.

1975PK



5/16" (8mm) Hole Size
Flange Diameter: 16mm
Stem Length: 20mm
Black Nylon
Push Type Retainers

25 Pcs.

1949PK



5/16" (8mm) Hole Size
Flange: 20mm Stem: 15mm
Black Nylon
Front & Rear Bumper Cover
Push Type Retainers

15 Pcs.

1861PK



5/16" (8mm) Hole Size
Flange Diameter: 15mm
Stem Length: 20mm
Black Nylon
Rocker Panel Retainers

25 Pcs.

Metropolitan Supply

10511PK



5/16" (8mm) Hole Size
Flange Diameter: 18mm
Stem Length: 20mm
Black Nylon
Rear Bumper Retainers

15 Pcs.

1860PK



5/16" (8mm) Hole Size
Flange Diameter: 20mm
Stem Length: 20mm
Black Nylon
Push Type Retainers

25 Pcs.

5940PK

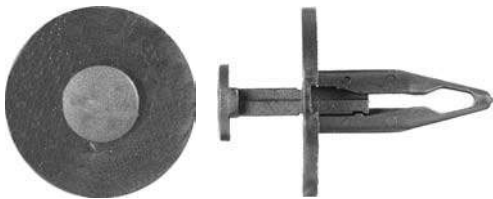

5/16" (8mm) Hole Size
Panel Range: 3.5mm - 7.9mm
Flange: 25mm Stem: 23mm
Black Nylon
Spare Tire Blind Rivets

25 Pcs.

1263PK



5/16" (8mm) Hole Size
Flange: 1" Shoulder: 7/64"
Stem Length: 29/32"
Black Nylon
Splash Shield & Fascia Ret.

25 Pcs.

2133PK



5/16" (8mm) Hole Size
Flange Diameter: 18mm
Stem Length: 23mm
Black Nylon
Fascia Push Type Retainers

25 Pcs.

10075PK

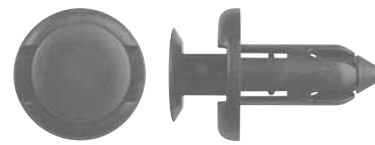

5/16" (8mm) Hole Size
Flange: 18mm Stem: 19mm
Black Nylon
Garnish Side Protector
Push Type Retainers

15 Pcs.

Metropolitan Supply

10370PK



5/16" (8mm) Hole Size
Panel Range: 5mm - 7mm
Flange: 19mm Stem: 16mm
Black Nylon
Push Type Retainers

25 Pcs.

10503PK



5/16" (8mm) Hole Size
Flange Diameter: 18.5mm
Stem Length: 21mm
Black Nylon With Sealer
Rear Bumper Retainers

10 Pcs.

10504PK



5/16" (8mm) Hole Size
Flange Diameter: 20mm
Stem Length: 26mm
Black Nylon
Fender Shield Retainers

15 Pcs.

10669PK



5/16" (8mm) Hole Size
Flange: 16.5mm Stem: 27mm
Black Nylon
Bumper & Rear Wheel Apron
Push Type Retainers

25 Pcs.

9357PK



5/16" (8mm) Hole Size
Flange Diameter: 20mm
Stem Length: 28mm
Black Nylon
Bumper Facia Retainers

25 Pcs.

10673PK

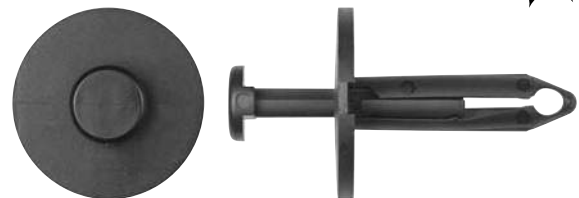

5/16" (8mm) Hole Size
Flange Diameter: 25mm
Stem Length: 30mm
Black Nylon
Bumper Cover Retainers

10 Pcs.

Metropolitan Supply

10496PK

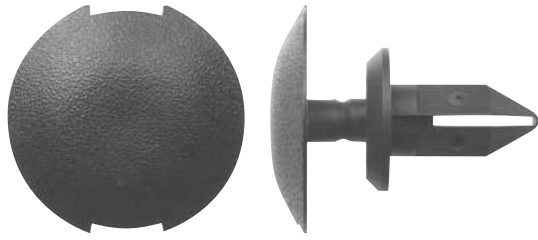

5/16" (8mm) Square Hole Size
Head Diameter: 31mm
Stem Length: 21mm
Black Nylon
Tail Light Retainers

15 Pcs.

10460PK



5/16" (8mm) Hole Size
Flange: 34mm Shoulder: 3.5mm
Stem Length: 20.5mm
Black & Natural Nylon
Front Bumper Fascia Retainers

15 Pcs.

10928PK



11/32" (8.5mm) Hole Size
Flange Diameter: 16mm
Stem Length: 13.5mm
Black Nylon
Push Type Retainers

50 Pcs.

10239PK



21/64" (8.5mm) Hole Size
Panel Range: 2.7mm - 5.3mm
Flange: 19mm Stem: 14mm
Black Nylon
Push Type Retainers

50 Pcs.

10371PK

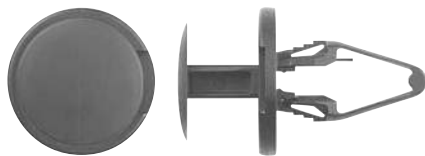

21/64" (8.5mm) Hole Size
Panel Range: 2mm - 4.5mm
Flange: 20mm Stem: 20.5mm
Black Nylon
Push Type Retainers

25 Pcs.

10374PK

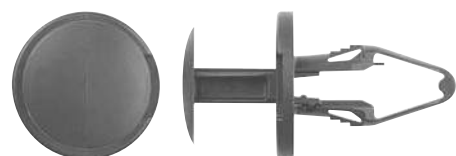

21/64" (8.5mm) Hole Size
Panel Range: 4.5mm - 7mm
Flange: 20mm Stem: 22mm
Black Nylon
Push Type Retainers

25 Pcs.

10372PK



21/64" (8.5mm) Hole Size
 Panel Range: 7mm - 10mm
 Flange: 20mm Stem: 24mm
 Black Nylon
 Push Type Retainers

25 Pcs.

10542PK



21/64" (8.5mm) Hole Size
 Flange: 34mm Shoulder: 3.5mm
 Stem Length: 17mm
 Black & White Nylon With Sealer
 Bumper Retainers

10 Pcs.

10499PK



23/64" (9mm) Hole Size
 Flange Diameter: 22mm
 Stem Length: 10mm
 Tan Nylon
 Door Trim Panel Retainers

25 Pcs.

10516PK

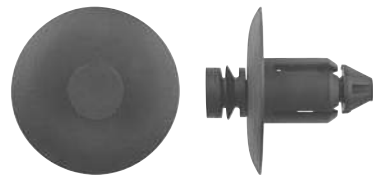

23/64" (9mm) Hole Size
 Flange Diameter: 22mm
 Stem Length: 10mm
 Black Nylon
 Door Trim Panel Retainers

25 Pcs.

9943PK



23/64" (9mm) Hole Size
 Flange: 18mm Stem: 13mm
 Black Nylon
 Fender & Bumper
 Push Type Retainers

15 Pcs.

10247PK

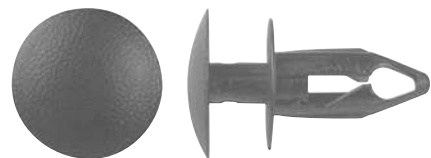

23/64" (9mm) Hole Size
 Flange: 20mm Stem: 21mm
 Black Nylon
 Rear Bumper Cover
 Push Type Retainers

25 Pcs.

Metropolitan Supply

10356PK

NEW!

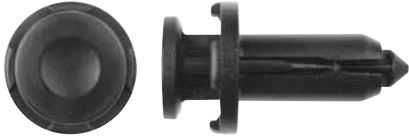

23/64" (9mm) Hole Size
Flange: 18mm Stem: 31mm
Black Nylon
Bumper Cover & Grille
Push Type Retainers

10 Pcs.

9327PK



11/32" (9mm) Hole Size
Flange: 18mm Stem: 28mm
Black Nylon
Rear Bumper Cover
Push Type Retainers

4 Pcs.

10628PK

NEW!



23/64" (9mm) Hole Size
Flange: 18mm Stem: 31mm
Black Nylon
Bumper Cover & Grille
Push Type Retainers

15 Pcs.

10824PK

NEW!



3/8" (9.5mm) Hole Size
Top Head Diameter: 12mm
Stem Length: 13mm
Black Nylon
Trim Panel Retainers

15 Pcs.

10375PK

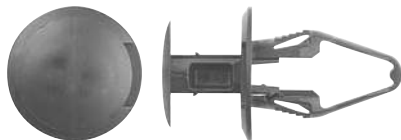

3/8" (9.5mm) Hole Size
Panel Range: 2.95mm - 5.75mm
Flange: 18mm Stem: 20mm
Black Nylon
Push Type Retainers

25 Pcs.

10674PK

NEW!



3/8" (9.5mm) Hole Size
Flange: 1" Shoulder: 5/32"
Stem Length: 15/16"
Black Nylon
Rear Bumper Fascia Retainers

25 Pcs.

Metropolitan Supply

9370PK



3/8" (9.5mm) Hole Size
 Flange Diameter: 18mm
 Stem Length: 23mm
 Black Nylon
 Front Bumper Fascia Retainers

25 Pcs.

10666PK



3/8" (9.5mm) Hole Size
 Flange Diameter: 21mm
 Stem Length: 23mm
 Black Nylon
 Tail Light Housing Retainers

25 Pcs.

5677PK



3/8" (9.5mm) Hole Size
 Flange Diameter: 1"
 Stem Length: 11/16"
 Black Nylon
 Fascia Retainers

25 Pcs.

10522PK

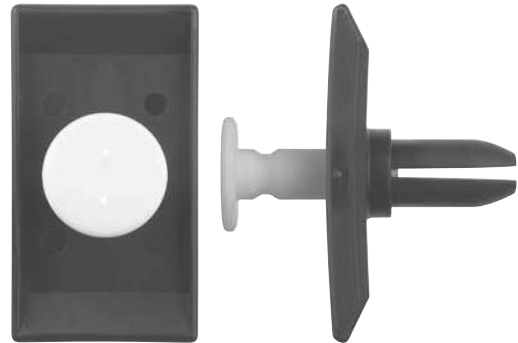

3/8" (9.5mm) Hole Size
 Flange: 25mm x 45mm Shold: 3mm Stem: 20.5mm
 Black & Natural Nylon Bumper Cover Retainers

15 Pcs.

10681PK



25/64" (10mm) Hole Size
 Flange Diameter: 20mm
 Stem Length: 13mm
 Black Nylon With Metal Insert
 Front Bumper Retainers

10 Pcs.

10625PK



25/64" (10mm) Hole Size
 Flange Diameter: 20mm
 Stem Length: 14mm
 Black Nylon
 Grille Mounting Retainers

15 Pcs.

Metropolitan Supply

9294PK



25/64" (10mm) Hole Size
Flange Diameter: 18mm
Stem Length: 15mm
Black Nylon
Push Type Retainers

15 Pcs.

9282PK



25/64" (10mm) Hole Size
Flange: 20mm Stem: 16mm
Black Nylon
Front Bumper
Push Type Retainers

15 Pcs.

10955PK

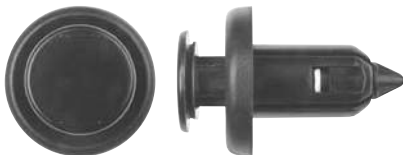

25/64" (10mm) Hole Size
Flange Diameter: 20mm
Stem Length: 16mm
Black Nylon With Metal Insert
Bumper Retainers

10 Pcs.

9382PK



25/64" (10mm) Hole Size
Flange: 20mm Stem: 18mm
Black Nylon
Front & Rear Bumper
Push Type Retainers

15 Pcs.

5678PK



25/64" (10mm) Hole Size
Flange Diameter: 16mm
Stem Length: 12.5mm
Natural Nylon
Push Type Retainers

25 Pcs.

10518PK



25/64" (10mm) Hole Size
Flange Diameter: 20mm
Stem Length: 16mm
Black Nylon
Radiator Grille Retainers

25 Pcs.

Metropolitan Supply

10500PK



25/64" (10mm) Hole Size
Flange Diameter: 18mm
Stem Length: 26mm
Black Nylon
Door Trim Panel Retainers

25 Pcs.

10502PK



25/64" (10mm) Hole Size
Flange Diameter: 18mm
Stem Length: 26mm
Black Nylon
Bumper Cover Retainers

25 Pcs.

2026PK



25/64" (10mm) Hole Size
Panel Range: 20mm
Flange: 20mm Stem: 21mm
Black Nylon
Front Bumper Fascia Retainers

25 Pcs.

10377PK

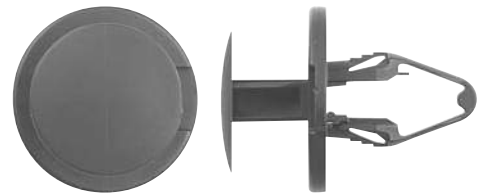

25/64" (10mm) Hole Size
Panel Range: 3mm - 6mm
Flange: 25mm Stem: 20mm
Black Nylon
Push Type Retainers

15 Pcs.

10378PK

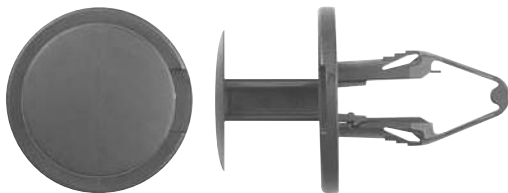

13/32" (10.5mm) Hole Size
Panel Range: 6mm - 9mm
Flange: 25mm Stem: 22.5mm
Black Nylon
Push Type Retainers

15 Pcs.

10519PK

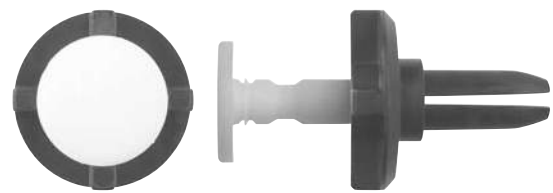

17/16" (11mm) Hole Size
Flange: 24mm Shoulder: 4mm
Stem Length: 20mm
Black Nylon
Front Bumper Retainers

15 Pcs.

9592PK



17/16" (11mm) Hole Size
 Flange Diameter: 1 3/16"
 Stem Length: 2"
 Black Nylon
 Fascia Push Type Retainers

10 Pcs.

10714PK

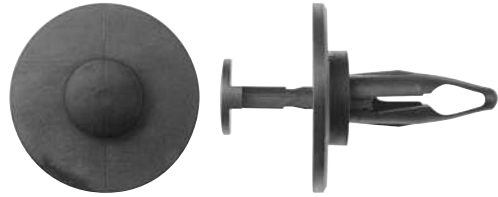

1/2" (12.7mm) Hole Size
 Flange: 1" Shoulder: 7/64"
 Stem Length: 15/16"
 Black Nylon
 Plastic Cover On Engine Ret.

25 Pcs.

1447PK



1/2" (12.7mm) Hole Size
 Flange: 1" Shoulder: 1/4"
 Stem Length: 1 1/8"
 Black Nylon
 Bumper Fascia Retainers

25 Pcs.

1448PK



1/2" (12.7mm) Hole Size
 Flange: 7/8" Shoulder: 3/16"
 Stem Length: 1 3/64"
 Black Nylon
 Bumper Fascia Retainers

25 Pcs.

5672PK



1/2" (12.7mm) Hole Size
 Flange: 1" Shoulder: 1/8"
 Stem Length: 3/4"
 Black Nylon
 Bumper Pad Blind Rivets

25 Pcs.

1234PK



1/2" (12.7mm) Hole Size
 Flange: 7/8" Shoulder: 5/32"
 Stem Length: 25/32"
 Blue Nylon
 Fascia Retainers

25 Pcs.

Metropolitan Supply

5680PK



1/2" (12.7mm) Hole Size
Flange: 1" Shoulder: 3mm
Stem Length: 1"
Black Nylon
Bumper Fascia Blind Rivets

25 Pcs.

2050PK

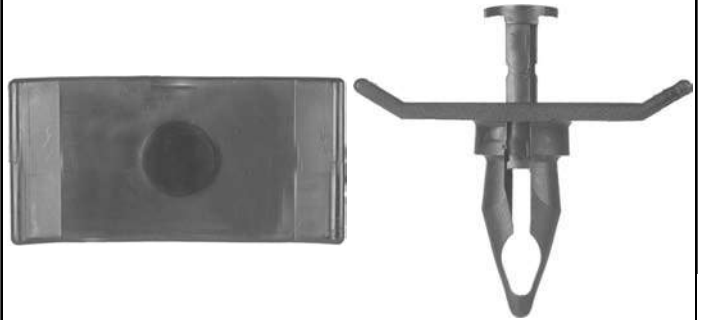

1/2" (12.7mm) Hole Size
Flange: 7/8" x 1 25/32"
Shoulder: 3/16" Stem: 1 1/16"
Black Nylon
Rear Fascia Retainers

15 Pcs.

10382PK

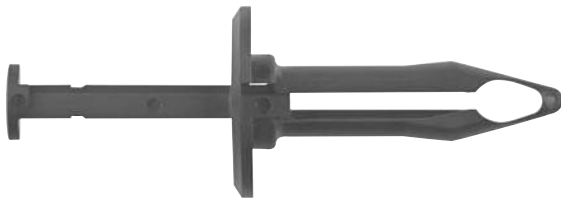

1/2" (12.7mm) Hole Size
Flange: 1" Shoulder: 9/64"
Stem Length: 1 5/8"
Black Nylon Front
License Plate Retainers

5 Pcs.

10535PK



19/32" (15mm) Hole Size
Flange: 22mm Stem: 13mm
Black Nylon
Rocker Moulding
Push Type Retainers

10 Pcs.

10686PK



13/64" (5mm) Hole Size
Flange Diameter: 10mm
Stem Length: 12mm
Black Nylon
Front Fascia Retainers

25 Pcs.

9108PK



15/64" (6mm) Hole Size
Flange Diameter: 20mm
Stem Length: 9mm
Black Nylon
Push Type Retainers

15 Pcs.

10615PK



15/64" (6mm) Hole Size
Flange Diameter: 14mm
Stem Length: 9mm
Black Nylon
Belt Moulding Push Type Retainers

15 Pcs.

1999PK

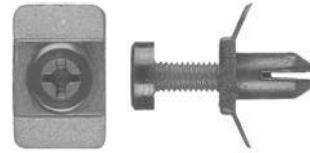

15/64" (6mm) Hole Size
Flange Dia.: 12mm x 18mm
Stem Length: 10mm
Black Nylon
Push Type Retainers

15 Pcs.

1597PK



15/64" (6mm) Hole Size
Flange Diameter: 15mm
Stem Length: 11mm
Black Nylon
Push Type Retainers

25 Pcs.

5930PK



1/4" (6mm) Hole Size
Flange Diameter: 18mm
Stem Length: 11mm
Black Nylon
Vent Panel Blind Rivets

25 Pcs.

2028PK



15/64" (6mm) Hole Size
Flange: 14mm Stem: 16mm
Black Nylon
Cowl Panel to Reinf. Plate &
Engine Splash Shield Retainers

25 Pcs.

9783PK



15/64" (6mm) Hole Size
Flange Diameter: 11mm
Stem Length: 20mm
Black Nylon
Rocker Panel Retainers

25 Pcs.

10468PK



1/4" (6.3mm) Hole Size
Flange Diameter: 11/16"
Stem Length: 3/4"
Black Nylon
Trim Panel Retainers

15 Pcs.

9968PK



1/4" (6.3mm) Hole Size
Flange Diameter: 5/8"
Stem Length: 29/32"
Black Nylon
Exterior Blind Rivets

50 Pcs.

9067PK



1/4" (6.3mm) Hole Size
Flange Diameter: 11/16"
Stem Length: 29/32"
Black Nylon
Radiator Shroud Blind Rivets

25 Pcs.

1399PK



1/4" (6.3mm) Square Hole
Flange Dia.: 15/32" x 15/32"
Flange Diameter: 21/32"
Black Nylon
Trim & Grille Fascia Retainers

25 Pcs.

9509PK

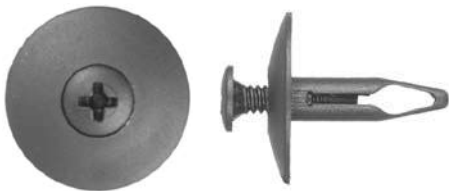

1/4" (6.3mm) Hole Size
Flange Diameter: 1"
Stem Length: 7/8"
Black Nylon
Interior Trim Retainers

50 Pcs.

10716PK



17/64" (7mm) Hole Size
Flange Diameter: 20mm
Stem Length: 8mm
Black Nylon
Garnish Moulding Retainers

15 Pcs.



Metropolitan Supply

2015PK



17/64" (7mm) Hole Size
Flange Diameter: 14mm
Stem Length: 11mm
Black Nylon
Push Type Retainers

25 Pcs.

2155PK



17/64" (7mm) Square Hole Size
Flange Diameter: 15mm
Stem Length: 13mm
Black Nylon
Push Type Retainers

25 Pcs.

10413PK



17/64" (7mm) Hole Size
Flange: 20mm Stem: 9mm
Black Nylon
Quarter Panel
Moulding Retainers

10 Pcs.

2143PK



17/64" (7mm) Hole Size
Flange Diameter: 20mm
Stem Length: 12mm
Black Nylon
Push Type Retainers

10 Pcs.

1603PK



17/64" (7mm) Hole Size
Flange Diameter: 15mm
Stem Length: 12mm
Black Nylon
Push Type Retainers

15 Pcs.

10614PK



17/64" (7mm) Hole Size
Flange Diameter: 14mm
Stem Length: 23mm
Black Nylon
Push Type Retainers

15 Pcs.

5920PK



5/16" (8mm) Hole Size
Flange Diameter: 20mm
Stem Length: 9mm
Black Nylon
Splash Shield Blind Rivets

25 Pcs.

10538PK



5/16" (8mm) Hole Size
Flange Diameter: 20mm
Stem Length: 20mm
Black Nylon
Front Bumper Fascia Retainers

15 Pcs.

1446PK



5/16" (8mm) Hole Size
Flange Diameter: 19/32"
Stem Length: 13/16"
Black Nylon
Push Type Retainers

25 Pcs.

10523PK

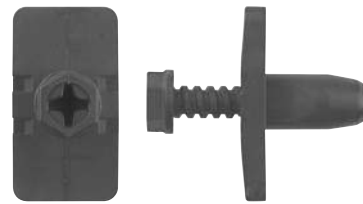

5/16" (8mm) Hole Size
Flange Dia.: 14mm x 26mm
Stem Length: 14mm
Black Nylon
Front Bumper Retainers

50 Pcs.

1265PK



5/16" (8mm) Hole Size
Flange Diameter: 17mm
Stem Length: 18mm
Black Nylon
Push Type Retainers

25 Pcs.

1973PK



5/16" (8mm) Hole Size
Flange Diameter: 18mm
Stem Length: 21mm
Black Nylon
Push Type Retainers

10 Pcs.

5901PK



5/16" (8mm) Hole Size
Flange Diameter: 20mm
Stem Length: 18mm
Black Nylon
Inter Fender Shield Blind Rivets

25 Pcs.

1976PK



5/16" (8mm) Hole Size
Flange: 20mm Stem: 9mm
Black Nylon
Fender Splash Shield
Push Type Retainers

10 Pcs.

10747PK



5/16" (8mm) Hole Size
Flange Diameter: 20mm
Stem Length: 9mm
Black Nylon
Mud Guard Push Type Retainers

15 Pcs.

9287PK



5/16" (8mm) Hole Size
Flange Diameter: 18mm
Stem Length: 12mm
Black Nylon
Push Type Retainers

10 Pcs.

1972PK



5/16" (8mm) Hole Size
Flange Diameter: 20mm
Stem Length: 15mm
Hex Phillips Drive Splash Shield
Push Type Retainers

10 Pcs.

10914PK



5/16" (8mm) Hole Size
Flange Diameter: 13mm
Stem Length: 18mm
Black Nylon
Bumper Push Type Retainers

15 Pcs.

2163PK



5/16" (8mm) Hole Size
Flange Diameter: 20 mm
Stem Length: 21mm
Black Nylon
Push Type Retainers

5 Pcs.

10624PK



23/64" (9mm) Hole Size
Flange Diameter: 20mm
Stem Length: 9mm
Black Nylon
Push Type Retainers

15 Pcs.

2027PK



23/64" (9mm) Hole Size
Flange: 15mm Stem: 16mm
Black Nylon
Bumper Cover
Push Type Retainers

15 Pcs.

1943PK



23/64" (9mm) Hole Size
Flange: 18mm Stem: 23mm
Black Nylon
Bumper Cover
Push Type Retainers

25 Pcs.

5895PK



23/64" (9mm) Hole Size
Flange Diameter: 15mm
Stem Length: 27mm
Black Nylon
Bumper Cover Blind Rivets

10 Pcs.

9202PK



25/64" (10mm) Hole Size
Flange Diameter: 20mm
Stem Length: 15mm
Black Nylon
Push Type Retainers

15 Pcs.

1998PK

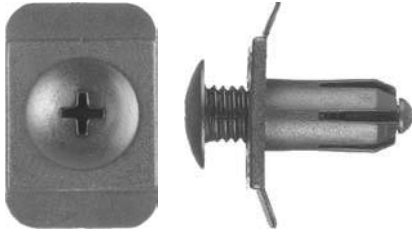

25/64" (10mm) Hole Size
Flange Dia.: 20mm x 30mm
Stem Length: 18mm
Black Nylon
Bumper Cover Retainers

10 Pcs.

D-124PK



25/64" (10mm) Hole Size
Flange Diameter: 20mm
Stem Length: 24mm
Black Nylon
Bumper Fascia Retainers

10 Pcs.

2060PK



25/64" (10mm) Hole Size
Flange Diameter: 20mm
Stem Length: 25mm
Black Nylon
Bumper Retainers

10 Pcs.

D-123PK



25/64" (10mm) Hole Size
Flange Diameter: 20mm
Stem Length: 27mm
Black Nylon
Bumper Fascia Retainers

10 Pcs.

2153PK



7/16" (11mm) Hole size
Flange: 22mm Shoulder: 3.5mm
Stem Length: 14mm
Black Nylon
Bumper & Fascia Retainers

15 Pcs.

1730PK

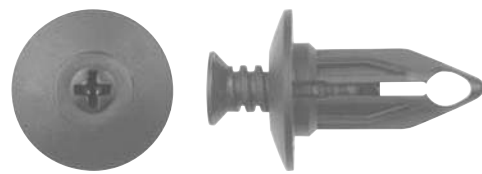

31/64" (12mm) Hole Size
Flange: 21mm Shoulder: 3mm
Stem Length: 25mm
Black Nylon
Rear Bumper Fascia Retainers

25 Pcs.

Metropolitan Supply

2077PK



1/4-20" by 1/4" Hole Size
Flange Diameter: 9/16"
Over All Length: 1"
Black Nylon
Cowl Screen Retainers
(Use with # 2076)

25 Pcs.

2076PK

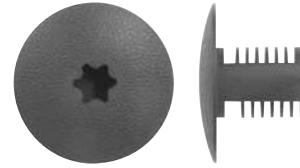

Flange: 13/16" Stem: 15/32"
Black Nylon
Cowl Top Stud
Retainer Cover
(Use with # 2077)

25 Pcs.

10678PK



Stem Diameter: 4.1mm
Stem Length: 15mm
Black Nylon
Cowl Screen Pin Retainers
Use with # 10618

25 Pcs.

10618PK



Head Dia.: 13mm x 13mm
Stem Length: 13mm
White Nylon With Sealer
Cowl Vent Grommets
Use with # 10678

15 Pcs.

10621PK



4mm Hole Size
Top Head Diameter: 13mm
Stem Length: 13mm
White Nylon
Cowl Vent Retainers

25 Pcs.

9694PK



Flange Diameter: 30mm
Stem Length: 24mm
Black Nylon
Front Air Deflector Retainers
(Use With # 9695)

15 Pcs.

9695PK

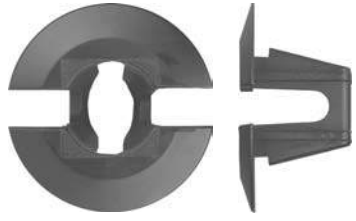

Flange Diameter: 28mm
Stem Length: 13mm
Black Nylon
Front Air Deflector Grommets
(Use With # 9694)

25 Pcs.

10540PK



13mm x 9mm Hole Size
Flange Dia.: 19mm x 30mm
Stem Length: 15mm
Black & Gray Nylon
Radiator Grille Retainers

10 Pcs.



Windshield Fasteners

Metropolitan Supply

816PK



Rear Window
Reveal Moulding Clips
G.M. # 4533699
100 Pcs.

9548PK



Windshield & Rear
Window
Reveal Moulding Clips
G.M. # 20603072
100 Pcs.

2065PK



Windshield & Rear
Window
Reveal Moulding Clips
G.M. # 9808241
50 Pcs.

9898PK



Windshield Upper & Lower
Reveal Moulding Clips
G.M. # 7698976
100 Pcs.

825PK



Rear Window
Reveal Moulding Clips
G.M. # 8717859
100 Pcs.

9899PK



Windshield
Reveal Moulding Clips
G.M. # 9895598
50 Pcs.

Metropolitan Supply

817PK



Windshield, Skylight
Quarter & Rear Windshield
Reveal Moulding Clips
G.M. # 7730788
50 Pcs.

9546PK



Windshield & Rear Window
Reveal Moulding Clips
G.M. # 7693140
50 Pcs.

986PK



White Nylon
Windshield & Rear Window
Reveal Moulding Clips
G.M. # 1654047
100 Pcs.

985PK



White Nylon
Windshield to Panel
Reveal Moulding Clips
G.M. # 9731301
100 Pcs.

1371PK



Windshield & Backlite
Reveal Moulding Clips
Ford # E3SB6342413AB
50 Pcs.

9874PK



Rear Window
Reveal Moulding Clips
Ford # C6AB-6242413-A
100 Pcs.

Metropolitan Supply

9550PK



Windshield & Rear Window
Reveal Moulding Clips
Ford # C5ZZ-6543413-B
100 Pcs.

9545PK



Windshield & Rear Window
Reveal Moulding Clips
Ford # C8AZ-63642413-A
100 Pcs.

9504PK



Windshield & Backlite
Reveal Moulding Clips
Chrysler # 6003752
50 Pcs.

9547PK



9/32" (7mm) Square Hole Size
7/64" (3mm) I.D. Hose
13/64" (5mm) O.D. Hose
Natural Nylon
Windshield Washer Hose Retainers
15 Pcs.

1994PK



Gray Nylon
Windshield Washer
Hose Clips
15 Pcs.

10727PK

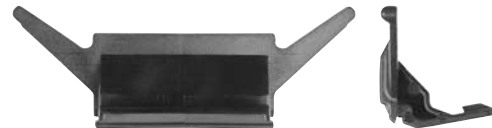

22mm Wide
46mm Length
Black Nylon
Windshield Moulding Clips
Nissan
25 Pcs.

The image features a variety of door fasteners and hardware components scattered across the page. These include different types of screws, bolts, nuts, washers, and specialized fasteners like door hinges, door pulls, and door latches. The components are shown in various orientations and positions, creating a sense of a comprehensive product line. The central text 'Door Fasteners' is prominently displayed in a large, bold, black font, with the word 'Door' on the top line and 'Fasteners' on the bottom line. The background is plain white, which makes the metallic and plastic parts stand out clearly.

Door Fasteners

Metropolitan Supply

812PK



Bright Zinc Finish
Door Window
Crank Handle
Retaining Clips
100 Pcs.

9507PK



9/16" I.D.
11/16" O.D.
3/4" Long
PVC Plastic
Door Lock Stricker Bushings
25 Pcs.

9731PK



5/32" Rod Size
Hole Size: 6mm
Orange Nylon
Door Lock Rod Clips
100 Pcs.

9437PK



5/32" Rod Size
Hole Size: 15/64"
Left Hand Side
Black Nylon
Door Lock Rod Clips
25 Pcs.

9438PK



5/32" Rod Size
Hole Size: 15/64"
Right Hand Side
Natural Nylon
Door Lock Rod Clips
25 Pcs.

9987PK

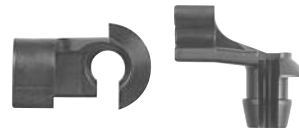

5/32" Rod Size
Hole Size: 15/64"
Left Hand Side
Black Nylon
Door Lock Rod Clips
25 Pcs.

Metropolitan Supply

9986PK

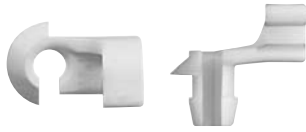

5/32" Rod Size
Hole Size: 15/64"
Right Hand Side
Natural Nylon
Door Lock Rod Clips

25 Pcs.

9960PK



5/32" Rod Size
Hole Size: 15/64"
Left Hand Side
Black Nylon
Door Lock Rod Clips

25 Pcs.

9959PK

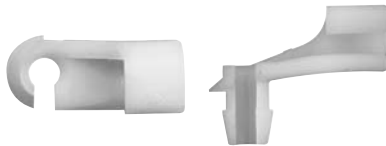

5/32" Rod Size
Hole Size: 15/64"
Right Hand Side
Natural Nylon
Door Lock Rod Clips

25 Pcs.

9981PK

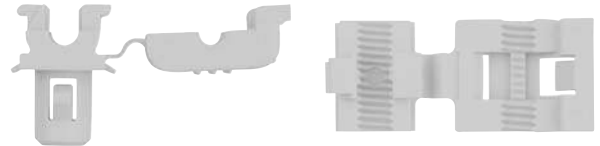

10-24 Rod Size
Panel Range: 2mm
Hole Size: 8mm
Yellow Nylon
Door Lock & Tailgate Rod Clips

15 Pcs.

10083PK



Fits a Oblong Hole
Right & Left Side
Black Nylon
Door Rod End Clips
G.M. # 15685073

25 Pcs.

10082PK



5/16" Rod Size
Natural Nylon
Hood Prop Rod Clips
G.M. # 21097292

15 Pcs.

Metropolitan Supply

10084PK

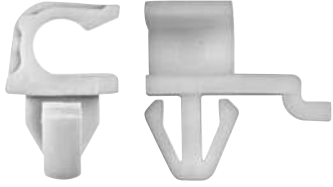

7mm Rod Size
Hole Size: 10mm
Natural Nylon
Hood Prop Rod Clips
G.M. # 15021761
10 Pcs.

1083PK



Door Lock
Rod End Clips
G.M. # 4234830
25 Pcs.

9726PK



5/32" Rod Size
Hole Size: 17/64"
Left Hand Side
Black Nylon
Door Rod & Hood Clips

50 Pcs.

9725PK



5/32" Rod Size
Hole Size: 17/64"
Right Hand Side
Natural Nylon
Door Rod & Hood Clips

20 Pcs.

9728PK

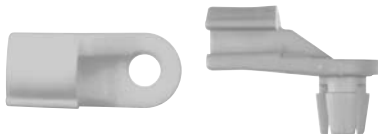

5/32" Rod Size
Hole Size: 17/64"
Left Hand Side
Yellow Nylon
Door Lock Rod Clips

25 Pcs.

10078PK



#10-24 Rod Size
Hole Size: 8mm
White Nylon
Fold Over Type
Door Lock Rod Clips

10 Pcs.

Metropolitan Supply

10080PK



#10-24 Rod Size
Folder Over Type
Yellow Nylon
Door Lock Rod Clips

10 Pcs.

9729PK



5/32" Rod Size
Hole Size: 17/64"
Right Hand Side
Natural Nylon
Door Lock Rod Clips

25 Pcs.

10079PK

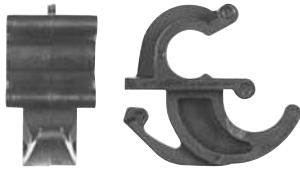

1/4" Rod Size
Black Nylon
Hood Prop Rod Clips

25 Pcs.

10081PK

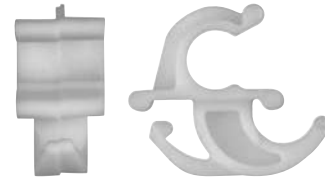

5/16" Rod Size
Natural Nylon
Hood Prop Rod Clips

10 Pcs.

10076PK



5/16" Rod Size
Natural Nylon
Hood Prop Rod Clips

25 Pcs.

10077PK

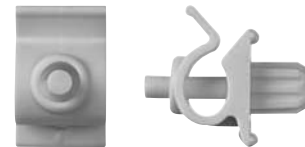

6mm Rod Size
Square Hole Size: 7mm
Yellow Nylon
Hood Prop Rod Clips

5 Pcs.

Metropolitan Supply

9963PK



5/32" Rod Size
Hole Size: 15/64"
Left Hand Side
Green Nylon
Door Lock Rod Clips

25 Pcs.

9962PK

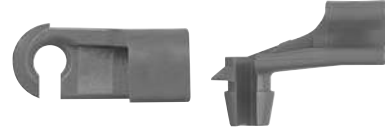

5/32" Rod Size
Hole Size: 15/64"
Right Hand Side
Red Nylon
Door Lock Rod Clips

25 Pcs.

1250PK



5/32" Rod Size
Hole Size: 15/64"
Left Hand Side
Green Nylon
Door Lock Rod Clips

50 Pcs.

1249PK

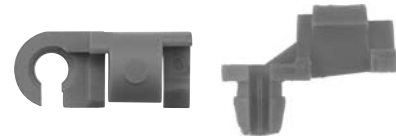

5/32" Rod Size
Hole Size: 15/64"
Right Hand Side
Red Nylon
Door Lock Rod Clips

50 Pcs.

9384PK

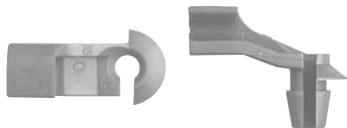

1/8" Rod Size
Hole Size: 13/64"
Left Hand Side
Orange Nylon
Door Lock Rod Clips

25 Pcs.

9961PK

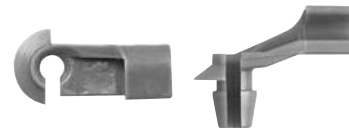

1/8" Rod Size
Hole Size: 13/64"
Right Hand Side
Purple Nylon
Door Lock Rod Clips

25 Pcs.

Metropolitan Supply

9988PK



5/16" Rod Size
1 3/8" O.A. Length
Black Nylon
Hood Prop Rod Clips

10 Pcs.

10229PK

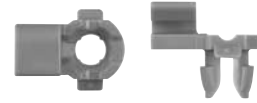

3.4mm Rod Size
Hole Size: 6mm
Left Hand Side
Purple Nylon
Door Rod End Clips

25 Pcs.

10230PK



3.4mm Rod Size
Hole Size: 6mm
Right Hand Side
Yellow Nylon
Door Rod End Clips

25 Pcs.

10225PK

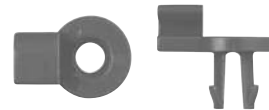

3.5mm Rod Size
Hole Size: 5mm
Left Hand Side
Black Nylon
Door Rod End Clips

25 Pcs.

10226PK



3.5mm Rod Size
Hole Size: 5mm
Right Hand Side
Brown Nylon
Door Rod End Clips

25 Pcs.

10121PK



3.5mm Rod Size
Hole Size: 6mm
Left Hand Side
Brown Nylon
Door Rod End Clips

25 Pcs.

Metropolitan Supply

10122PK



3.5mm Rod Size
Hole Size: 6mm
Right Hand Side
Blue Nylon
Door Rod End Clips

25 Pcs.

10227PK



3.5mm Rod Size
Hole Size: 6mm
Left Hand Side
Natural Nylon
Door Rod End Clips

25 Pcs.

10228PK



3.5mm Rod Size
Hole Size: 6mm
Right Hand Side
Purple Nylon
Door Rod End Clips

25 Pcs.

10235PK



3.5mm Rod Size
Hole Size: 6mm
Left Hand Side
Brown Nylon
Door Rod End Clips

25 Pcs.

10236PK



3.5mm Rod Size
Hole Size: 6mm
Right Hand Side
Blue Nylon
Door Rod End Clips

25 Pcs.

10237PK



3.6mm Rod Size
Hole Size: 6mm
Left Hand Side
Black Nylon
Door Rod End Clips

25 Pcs.

Metropolitan Supply

10238PK



3.6mm Rod Size
Hole Size: 6mm
Right Hand Side
Natural Nylon
Door Rod End Clips

25 Pcs.

10233PK



3.9mm Rod Size
Hole Size: 7mm
Left Hand Side
Blue Nylon
Door Rod End Clips

25 Pcs.

10234PK



3.9mm Rod Size
Hole Size: 7mm
Right Hand Side
Pink Nylon
Door Rod End Clips

25 Pcs.

10231PK



4mm Rod Size
Hole Size: 6mm
Left Hand Side
Yellow Nylon
Door Rod End Clips

25 Pcs.

10232PK



4mm Rod Size
Hole Size: 6mm
Right Hand Side
Purple Nylon
Door Rod End Clips

25 Pcs.

10216PK



4.2mm Rod Size
Hole Size: 6mm
Left Hand Side
Purple Nylon
Door Rod End Clips

25 Pcs.

Metropolitan Supply

10217PK



4.2mm Rod Size
Hole Size: 6mm
Right Hand Side
Orange Nylon
Door Rod End Clips

25 Pcs.

10114PK

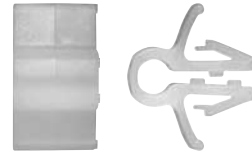

6mm Rod Size
Hole Size: 7mm
Universal
Natural Nylon
Door Rod Clips

15 Pcs.

10223PK



4.2mm Rod Size
Hole Size: 7mm
Left Hand Side
Blue Nylon
Door Rod End Clips

25 Pcs.

10224PK



4.2mm Rod Size
Hole Size: 7mm
Right Hand Side
Black Nylon
Door Rod End Clips

25 Pcs.

10199PK

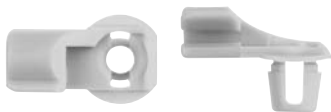

3.5mm Rod Size
Hole Size: 6.5mm
Left Hand Side
Cream Nylon
Door Rod End Clips

25 Pcs.

10198PK



3.5mm Rod Size
Hole Size: 6.5mm
Right Hand Side
Purple Nylon
Door Rod End Clips

25 Pcs.

Metropolitan Supply

10197PK

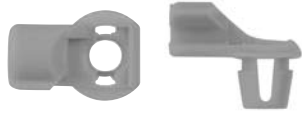

4mm Rod Size
Hole Size: 6.5mm
Left Hand Side
Blue Nylon
Door Rod End Clips

25 Pcs.

10196PK



4mm Rod Size
Hole Size: 6.5mm
Right Hand Side
Orange Nylon
Door Rod End Clips

25 Pcs.

10201PK

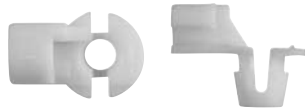

4.2mm Rod Size
Hole Size: 6.5mm
Left Hand Side
Natural Nylon
Door Rod End Clips

25 Pcs.

10200PK



4.2mm Rod Size
Hole Size: 6.5mm
Right Hand Side
Yellow Nylon
Door Rod End Clips

25 Pcs.

10109PK



5mm Rod Size
Hole Size: 7mm
Left Hand Side
Yellow Nylon
Door Rod End Clips

10 Pcs.

10110PK



5mm Rod Size
Hole Size: 7mm
Right Hand Side
Natural Nylon
Door Rod End Clips

10 Pcs.

Metropolitan Supply

10117PK



5mm Rod Size
Hole Size: 8.5mm
Left Hand Side
Yellow Nylon
Door Rod End Clips

10 Pcs.

10116PK



5mm Rod Size
Hole Size: 8.5mm
Right Hand Side
Natural Nylon
Door Rod End Clips

10 Pcs.

10120PK



5mm Rod Size
Hole Size: 8mm
Universal
Natural Nylon
Door Rod Clips

10 Pcs.

10203PK



8mm Rod Size
Square Hole Size: 7mm
O.A. Length: 30mm
Black Nylon
Hood Prop Rod Clips

10 Pcs.

9183PK



8mm Hole Size
Stem Length: 11mm
Bright Zinc Finish
Door Panel Clips

50 Pcs.

10700PK

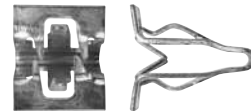

15/32" Width
11/16" Height
Bright Zinc Finish
Interior Trim, Garnish,
Bezel & Scuff Plate Fasteners

10 Pcs.

Metropolitan Supply

9900PK



5/16" Hole Size
Bright Zinc Finish
Trim Panel Fasteners
G.M. # 4114785
50 Pcs.

9876PK



For Thin Panels
Short Leg Type
Wire Type
Trim Panel Retainers
Ford # 351050-S3
100 Pcs.

9896PK

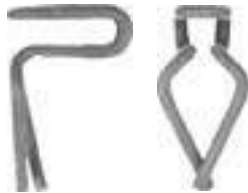

Short Leg Type
For Thin Panels
Wire Type
Trim Panel Retainers
100 Pcs.

578PK

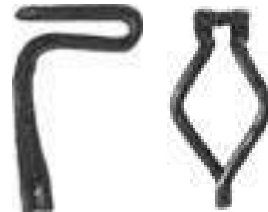

For Thin Panels
Wire Type
Trim Panel Retainers
Ford # 358470
100 Pcs.

579PK

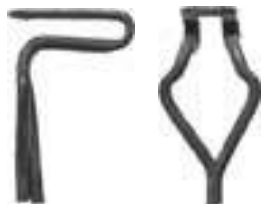

For Medium Panels
Wire Type
Trim Panel Retainers
100 Pcs.

577PK



For Thick Panels
Wire Type
Trim Panel Retainers
Ford # 383033-S101
100 Pcs.

10090PK

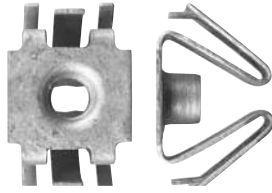

6-1.00mm Screw Size
Zinc Organic
Door Trim Panel
Retainer Nuts

10 Pcs.

10935PK



3/16" (5mm) Hole Size
Top Head Dia.: 11.5mm x 15mm
Stem Length: 14mm
White Nylon
Door Moulding Clips

25 Pcs.

9861PK



15/64" (6mm) Hole Size
Top Head Diameter: 18mm
Stem Length: 24mm
White Nylon
Trim Panel Retainers

50 Pcs.

9860PK



1/4" (6.4mm) Hole Size
Top Head Diameter: 11/16"
Stem Length: 9/16"
White Nylon
Door Trim Panel Retainers

50 Pcs

10399PK

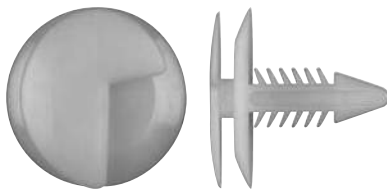

1/4" (6.3mm) Hole Size
Top Head Diameter: 15/16"
Stem Length: 3/4"
Natural Nylon
Door Trim Panel Retainers

50 Pcs.

1646PK



1/4" (6.5mm) Hole Size
Top Head Dia.: 6.3mm x 11.5mm
Stem Length: 21mm
Natural Nylon
Door Trim Panel Retainers

50 Pcs.

Metropolitan Supply

4020PK

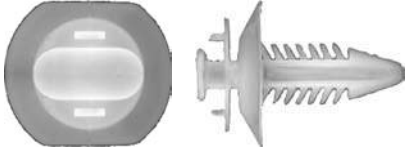

1/4" (6.5mm) Hole Size
Top Head Dia.: 6.3mm x 11.5mm
Stem Length: 21mm
Natural Nylon
Door Trim Panel Retainers

25 Pcs.

9242PK



1/4" (6.5mm) Hole Size
Top Head Diameter: 17mm
Stem Length: 21mm
Natural Nylon
Door Trim Panel Retainers

50 Pcs.

5264PK

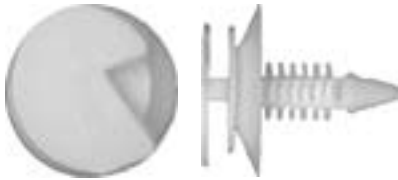

1/4" (6.5mm) Hole Size
Top Head Diameter: 29/32"
Stem Length: 29/32"
Natural Nylon
Door Trim Panel Retainers

50 Pcs.

2029PK



1/4" (6.3mm) Hole Size
Top Head Diameter: 37/64"
Stem Length: 11/16"
White Nylon
Push Type Door Trim Panel Ret.

50 Pcs.

9862PK



1/4" (6.5mm) Hole Size
Top Head Diameter: 18mm
Stem Length: 33mm
White Nylon
Door Trim Panel Retainers

25 Pcs.

592PK

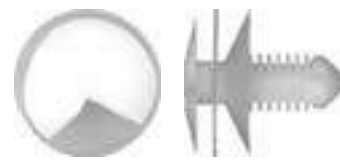

17/64" (7mm) Hole Size
Top Head Diameter: 17.6mm
Stem Length: 14.8mm
Natural Nylon
Door Trim Panel Retainers

50 Pcs.

10543PK

NEW!

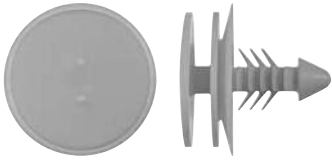

17/64" (7mm) Hole Size
Top Head Diameter: 18mm
Yellow Nylon
Door Garnish Moulding &
Pillar Trim Panel Retainers

25 Pcs.

2017PK

NEW!



17/64" (7mm) Hole Size
Top Head Diameter: 14mm
Stem Length: 16mm
Black Nylon
Door Trim Panel Retainers

50 Pcs.

1024PK



17/64" (7mm) Hole Size
Top Head Diameter: 20mm
Stem Length: 18.5mm
Natural Nylon
Door Trim Panel Retainers

25 Pcs.

9339PK

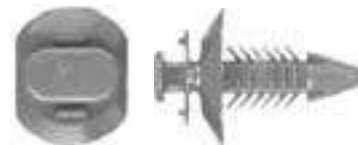

17/64" (7mm) Hole Size
Top Head Dia.: 7mm x 12.5mm
Stem Length: 19mm
White Nylon
Door Trim Panel Retainers

25 Pcs.

10403PK

NEW!



17/64" (7mm) Hole Size
Top Head Diameter: 19mm
Stem Length: 22mm
Black Nylon
Door Trim Panel Retainers

50 Pcs.

10398PK

NEW!

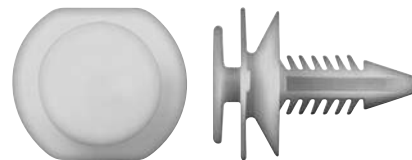

17/64" (7mm) Hole Size
Top Head Diameter: 16mm
Stem Length: 21mm
Yellow Nylon
Door Trim Panel Retainers

50 Pcs.

Metropolitan Supply

10653PK

NEW!

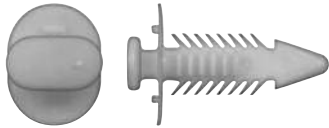

17/64" (7mm) Hole Size
Top Head Dia.: 7mm x 12.5mm
Stem Length: 20mm
Natural Nylon
Door Trim Panel Retainers

50 Pcs.

10520PK

NEW!

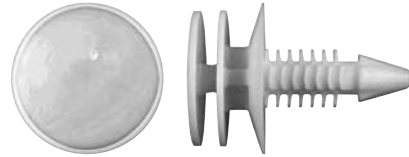

17/64" (7mm) Hole Size
Top Head Diameter: 18mm
Stem Length: 20.6mm
White Nylon
Door Panel Retainers

50 Pcs.

10495PK

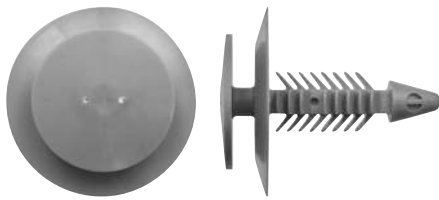

17/64" (7mm) Hole Size
Top Head Diameter: 18mm
Stem Length: 24mm
Green Nylon
Door Trim Panel Retainers

25 Pcs.

9224PK

NEW!



17/64" (7.1mm) Hole Size
Top Head Diameter: 13.2mm
Stem Length: 20mm
Natural Nylon
Door Trim Panel Retainers

50 Pcs.

1807PK

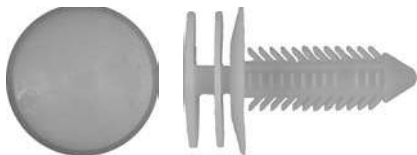

17/64" (7mm) Hole Size
Top Head Diameter: 18mm
Stem Length: 24mm
White Nylon
Door Trim Panel Retainers

25 Pcs.

1716PK

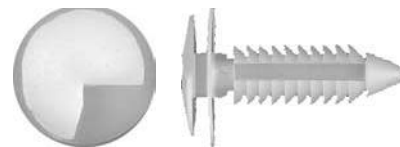

17/64" (7mm) Hole Size
Top Head Diameter: 17mm
Stem Length: 25mm
Natural Nylon
Door Trim Panel Retainers

100 Pcs.

Metropolitan Supply

9502PK



17/64" (7mm) Hole Size
Top Head Diameter: 22mm
Stem Length: 27mm
White Nylon
Door Trim Panel Retainers

25 Pcs.

9368PK

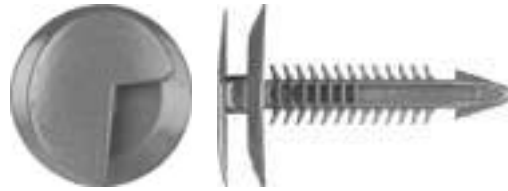

17/64" (7mm) Hole Size
Top Head Diameter: 20mm
Stem Length: 32mm
Natural Nylon
Door Trim Panel Retainers

50 Pcs.

10544PK



17/64" (7mm) Hole Size
Top Head Diameter: 15mm
Stem Length: 13mm
White Nylon
Door Trim Panel Retainers

25 Pcs.

9373PK



17/64" (7mm) Hole Size
Top Head Diameter: 13mm
Stem Length: 18mm
Black Nylon
Door Trim Panel Retainers

25 Pcs.

2112PK

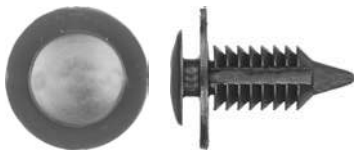

17/64" (7mm) Hole Size
Top Head Diameter: 12.5mm
Stem Length: 19mm
Black Nylon
Door Trim Panel Retainers

50 Pcs.

10719PK

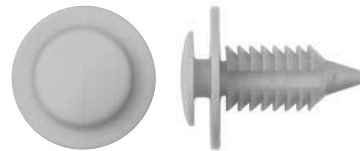

17/64" (7mm) Hole Size
Top Head Diameter: 12.5mm
Stem Length: 19mm
Yellow Nylon
Door Trim Panel Retainers

50 Pcs.

1558PK

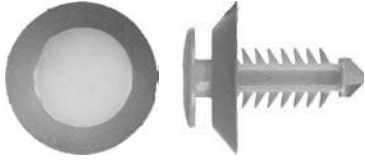

17/64" (7mm) Hole Size
Top Head Diameter: 13.3mm
Stem Length: 19mm
Natural Nylon
Door Trim Panel Retainers

25 Pcs.

9514PK

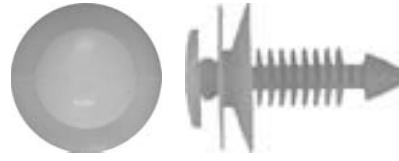

17/64" (7mm) Hole Size
Top Head Diameter: 13mm
Stem Length: 22mm
Natural Nylon
Door Trim Panel Retainers

50 Pcs.

1648PK



17/64" (7mm) Hole Size
Top Head Diameter: 20mm
Stem Length: 24mm
White Nylon
Door Panel Trim Retainers

25 Pcs.

9021PK



5/16" (8mm) Hole Size
Top Head Diameter: 13.15mm
Black Nylon
Back Seat
Door Trim Panel Retainers

25 Pcs.

1742PK

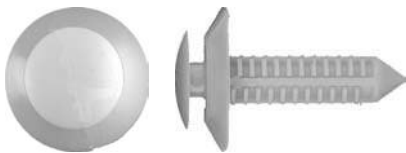

5/16" (8mm) Hole Size
Top Head Diameter: 1/2"
Stem Length: 1"
Natural Nylon
Door Trim Panel Retainers

50 Pcs.

10649PK



17/64" (7mm) Hole Size
Top Head Diameter: 15mm
Stem Length: 14.6mm
Yellow Nylon
Door Trim Panel Retainers

50 Pcs.

Metropolitan Supply

10576PK

NEW!



5/16" (8mm) Hole Size
Top Head Diameter: 12.8mm
Stem Length: 14mm
Orange Nylon With Sealer
Door Trim Panel Retainers

25 Pcs.

10671PK

NEW!



17/64" (7mm) Hole Size
Top Head Diameter: 15mm
Stem Length: 15mm
White Nylon
Door Trim Panel Retainers

25 Pcs.

2063PK

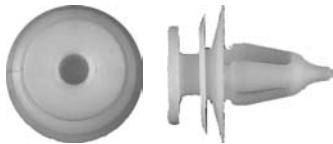

17/64" (7mm) Hole Size
Top Head Diameter: 13mm
Stem Length: 15mm
White Nylon
Door Trim Panel Retainers

50 Pcs.

9380PK



17/64" (7mm) Hole Size
Top Head Diameter: 15mm
Stem Length: 15mm
Green Nylon
Door Trim Panel Clips

50 Pc.

10703PK

NEW!



9/32" (7.4mm) Hole Size
Top Head Diameter: 17mm
Stem Length: 14mm
White Nylon
Door Trim Panel Retainers

50 Pcs.

9379PK

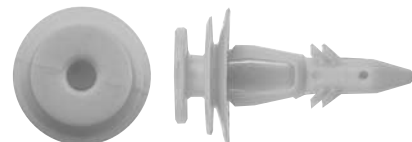

19/64" (7.5mm) Hole Size
Top Head Diameter: 13mm
Stem Length: 26mm
Yellow Nylon
Tail Gate & Trim Panel Retainers

25 Pcs.

10098PK

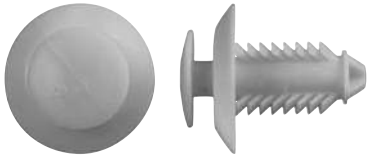

5/16" (7.9mm) Hole Size
Top Head Diameter: 1/2"
Stem Length: 3/4"
Yellow Nylon
Door Trim Panel Retainers

25 Pcs.

10947PK

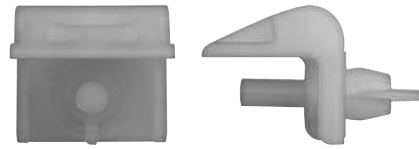

17/64" (7mm) Hole Size
Base Size: 19mm x 20.5mm
Stem Length: 6mm
Natural Nylon
Door Trim Panel Retainers

15 Pcs.

10932PK



19/64" (7.5mm) Hole Size
Top Head Diameter: 28mm
Stem Length: 11mm
Black Nylon
Door Trim Panel Retainers

25 Pcs.

1201PK



5/16" (8mm) Hole Size
Top Head Diameter: 12.6mm
Stem Length: 18mm
Black Nylon
Door Trim Panel Retainers

50 Pcs.

1575PK



5/16" (8mm) Hole Size
Top Head Diameter: 1/2"
Stem Length: 3/4"
Black Nylon
Door Trim Panel Retainers

25 Pcs.

9372PK



5/16" (8mm) Hole Size
Top Head Diameter: 1/2"
Stem Length: 21/32"
White Nylon
Door Trim Panel Retainers

50 Pcs.

Metropolitan Supply

10610PK



5/16" (8mm) Hole Size
Flange Diameter: 17mm
Stem Length: 12mm
Black Nylon
Door Panel Retainers

10 Pcs.

9444PK

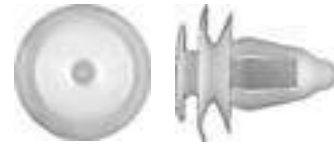

5/16" (8mm) Hole Size
Top Head Diameter: 13mm
Stem Length: 15mm
White Nylon
Door Trim Panel Retainers

25 Pcs.

10575PK



5/16" (8mm) Hole Size
Top Head Diameter: 15mm
Stem Length: 10mm
Black Nylon
Door Trim Panel Retainers

10 Pcs.

9539PK



5/16" (8mm) Hole Size
Top Head Diameter: 13mm
Stem Length: 17.5mm
Natural Nylon
Door Trim Panel Retainers

50 Pcs.

10924PK



5/16" (8mm) Hole Size
Top Head Diameter: 13.5mm
Stem Length: 14.5mm
Natural Nylon
Door Trim Panel Retainers

25 Pcs.

10945PK



5/16" (8mm) Hole Size
Top Head Diameter: 13.5mm
Stem Length: 14mm
Black Nylon
Door Trim Panel Retainers

25 Pcs.

Metropolitan Supply

10930PK

NEW!

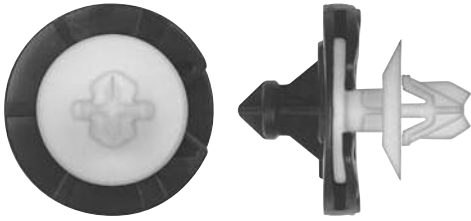

5/16" (8mm) Hole Size
Head Diameter: 28mm
Stem Length: 11mm
Natural & Black Nylon
Interior Trim Retainers

25 Pcs.

10884PK

NEW!

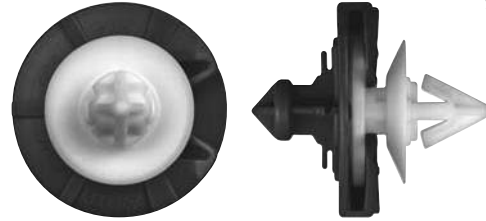

5/16" (8mm) Hole Size
Head Diameter: 28.5mm
Stem Length: 12.5mm
Double Ended White/Tan Nylon
Door Trim Panel Retainers

15 Pcs.

10933PK

NEW!



5/16" (8mm) Hole Size
Head: 28.3mm Stem: 12mm
Natural & Black Nylon
Double Ended
Interior Trim Retainers

25 Pcs.

10916PK

NEW!



5/16" (8mm) Hole Size
Top Head Diameter: 16mm
Stem Length: 10.5mm
Black Nylon With Sealer
Door Trim Panel Retainers

25 Pcs.

10920PK

NEW!



5/16" (8mm) Hole Size
Top Head Diameter: 22mm
Stem Length: 11mm
Black Nylon With Sealer
Door Trim Panel Retainers

25 Pcs.

10931PK

NEW!



5/16" (8mm) Hole Size
Top Head Diameter: 22mm
Stem Length: 12.5mm
Black Nylon
Trim Panel Retainers

25 Pcs.

Metropolitan Supply

10788PK

NEW!

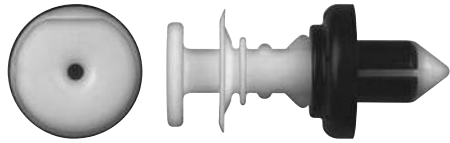

21/64" (8.3mm) Hole Size
Top Head Diameter: 15mm
Stem Length: 13mm
White and Black Nylon
Interior Trim Panel Retainers

15 Pcs.

10573PK

NEW!



11/32" (8.5mm) Hole Size
Top Head Diameter: 13mm
Stem Length: 13mm
Blue Nylon
Door Trim Panel Retainers

25 Pcs.

10724PK

NEW!

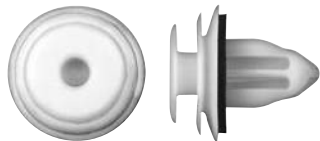

11/32" (8.5mm) Hole Size
Top Head Diameter: 13mm
Stem Length: 14mm
White Nylon With Sealer
Door Trim Panel Retainers

15 Pcs.

10687PK

NEW!



11/32" (8.5mm) Hole Size
Top Head Diameter: 13mm
Stem Length: 14mm
Turquoise Nylon
Door Trim Panel Retainers

25 Pcs.

10927PK

NEW!



11/32" (8.5mm) Hole Size
Top Head Diameter: 13mm
Stem Length: 16mm
Yellow Nylon
Interior Panel Trim Retainers

25 Pcs.

10751PK

NEW!

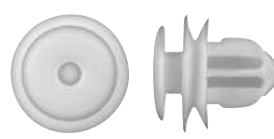

11/32" (8.75mm) Hole Size
Top Head Diameter: 13mm
Stem Length: 11mm
White Nylon
Garnish Moulding Retainers

25 Pcs.

10744PK



23/64" (8.8mm) Hole Size
Top Head Diameter: 13mm
Stem Length: 10mm
Natural Nylon
Trim Panel Retainers

25 Pcs.

10701PK

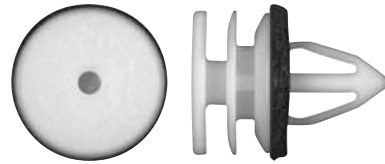

23/64" (9mm) Hole Size
Top Head Diameter: 19.5mm
Stem Length: 18mm
White Nylon With Sealer
Door Trim Panel Retainers

15 Pcs.

10470PK

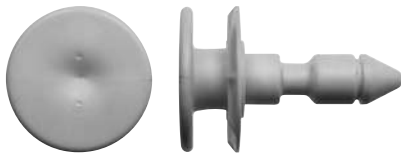

Top Head Diameter: 19.5mm
Stem Length: 30.4mm
Yellow Nylon
Door Panel Pins
Use with # 10478 & 10476

25 Pcs.

10471PK

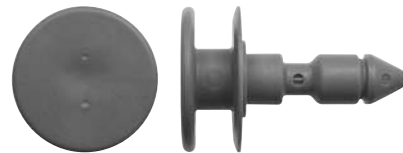

Top Head Diameter: 19.5mm
Stem Length: 30.4mm
Green Nylon
Door Panel Pins
Use with # 10478

25 Pcs.

10472PK



Top Head Diameter: 19.5mm
Stem Length: 28.3mm
Black Nylon
Door Panel Pins
Use with # 10476

25 Pcs.

10473PK



Top Head Diameter: 19.5mm
Stem Length: 28.3mm
White Nylon
Door Panel Pins
Use with # 10476

25 Pcs.

Metropolitan Supply

10474PK



Top Head Diameter: 13mm
Stem Length: 26.5mm
White Nylon
Door Panel Pins
Use with # 10476

25 Pcs.

10529

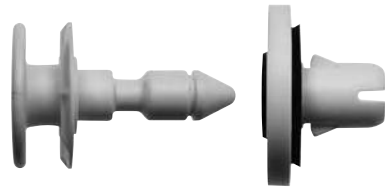

23/64" (9mm) Hole Size
Yellow Pin
Yellow Nut With Sealer
Two Part Nylon
Door Panel Retainers

15 Pcs.

10530

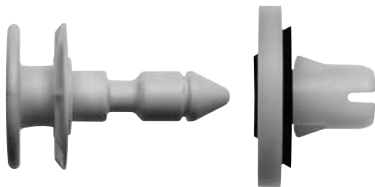

23/64" (9mm) Hole Size
Yellow Pin
White Nut With Sealer
Two Part Nylon
Door Panel Retainers

15 Pcs.

10531

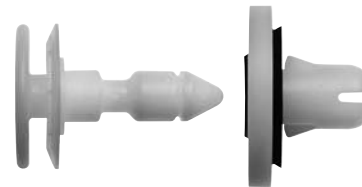

23/64" (9mm) Hole Size
White Pin
White Nut With Sealer
Two Part Nylon
Door Panel Retainers

15 Pcs.

10532

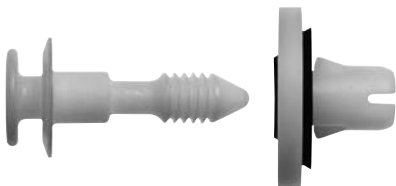

23/64" (9mm) Hole Size
White Pin
White Nut With Sealer
Two Part Nylon
Door Panel Retainers

25 Pcs.

10533



23/64" (9mm) Hole Size
Black Pin
White Nut With Sealer
Two Part Nylon
Door Panel Retainers

15 Pcs.

Metropolitan Supply

10534

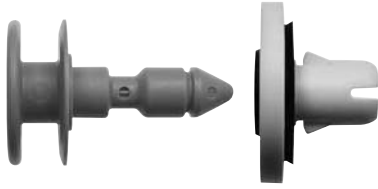

23/64" (9mm) Hole Size
Green Pin
Yellow Nut With Sealer
Two Part Nylon
Door Panel Retainers

15 Pcs.

10476PK

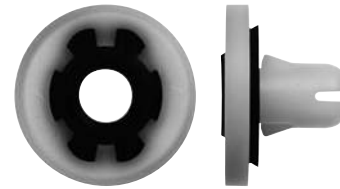

23/64" (9mm) Hole Size
White Nylon With Sealer
Door Panel Nuts
Use with # 10470, 10472,
10473 & 10474

25 Pcs.

10478PK



23/64" (9mm) Hole Size
Yellow Nylon With Sealer
Door Panel Nuts
Use with # 10470 & 10471

25 Pcs.

10466PK

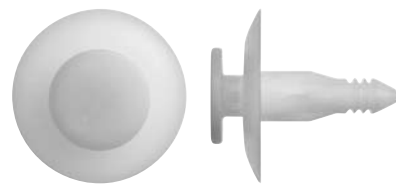

Top Head Diameter: 13mm
Flange Diameter: 23mm
White Nylon
Door Panel Retainers
Use With # 10467
25 Pcs.

10467PK

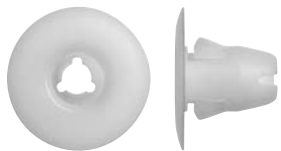

23/64" (9mm) Hole Size
Head Diameter: 19mm
White Nylon
Door Panel Nuts
Use With # 10466

25 Pcs.

2144PK



23/64" (9mm) Hole Size
Top Head Diameter: 12.6mm
Stem Length: 14mm
White Nylon
Door Trim Panel Retainers

15 Pcs.

Metropolitan Supply

2145PK

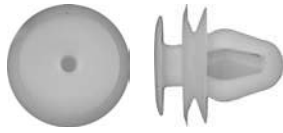

23/64" (9mm) Hole Size
Top Head Diameter : 13mm
Stem Length: 11mm
Natural Nylon
Door Trim & Garnish Retainers

25 Pcs.

10612PK



23/64" (9mm) Hole Size
Top Head Diameter: 16mm
Stem Length: 17mm
White Nylon With Sealer
Door Trim Panel Retainers

25 Pcs.

10494PK



23/64" (9mm) Hole Size
Top Head Diameter: 16mm
Stem Length: 15.4mm
White Nylon
Door Trim Panel Retainers

15 Pcs.

10774PK



23/64" (9mm) Hole Size
Top Head Diameter: 15mm
Stem Length: 12mm
Neon Pink Nylon
Door Trim Panel Retainers

25 Pcs.

10773PK



23/64" (9mm) Hole Size
Top Head Diameter: 13mm
Stem Length: 13mm
Gray Nylon
Trim Panel Retainers

25 Pcs.

10405PK



23/64" (9mm) Hole Size
Top Head Diameter: 14mm
Stem Length: 14mm
White Nylon
Door Trim Panel Retainers

25 Pcs.

10748PK



23/64" (9mm) Hole Size
Top Head Dia: 13mm Stem: 13mm
White Nylon
Door Panel &
Rocker Moulding Retainers

15 Pcs.

9081PK



23/64" (9mm) Hole Size
Top Head Diameter: 13mm
Stem Length: 14mm
White Nylon
Door Trim Panel Retainers

25 Pcs.

1588PK



23/64" (9mm) Hole Size
Top Head Diameter: 13mm
Stem Length: 14mm
Black Nylon
Door Trim Panel Retainers

25 Pcs.

10939PK



23/64" (9mm) Hole Size
Top Head Diameter: 12mm
Stem Length: 11mm
White Nylon
Fender Moulding Trim Retainers

25 Pcs.

10464PK



3/8" (9.5mm) Hole Size
Top Head Diameter: 15mm
Stem Length: 14mm
Yellow & White Nylon
Door Trim Panel Retainers

25 Pcs.

2108PK



3/8" (9.5mm) Hole Size
Top Head Diameter: 15mm
Stem Length: 14mm
White Nylon
Door Trim Panel Retainers

25 Pcs.

Metropolitan Supply

10463PK

NEW!



3/8" (9.5mm) Hole Size
Top Head Diameter: 15mm
Stem Length: 16.8mm
Green & White Nylon
Door Trim Panel Retainers

25 Pcs.

10465PK



3/8" (9.5mm) Hole Size
Top Head Diameter: 15mm
Stem Length: 18mm
Gray & White Nylon
Door Trim Panel Retainers

25 Pcs.

10667PK

NEW!

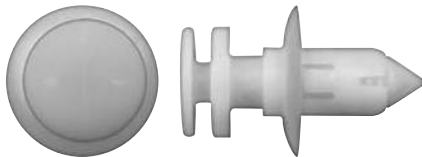

25/64" (10mm) Hole Size
Top Head Diameter: 15mm
Stem Length: 19.5mm
Natural Nylon
Door Trim Panel Retainers

25 Pcs.

10952PK

NEW!



25/64" (10mm) Hole Size
Head Diameter: 22mm
Stem Length: 10mm
Black Nylon
Door Trim Panel Retainers

25 pcs.

10917PK

NEW!

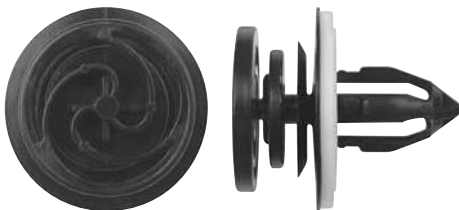

25/64" (10mm) Hole Size
Top Head Diameter: 21.5mm
Stem Length: 19mm
Black Nylon With Sealer
Door Trim Panel Retainers

25 Pcs

10749PK

NEW!



7/16" (11.1mm) Hole Size
Top Head Diameter: 14mm
Stem Length: 14mm
White Nylon With Sealer
Door Trim Panel Retainers

10 Pcs.

10581

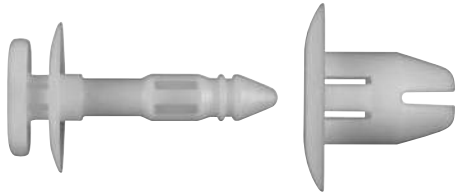

15/32" (12mm) Hole Size
Window Lift Motor Mounting
Natural Nylon
Drive Type Rivet
Pin & Grommet Kit
Chrysler
25 Pcs.

10584



15/32" (12mm) Hole Size
Window Lift Motor Mounting
Natural Nylon
Drive Type Rivet
Pin & Grommet Kit
Chrysler
25 Pcs.

10477PK

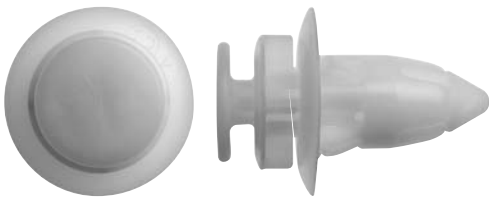

1/2" (12.7mm) Hole Size
Top Head Diameter: 16mm
Stem Length: 25mm
Natural Nylon
Door Panel Retainers
Chrysler
25 Pcs.

10582PK



1/4" (6.2mm) Hole Size
Window Lift Motor Mounting
Natural Nylon
Drive Type Rivet Pins
Used with # 10583
Chrysler
25 Pcs.

10583PK

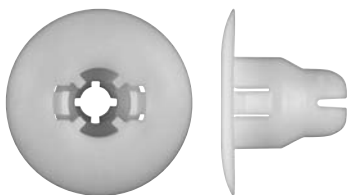

1/2" (12.7mm) Hole Size
Window Lift Motor Mounting
Natural Nylon
Drive Type Rivet Grommets
Used with # 10582
Chrysler
25 Pcs.

10579PK

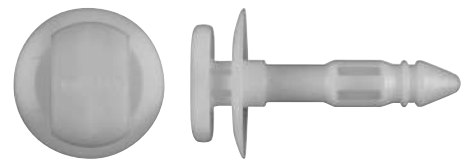

(1/4") 6.3mm Hole Size
Window Lift Motor Mounting
Natural Nylon
Drive Type Rivet Pins
Used with # 10580
Chrysler
25 Pcs.

10580PK

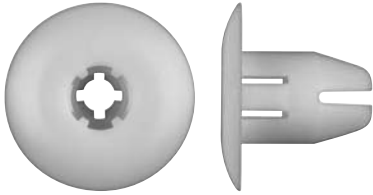

1/2" (12.7mm) Hole Size
Window Lift Motor Mounting
Natural Nylon
Drive Type Rivet Grommets
Used with # 10579
Chrysler
25 Pcs.

4011PK



Some Installations
may require
5/8" Washer
(Some provided)

Remove & Resetting Door Glass
Made Easy, Fits Most:
Ford, G.M., Chry. Products
Black Zytel Nylon
Door Glass Replacement Kits
50 Pcs.

10479PK

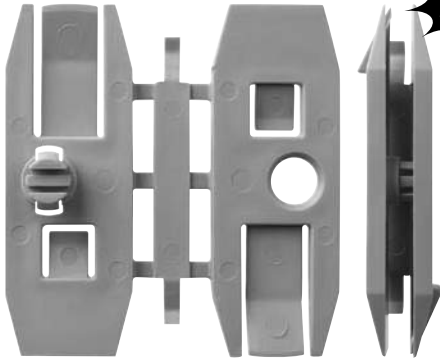

Photo Not Actual Size
Assembled Over All Size 1" x 2 3/8"
Gray Nylon Front Door Window Guides
G.M. # 15786626
10 Pcs.

1566PK



Rear of Glass
Black Nylon
Front Door Glass
Window Guide Retainers
G.M. # 22539533
15 Pcs.

1563PK



Upper Part of Glass
Black Nylon
Front Door Glass
Window Guide Retainers
G.M. # 20160591
25 Pcs.

1568PK



Black Nylon
Front Door Glass
Window Guide Retainers
G.M. # 20162174
25 Pcs.

Metropolitan Supply

1681PK



2 3/4" X 1 3/4" Over All Size
Black Nylon
Front Door Glass
Window Guide Retainers
G.M. # 12337898
15 Pcs.

1562PK



Black Nylon
Front & Rear Door Glass
Window Guide Retainers
G.M. # 20328600
25 Pcs.

9421PK



2 3/4" x 1 3/4" Over All Size
Front of Glass 4mm Thick
Black Nylon
Front Door Glass
Window Guide Retainers
G.M. # 20712176
15 Pcs.

1570PK



Includes Rivets
Window Guide Retainers
Chrysler # 4339372
25 Pcs.

9635PK



1 5/16" Height
6" Over All Length
Black Plastic
Front Door Glass
Window Guides Retainers
G.M. # 20180140
25 Pcs.

Metropolitan Supply

10107



Contains 1 Gear # 10108 & 3 Pins # 9392
Window Lift Motor Gear Kit
1 Kit

9233PK



1/64" Thick
21/64" I.D. 9/16" O.D.
Stainless Steel
Door Hinge Pin Retainers
(Use with # 9164PK)
G.M. # 15562610
50 Pcs.

1269PK

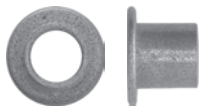

.269" I.D.
.316" O.D.
.356" Height
Door Hinge Pin Bushings
Chrysler # 4033711
25 Pcs.

1267PK



.345" I.D.
.419" O.D.
.295" Height
Door Hinge Pin Bushings
G.M. # 9721917
25 Pcs.

Metropolitan Supply

9805PK



.387" I.D.
.472" O.D.
.262" Height
Door Hinge Pin Bushings
1 Pc.

1270PK



.348" I.D.
.479" O.D.
.296" Height
Door Hinge Pin Bushings
Ford # D90Z-6522841A
25 Pcs.

9965PK



.374" I.D.
.495" O.D.
.322" Height
Door Hinge Pin Bushings
1 Pc.

1251PK



.384" I.D.
.501" O.D.
.460" Height
Door Hinge Pin Bushings
G.M. # 9822198
25 Pcs.

1252PK



.346" I.D.
.490" O.D.
.375" Height
Door Hinge Pin Bushings
G.M. # 9716926
25 Pcs.

2115PK



.385" I.D.
.530" O.D.
.365" Height
Door Hinge Pin Bushings
G.M. # 15562609
25 Pcs.

Metropolitan Supply

1268PK



.345" I.D.
.489" O.D.
.362" Height
Door Hinge Pin Bushings
G.M. # 20429500
25 Pcs.

2114PK



.345" I.D.
.495" O.D.
.365" Height
Door Hinge Pin Bushings
G.M. # 12338074
25 Pcs.

10061PK



(Yellow Zinc Finish)

O.A. Length: 2"
Thread Pitch: 5/16" - 24
Long Type
Door Hinge Pin
1 Pc.

10062PK



(Yellow Zinc Finish)

O.A. Length: 1 7/8"
Thread Pitch: 5/16" - 24
Short Type
Door Hinge Pin
1 Pc.

1289PK



(Black Zinc Finish)

11/32" Pin Diameter
Length: 4"
Head O.D.: 7/16"
Door Hinge Pins
G.M. # 20043351
10 Pcs.

1288PK

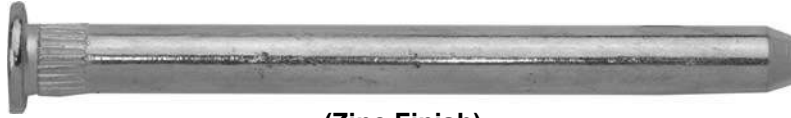

(Zinc Finish)

11/32" Pin Diameter
Length: 4 1/16"
Head O.D. : 9/16"
Door Hinge Pins
G.M. # 6271989
10 Pcs.

9825PK

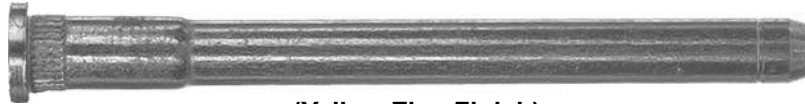

(Yellow Zinc Finish)

11/32" Pin Diameter
Length: 4 1/8"
Head O.D. : 1/2"
Door Hinge Pins
G.M. # 15653790
2 Pcs.

9164PK



(Stainless Steel)

11/32" Pin Diameter
5 1/4" Length
Stainless Steel
Door Hinge Pins
G.M. # 15591860
5 Pcs.

10451PK



(Zinc Finish)

1 1/32" Pin Diameter
5 1/4" Length
Yellow Zinc Finish Steel
Door Hinge Pins
5 Pcs.

2168PK



(Zinc Finish)

9/16" Pin Diameter
Length: 5 1/2"
Roller Groove Dia. : 5/8"
Kurl Dia. : 19/32"
Door Roller Pin Assembly
G.M. # 12540326
1 Pc.

9595PK



(Zinc Finish)

1 1/32" Pin Diameter
Length: 3 3/8"
Head O.D. : 9/16"
Door Hinge Pins
Ford # D9ZZ-6643030-AA
10 Pcs.

9937PK



(Zinc Finish)

11/32" Pin Diameter
Length: 3 1/2"
Head O.D.: 9/16"
Ford Ranger, F150, F250 & F350
Door Hinge Pins
Ford # E8UZ1522840
5 Pcs.

1292PK



(Black Finish)

17/64" Pin Diameter
Length: 2 3/4"
Head O.D. : 9/16"
Door Hinge Pins
Chrysler # 6028993
10 Pcs.

9832

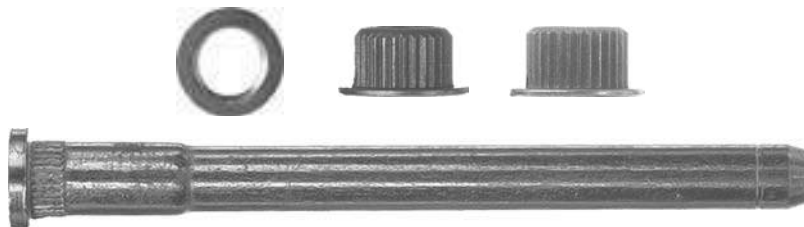

(Yellow Zinc Finish Pin)

G.M. S10 Trucks
1994 - On
Kit Will Repair One Hinge
Door Hinge Pin and Bushing Kit
1 Kit

9833

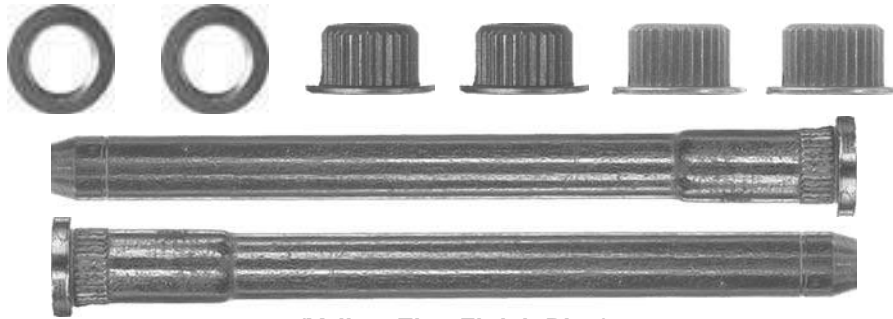

(Yellow Zinc Finish Pins)

G.M. S10 Trucks
1994 - On
Kit Will Repair One Door
Door Hinge Pin and Bushing Kit
1 Kit

9818

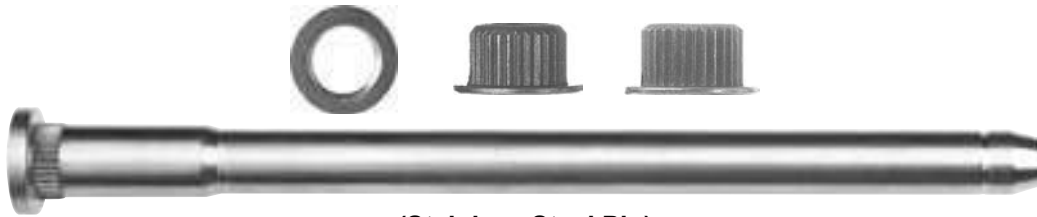

(Stainless Steel Pin)

G.M. Trucks C-K
1988 - On
Kit Will Repair One Hinge
Door Hinge Pin and Bushing Kit
1 Kit

10528

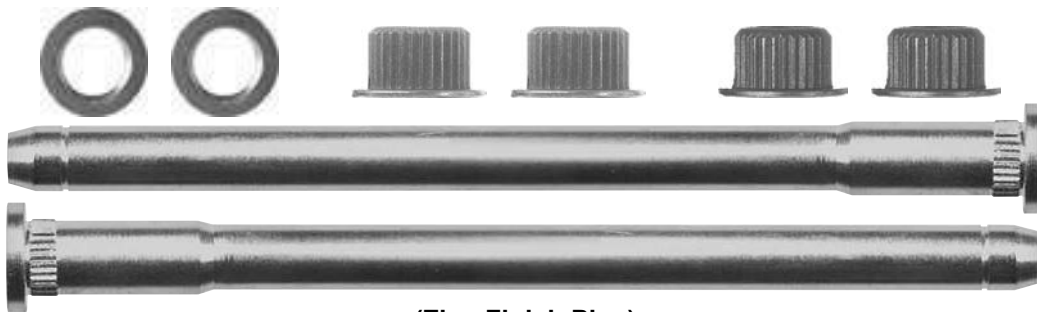

(Zinc Finish Pins)

G.M. Trucks C-K 1988 - On
Kit Will Repair One Door
Door Hinge Pin & Bushing Kit
1 Kit



9905

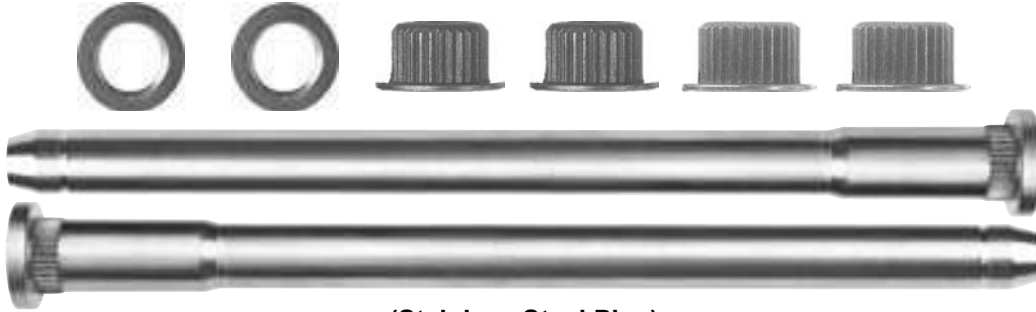

(Stainless Steel Pins)

G.M. Trucks C-K
1988 - On
Kit Will Repair One Door
Door Hinge Pin and Bushing Kit
1 Kit

10527

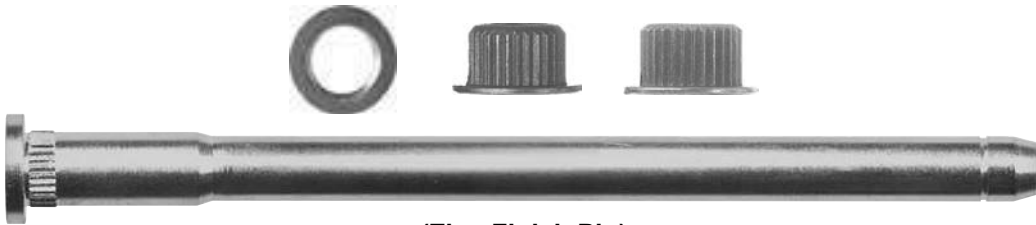

(Zinc Finish Pin)

G.M. Trucks C-K
1988 - On
Kit Will Repair One Hinge
Door Hinge Pin and Bushing Kit
1 Kit

10060



(Yellow Zinc Finish Pins)

Replacement Parts To Replace One Hinge
GMC Sierra & Chev. Silverado & Other S.U.V.'s Hinges
Door Hinge Pin & Bushing Kit
1 Kit

10065

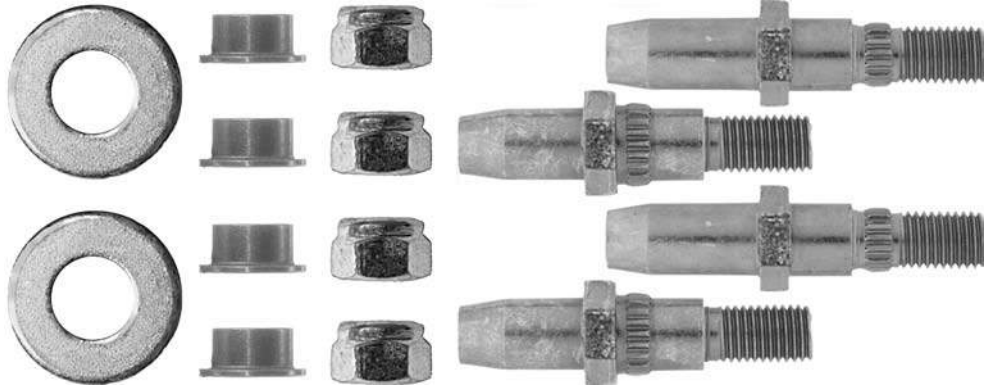

Replacement Parts To Replace One Door
GMC Sierra & Chev. Silverado & Other S.U.V.'s Hinges
Door Hinge Pin & Bushing Kit
1 Kit

9948

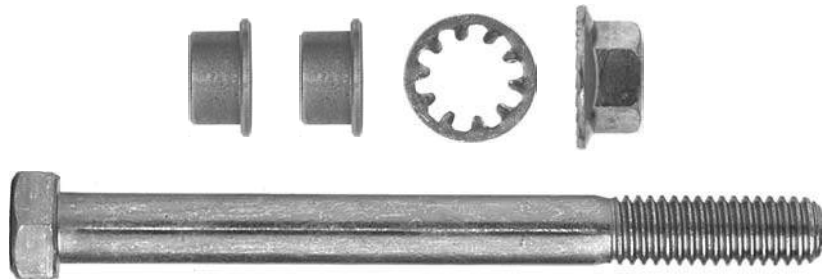

Dodge Trucks
1994 - 2003 Dodge Ram
Kit will Repair One Hinge
Door Hinge Pin & Bushing Kit
1 Kit

9964

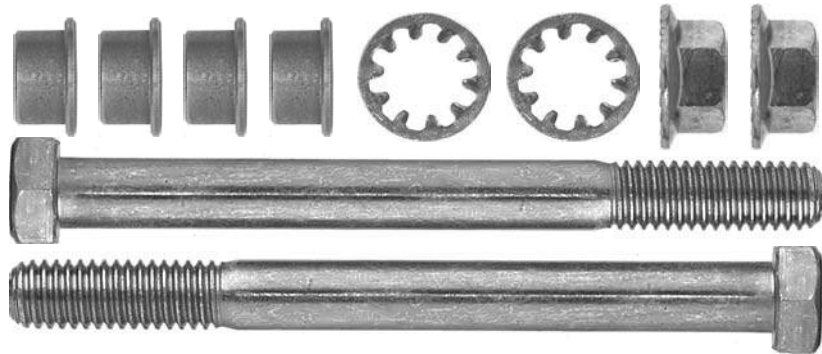

Dodge Trucks
1994-2003 Dodge Ram
Kit Will Repair One Door
Door Hinge Pin & Bushing Kit
1 Kit

9939

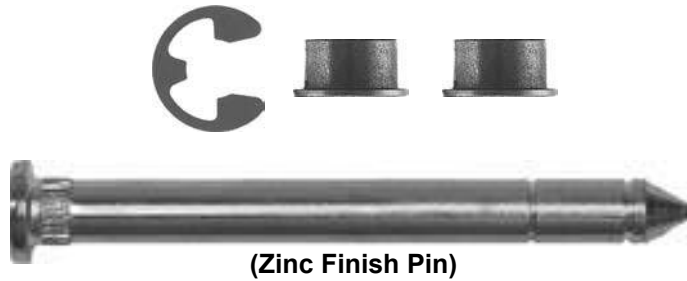

Ford F - Series 1980 - 98
Kit Will Repair One Hinge
Door Hinge Pin and Bushing Kit
1 Kit

9940

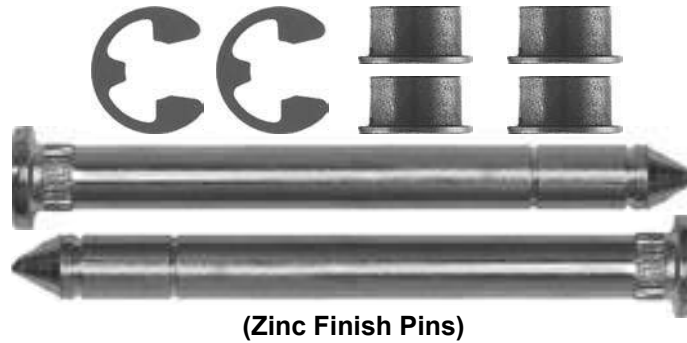

Ford F - Series 1980 - 98
Kit Will Repair One Door
Door Hinge Pin and Bushing Kit
1 Kit

9906

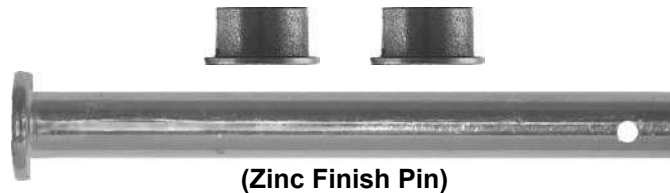

Topaz & Tempo 1990 - 94
Mustang 1979 - 93, Capri 1980 - 86
Kit Will Repair One Hinge
Door Hinge Pin and Bushing Kit
1 Kit

10558



Side Cargo Door
Greaseable Stainless Steel Door Hinge Pin & Bushing Kit
Chev. Savana & G.M.C. Express Van Side Doors
Repairs One Hinge
1 Kit

10699



Side Cargo Door
Greaseable Stainless Steel Door Hinge Pin & Bushing Kit
Chev. Savana & G.M.C. Express Van Side Doors
Repairs One Door
1 Kit

10559



Side Cargo Door Replacement Hinge
Chev. Savana & G.M.C. Express Van Side Doors
Use with # 10699
Sold Each



Headlight Fasteners

Metropolitan Supply

996PK



1/4-28 x 2" Screw
Bright Zinc Finish
Headlight Adjusting Screws

25 Pcs.

656PK

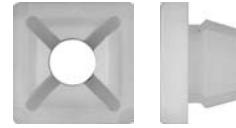

1/4-28 Screw Size
Black Nylon
Headlight Adjusting Nuts

50 Pcs.

972PK



1/4-28 x 2" Screw
White Nylon Nut
Headlight Adjusting
Screw & Nut Assembly

10 Pcs.

1003PK

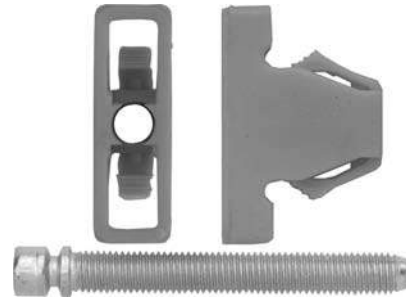

12-28 x 2" Screw
Blue Nylon Nut
Headlight Adjusting
Screw & Nut Assembly

25 Pcs.

1019PK



1/4-28 x 2" Screw
Green Nylon Nut
Headlight Adjusting
Screw & Nut Assembly

25 Pcs.

681PK



12-28 x 2" Screw
White Nylon Nut
Headlight Adjusting
Screw & Nut Assembly

10 Pcs.

Metropolitan Supply

853PK



1/4-28 x 2" Screw
Pink Nylon Nut
Headlight Adjusting
Screw & Nut Assembly

25 Pcs.

1107PK



8 Screw Size
Headlight Panel
Retainers
G.M. # 25501771
50 Pcs.

10106PK



1 1/8" Wide
4 9/16" Long
Natural Nylon
Headlight Retainers
G.M. # 10298115
10 Pcs.

1864PK



Headlight Component
Retaining Clips
Ford # E9DB-13N020AA
25 Pcs.

9720PK



Rear Light
Assembly Retainers
Ford # N806624-S191
25 Pcs.

9199PK



#8 Screw Size
Black Finish
Radiator Grille Nuts
G.M. # 15686142
25 Pcs.

Metropolitan Supply

9082PK



13mm Wide
22 mm Long
Grille Clips
Isuzu # 8942180270
25 Pcs.

1932PK



Radiator
Grille Clips
Toyota # 90467-17004
10 Pcs.

1436PK



13mm Wide
23mm Long
Grille Clips
Toyota # 90467-13005
25 Pcs.

10633PK



5/8" Width 1" Length
5/8" Overall Height
Black Finish
Radiator Grille &
Bumper Cover Fasteners
G.M. # 15078238
15 Pcs.

1585PK



Bright Zinc Finish
Front Bumper
Cushion Clips
Toyota # 90183-03001
25 Pcs.

1584PK

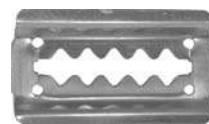

Bright Zinc Finish
Bumper Strip
Retainers
Toyota # 90468-04030
25 Pcs.

Metropolitan Supply

9809PK

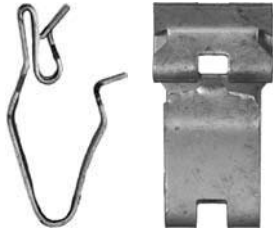

Zinc Plated
Radiator
Grille Retainers
G.M. # 15002520
25 Pcs.

10969PK



6-1.0mm Thread
Hole Size: 12mm x 20mm
Material Thickness: .7mm to 1.8mm
Zinc Organic
Headlight Mounting Clips
Ford # W710793-S439
10 Pcs.

10778PK

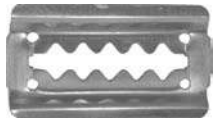

Width: 13mm
Length: 30mm
Stainless Steel
Bumper & Grille Retainers
Hyundai #86593-2400
25 Pcs.



Miscellaneous

Metropolitan Supply

1026PK



Width: 23/64"
Length: 13/16"
White Nylon
Vinyl Top Moulding Clips

50 Pcs.

1159PK



Width: 7/16"
Length: 31/32"
White Nylon
Quarter Belt
Reveal Moulding Clips

50 Pcs.

9853PK



Width: 7/16"
Length: 25/32"
Natural Nylon
Quarter Panel and Reveal
Moulding Clips

100 Pcs.

987PK



Width: 33/64"
Length: 27/32"
Gray Nylon
Body Side Moulding Clips

100 Pcs.

9895PK



Width: 31/64"
Length: 57/64"
White Nylon
Door, Quarter Panel & Rear End
Moulding Clips

50 Pcs.

1172PK



Width: 9/16"
Length: 61/64"
White Nylon
Quarter Belt
Reveal Moulding Clips

50 Pcs.

Metropolitan Supply

10950PK



Width: 10.2mm
Length: 32.5mm
White Nylon
Windshield Reveal
Moulding Clips

15 Pcs.

10545PK



6mm x 16mm Hole Size
Width: 11mm Length: 14mm
White Nylon
Front & Rear Bumper
Moulding Clips

25 Pcs.

10804PK



15/64" (6mm) Hole Size
Width: 12.5mm Length: 28mm
Yellow Nylon With Sealer
Side Window Reveal
Moulding Clips

10 Pcs.

10679PK

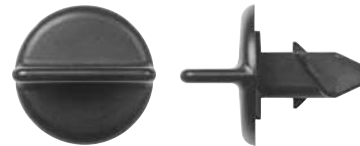

6.5mm x 12.5mm Hole Size
Black Nylon
Fascia Trim Cover
Twist Lock Retainers
For Escalade, Yukon, Suburban

25 Pcs.

10802PK



17/64" (7mm) Hole Size
Top Head Dia.: 7.5mm x 11mm
Stem Length: 13mm
Green Nylon With Sealer
Fender Moulding Clips

10 Pcs.

10823PK



17/64" (7mm) Hole Size
Width: 13mm Length: 30mm
Stem Length: 13mm
White Nylon With Sealer
Roof Rail Moulding Clips

15 Pcs.

Metropolitan Supply

10803PK

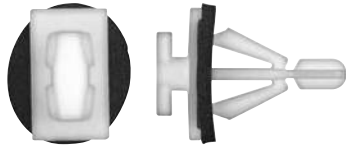

5/16" (8mm) Hole Size
Top Head Dia.: 6mm x 11mm
Stem Length: 20mm
White Nylon With Sealer
Side Window Moulding Clips

10 pcs.

10805PK

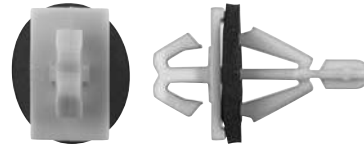

5/16" (8mm) Hole Size
Top Head Dia.: 10mm x 17mm
Stem Length: 20mm
Green Nylon With Sealer
Window Reveal Moulding Clips

5 Pcs.

9969PK

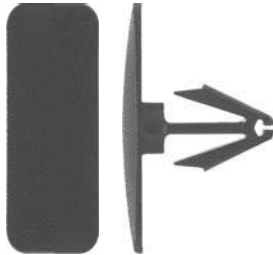

5/16" (8mm) Hole Size
Head Dia.: 15/32" x 1 5/16"
Stem Length: 11/16"
Black Nylon
Rocker Panel Moulding Clips

10 Pcs.

9967PK

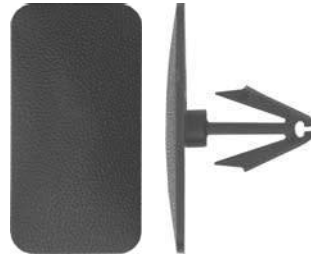

5/16" (8mm) Hole Size
Head Dia.: 11/16" x 1 5/16"
Stem Length: 11/16"
Black Nylon
Rocker Panel Moulding Clips

15 Pcs.

10489PK

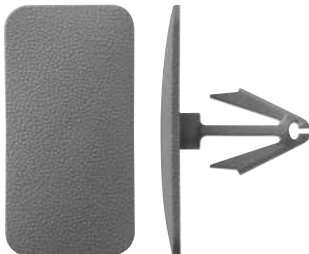

5/16" (8mm) Hole Size
Head Dia.: 11/16" x 1 5/16"
Stem Length: 11/16"
Gray Nylon
Rocker Panel Moulding Clips

15 Pcs.

10488PK

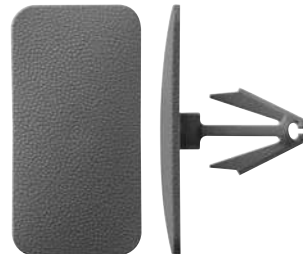

5/16" (8mm) Hole Size
Head Dia.: 11/16" x 1 5/16"
Stem Length: 11/16"
Tan Nylon
Rocker Panel Moulding Clips

15 Pcs.

Metropolitan Supply

10487PK

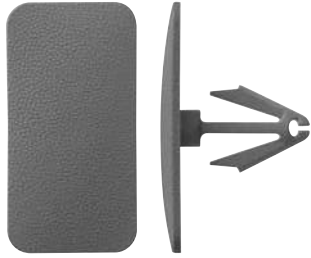

5/16" (8mm) Hole Size
Head Dia.: 11/16" x 1 5/16"
Stem Length: 11/16"
Red Nylon
Rocker Panel Moulding Clips

15 Pcs.

10484PK

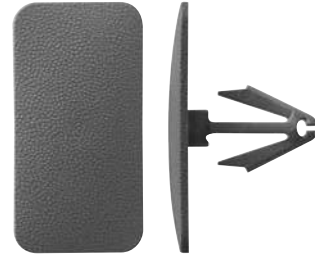

5/16" (8mm) Hole Size
Head Dia.: 11/16" x 1 5/16"
Stem Length: 11/16"
Dark Red Nylon
Rocker Panel Moulding Clips

15 Pcs.

9915PK

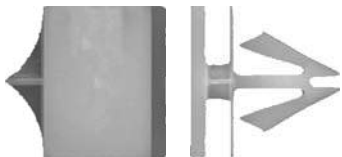

7/16" (11mm) Hole Size
Top Head Dia.: 9/16" x 3/16"
Stem Length: 9/16"
White Nylon
Rocker Panel Moulding Clips

15 Pcs.

9914PK



7/16" (11mm) Hole Size
Top Head Dia.: 15/32" x 13/16"
Stem Length: 9/16"
Green Nylon
Rocker Panel Moulding Clips

15 Pcs.

10480PK

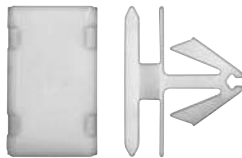

23/64" (9mm) Hole Size
Top Head Dia.: 12mm x 20mm
Stem Length: 11mm
White Nylon
Body Side Moulding Clips

15 Pcs.

10127PK

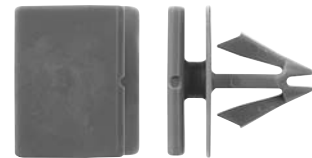

7/16" (11mm) Hole Size
Top Head Dia.: 9/16" x 3/4"
Stem Length: 9/16"
Gray Nylon
Rocker Panel Moulding Clips

25 Pcs.

Metropolitan Supply

10129PK

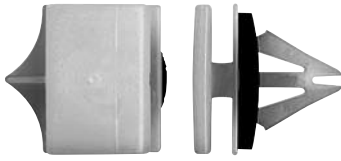

7/16" (11mm) Hole Size
Top Head Dia.: 9/16" x 13/16"
Stem Length: 9/16"
Natural Nylon With Sealer
Rocker Panel Moulding Clips

15 Pcs.

9990PK



7/16" (11mm) Hole Size
Top Head Dia.: 19/32" x 25/32"
Stem Length: 9/16"
Yellow Nylon With Sealer
Rear Wheel Opening Mldg. Clips

15 Pcs.

9991PK



7/16" (11mm) Hole Size
Top Head Dia.: 15/32" x 25/32"
Stem Length: 9/16"
Natural Nylon With Sealer
Rear Wheel Opening Mldg. Clips

10 Pcs.

9992PK



7/16" (11mm) Hole Size
Top Head Dia.: 9/16" x 13/16"
Stem Length: 9/16"
Black Nylon
Front Fender W/Opening Mldg. Clips

25 Pcs.

10481PK

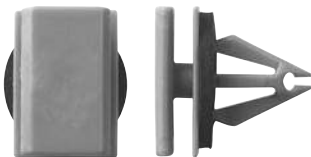

23/64" (9mm) Hole Size
Top Head Dia.: 12mm x 20mm
Stem Length: 15mm
Gray Nylon With Sealer
Windshield Pillar Mldg. Clips

15 Pcs.

10485PK



23/64" (9mm) Hole Size
Top Head Dia.: 14mm x 20mm
Stem Length: 14mm
Yellow Nylon With Sealer
Rocker Panel Moulding Clips

10 Pcs.

Metropolitan Supply

10357PK

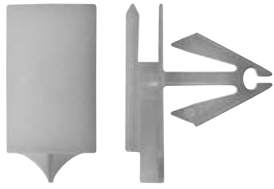

23/64" (9mm) Hole Size
Top Head Dia.: 12mm x 20mm
Stem Length: 14mm
White Nylon
Rocker Panel Moulding Clips

15 Pcs.

10680PK

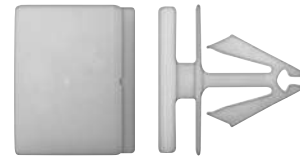

3/8" (9.5mm) Hole Size
Top Head Dia.: 9/16" x 13/16"
Stem Length: 9/16"
White Nylon
Rocker & Grille Moulding Clips

15 Pcs.

10482PK

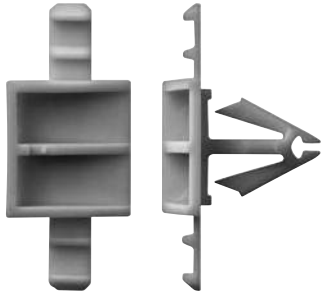

25/64" (10mm) Hole Size
Top Head Dia.: 16mm x 38mm
Stem Length: 15mm
Green Nylon
Body Side Moulding Clips

15 Pcs.

10827PK

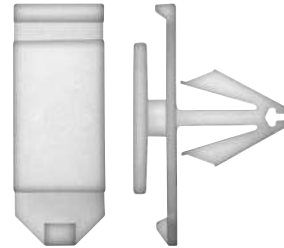

25/64" (10mm) Hole Size
Top Hd Dia.: 12mm x 20mm
Stem Length: 15mm
White Nylon
Rocker Moulding Clips

15 Pcs.

10056PK

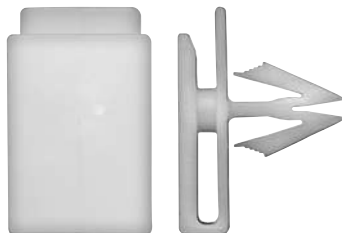

7/16" (11mm) Hole Size
Top Head Dia.: 3/4" x 1"
Stem Length: 19/32"
White Nylon
Rocker Panel Moulding Clips

15 Pcs.

10429PK

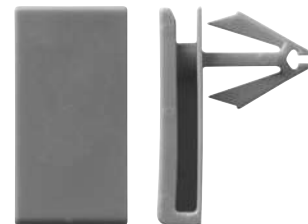

17/64" (7mm) Hole Size
Top Head Size: 9/16" x 1 1/8"
Stem Length: 9/16"
Grey Nylon
Rocker Panel Moulding Clips

15 Pcs.

10058PK

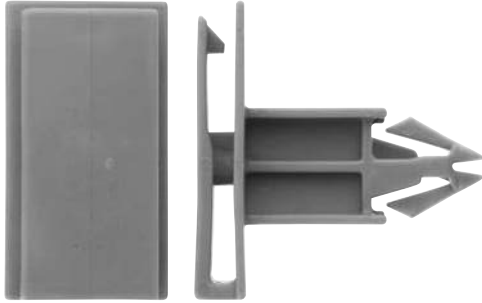

7/16" (11mm) Hole Size
 Top Head Dia.: 11/16" x 1 1/2"
 Stem Length: 1 1/4"
 Gray Nylon
 Rocker Panel Moulding Clips

15 Pcs.

10059PK

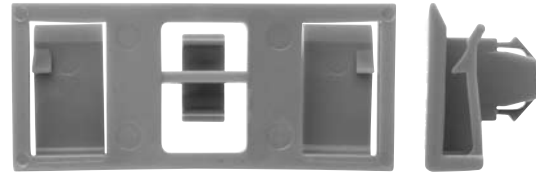

7/16" (11mm) Hole Size
 Width: 7/8" Length: 2"
 Stem Length: 17/32"
 Gray Nylon
 Rocker Panel Moulding Clips

10 Pcs.

10128PK

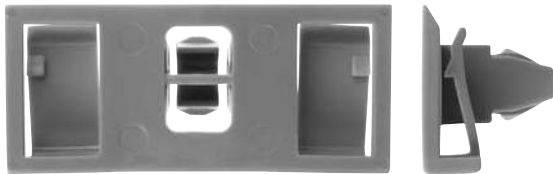

7/16" (11mm) Hole Size
 Width: 7/8" Length: 2"
 Stem Length: 21/32"
 Gray Nylon
 Rocker Panel Moulding Clips

10 Pcs.

10651PK

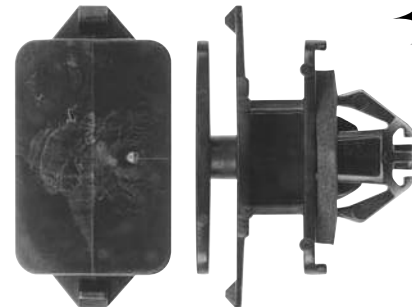

17mm Hole Size
 Top Head Dia.: 20mm x 30mm
 Overall Length: 28mm
 Black Nylon With Sealer
 Rocker Panel Moulding Clips

10 Pcs.

10629PK



Head Dia.: 11mm x 16mm
 Overall Length: 19mm
 Black Nylon
 Rocker Panel Moulding Clips
 Ford # 6G1Z-5410182-D
 25 Pcs.



10691PK



42mm From Tip to Tip
 Front To Back: 12mm
 Height: 21mm
 Roof & Garnish
 Moulding Clips
 Ford # 4L3Z-1510182-AA
 15 Pcs.



10913PK



5/16" (8mm) Hole Size
Top Head Dia.: 14mm x 18mm
Stem Length: 11mm
White Nylon With Sealer
Windshield Moulding Clips

15 Pcs.

10066PK

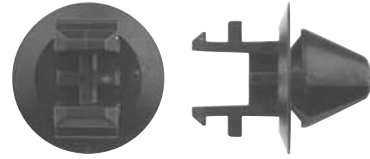

25/64" (10mm) Hole Size
Head Diameter: 20mm
Stem Length: 12mm
Black Nylon
Radiator Shroud Retainers

50 Pcs.

2161PK



5/16" (7.9mm) Hole Size
Top Head Dia.: 9/16" x 2"
Black Nylon
Rocker Panel Moulding Clips

25 Pcs.

10486PK

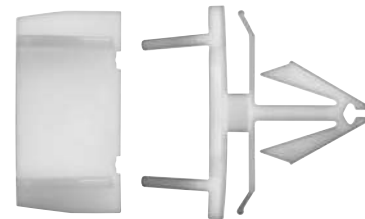

23/64" (9mm) Hole Size
Top Head Dia.: 14mm x 27mm
Stem Length: 15mm
White Nylon
Rocker Moulding Clips

25 Pcs.

10483PK

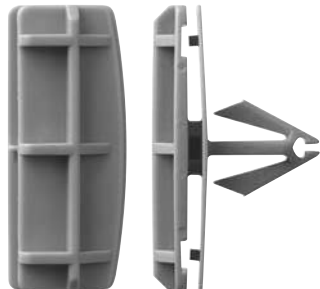

23/64" (9mm) Hole Size
Top Head Dia.: 14mm x 38mm
Stem Length: 15mm
Gray Nylon
Fender Flare Moulding Clips

15 Pcs.

10799PK

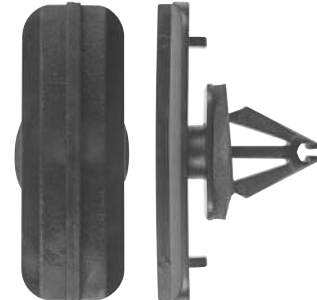

23/64" (9mm) Hole Size
Top Head Dia.: 14mm x 40mm
Stem Length: 15mm
Black Nylon
Fender Flare Moulding Clips

10 Pcs.

Metropolitan Supply

10800PK

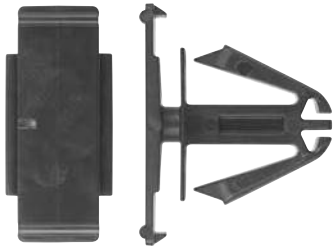

19/32" (15mm) Hole Size
Top Head Size: 11mm x 32mm
Stem Length: 20mm
Black Nylon
Front Bumper Moulding Clips

10 Pcs.

1946PK



7/16" (11mm) Hole Size
Head Dia.: 9.5mm x 10mm
Stem Length: 14mm
Green Nylon
Body Side Moulding Clips

15 Pcs.

1945PK



5/16" (8mm) Hole Size
Head Diameter: 8.5mm
Stem Length: 11mm
White Nylon
Body Side Moulding Clips

25 Pcs.

10790PK



Door and Bumper
Natural Nylon
Body Side Moulding Clips

25 Pcs.

10752PK



23/64" (9mm) Hole Size
Top Head Diameter: 12mm
Stem Length: 14mm
Orange Nylon
Cowl Vent & Radiator Support Ret.

15 Pcs.

9696PK

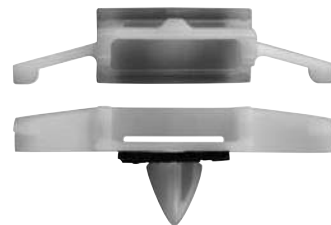

15/64" (6mm) Hole Size
Head Dia.: 10.3mm x 43mm
Stem Length: 10mm
Natural Nylon With Sealer
Drip Rail Moulding Clips

15 Pcs.

Metropolitan Supply

2142PK

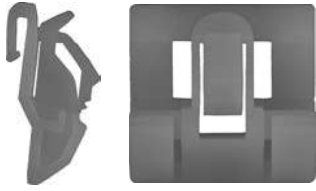

Width: 31/32"
Length: 61/64"
White Nylon
Belt Moulding Clips

10 Pcs.

9752PK

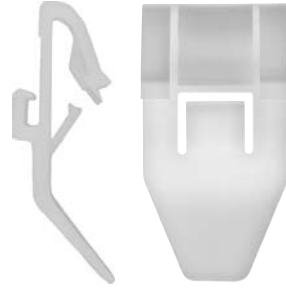

Width: 51/64"
Length: 1 5/32"
White Nylon
Belt Moulding Clips

10 Pcs.

10776PK

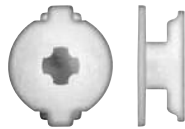

14mm Base Diameter
Small Head: 6mm x 14mm
Overall Height: 6mm
Natural Nylon
Body Side Moulding Clips

15 Pcs.

10784PK

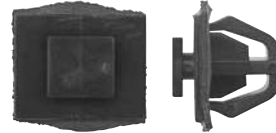

9.5mm x 12mm Hole Size
Top Head Dia.: 8mm x 9mm
Stem Length: 10mm
Black Nylon With Sealer
Body Side Moulding Clips

15 Pcs.

10780PK



9.5mm x 12mm Hole Size
Top Head Dia.: 10mm x 11mm
Stem Length: 10mm
Yellow Nylon With Sealer
Rocker Moulding Clips

15 Pcs.

10769PK



9.5mm x 12mm Hole Size
Top Head Dia.: 10mm x 12mm
Stem Length: 10mm
White Nylon With Sealer
Moulding Clips

15 Pcs.

Metropolitan Supply

10770PK



9.5mm x 12mm Hole Size
Top Head Dia.: 16mm x 20mm
Stem Length: 10mm
Yellow Nylon With Sealer
Rocker Panel Clips

15 Pcs.

10396PK

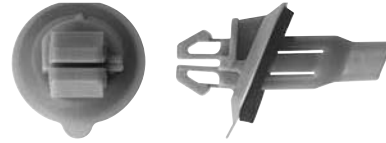

15/16" (8mm) Hole Size
Head Diameter: 18mm
Stem Length: 20mm
Gray Nylon With Sealer
Fender Moulding Clips

10 Pcs.

10397PK

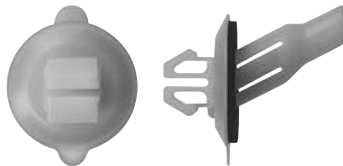

15/16" (8mm) Hole Size
Head Diameter: 18mm
Stem Length: 20mm
Yellow Nylon With Sealer
Fender Moulding Clips

10 Pcs.

10493PK

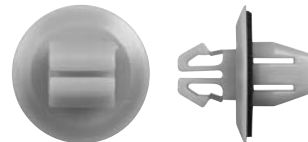

11/32" (9mm) Hole Size
Head Diameter: 18mm
Stem Length: 9mm
Pink Nylon With Sealer
Moulding Clips

15 Pcs.

10491PK

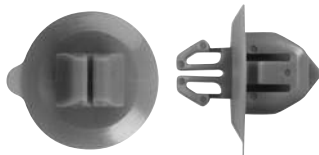

15/32" (12mm) Hole Size
Head Diameter: 18mm
Stem Length: 10mm
Gray Nylon
Rocker Panel Moulding Clips

15 Pcs.

10574PK



15/16" (8mm) Hole Size
Top Head Diameter: 14mm
Stem Length: 13mm
Black Nylon With Sealer
Cowl Panel Retainers

10 Pcs.

Metropolitan Supply

10789PK

NEW!

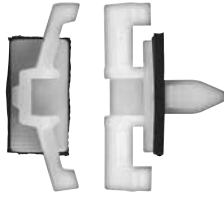

13/64" (5mm) Hole Size
 Top Head Dia.: 9mm x 25mm
 Stem Length: 10mm
 White Nylon With Sealer
 Drip Moulding Clips
 Nissan
 15 Pcs.

10742PK

NEW!

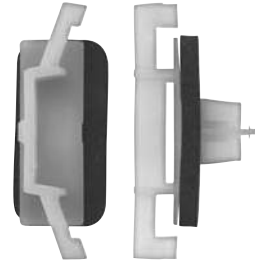

4mm x 9mm Hole Size
 Across the Top: 25mm
 Overall Length: 16mm
 White Nylon With Sealer
 Drip Moulding Clips
 Nissan
 15 Pcs.

10806PK

NEW!



13/64" (5mm) Hole Size
 Overall Length: 47mm
 Stem Length: 8mm
 Gray Nylon
 Front Bumper Moulding Clips
 10 Pcs.

10826PK

NEW!

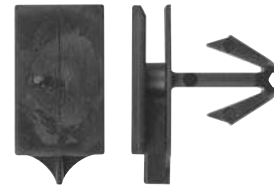

23/64" (9mm) Hole Size
 Top Head Dia.: 12mm x 20mm
 Stem Length: 15mm
 Black Nylon
 Rocker Moulding Clips
 Saturn
 15 Pcs.

10609PK

NEW!



Head Diameter: 15mm
 Stem Length: 25mm
 Black Nylon
 Front Fender & Bumper Cover Pins
 Use with # 10608
 10 Pcs.

10608PK

NEW!



25mm Width 34mm Length
 Black Nylon
 Front Fender &
 Bumper Cover Clips
 Use with # 10609
 5 Pcs.

Metropolitan Supply

10421PK



5/16" (8mm) Hole Size
Flange Diameter: 15mm
Stem Length: 10mm
Natural Nylon With Sealer
Radiator Grille Retainers

25 Pcs.

10635PK



23/64" (9mm) Hole Size
Top Head Diameter: 13mm
Stem Length: 14mm
Black Nylon
Rocker Panel & Scuff Plate Ret.

15 Pcs.

10750PK



23/64" (9mm) Hole Size
Top Head Dia.: 10mm x 13mm
Stem Length: 9mm
Yellow Nylon
Fender Flare Retainers

25 Pcs.

10392PK

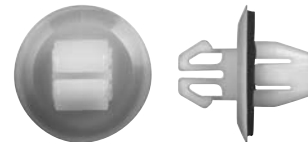

11/32" (9mm) Hole Size
Head Diameter: 18mm
Stem Length: 17mm
White Nylon With Sealer
Rocker Panel Moulding Clips

15 Pcs.

10112PK

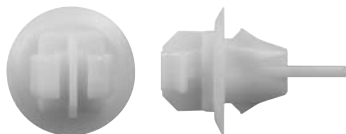

11/32" (9mm) Hole Size
Head: 17mm Stem: 17mm
Yellow Nylon
Fender & Wheel Flare
Moulding Clips

10 Pcs.

9946PK

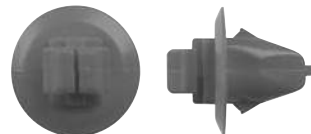

11/32" (9mm) Hole Size
Head Diameter: 17mm
Stem Length: 13mm
Red Plastic
Fender Moulding Clips

10 Pcs.

Metropolitan Supply

10113PK

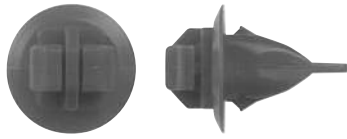

11/32" (9mm) Hole Size
Head: 17mm Stem: 17mm
Blue Nylon
Fender & Wheel Flare
Moulding Clips

10 Pcs.

10492PK

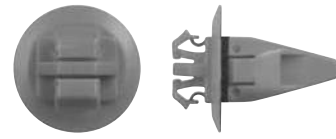

11/32" (9mm) Hole Size
Head Diameter: 17mm
Stem Length: 17mm
Orange Nylon With Sealer
Wheel Flare Moulding Clips

10 Pcs.

10490PK

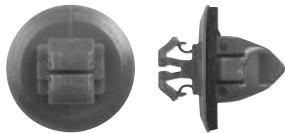

25/64" (10mm) Hole Size
Head Diameter: 17mm
Stem Length: 11mm
Blue Nylon With Sealer
Rocker Moulding Clips

10 Pcs.

10394PK

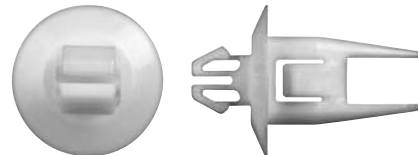

9mm x 12mm Hole Size
Head Diameter: 20mm
Stem Length: 20mm
White Nylon
Garnish Moulding Clips

10 Pcs.

10807PK



9mm Square Hole Size
Width: 30mm
Stem Length: 13mm
Black Nylon With Sealer
Front Bumper Moulding Clips

10 Pcs.

10936PK

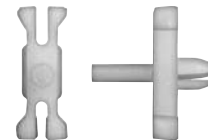

1/4" (6.5mm) Width
Over All Length: 18mm
White Nylon
Body Side Moulding Clips

50 Pcs.

Metropolitan Supply

10923PK



5/16" (8mm) Hole Size
Inside Diameter: 7mm
Stem Length: 12mm
Green Rubber
Moulding Grommets

50 Pcs.

10925PK

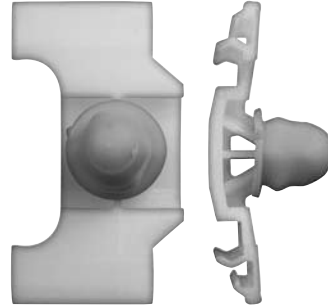

5/16" (8mm) Hole Size
Stem Length: 11mm
White Nylon
Exterior Door Moulding Clips

10 Pcs.

10921PK

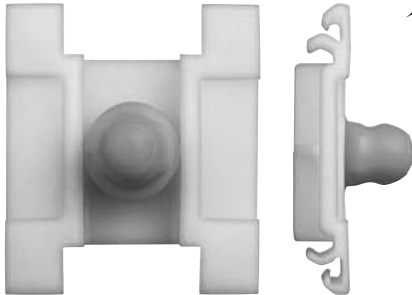

5/16" (8mm) Hole Size
Stem Length: 10mm
Exterior Door Trim
Moulding Clips

10 Pcs.

10946PK

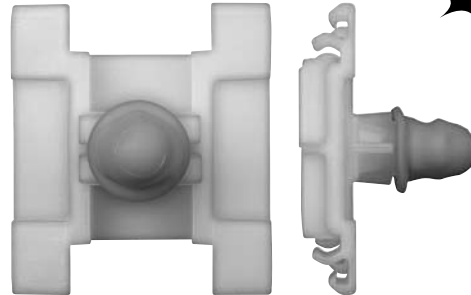

5/16" (8mm) Hole Size
Stem Length: 19mm
Exterior Door Trim
Moulding Clips

10 Pcs.

9880PK



5/16" to 1/2" Wide Mouldings
Universal Wire Type
Bright Zinc Finish
Moulding Clips
G.M.
50 Pcs.

308PK

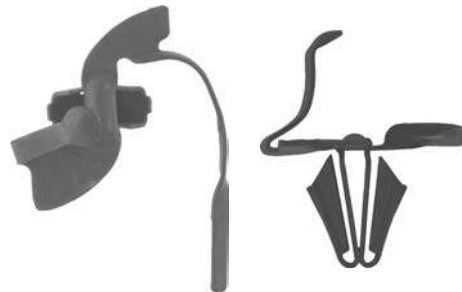

Front & Rear Door
Universal
Moulding Clips
G.M. # 4759145
50 Pcs.

315PK

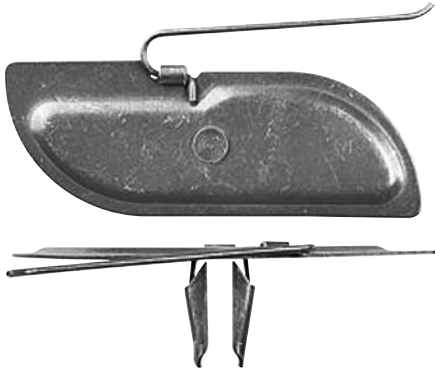

13/16" x 2 1/8" Plate Size
Universal
Moulding Clips

25 Pcs.

2194PK

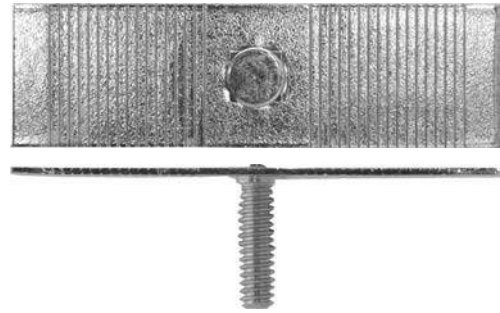

10-24 x 3/4" Screw Size
3/4" x 2 1/2" Plate Size
Breaks off in 1/16"
Bright Zinc Finish
Moulding Tee Bolts

25 Pcs.

347PK



10-24 x 5/8" Screw Size
11/32" x 23/32" Plate Size
Universal
Moulding Clips

50 Pcs.

9879PK



10-24 x 3/4" Screw Size
1/2" x 1 1/16" Plate Size
Universal
Moulding Clips

25 Pcs.

345PK

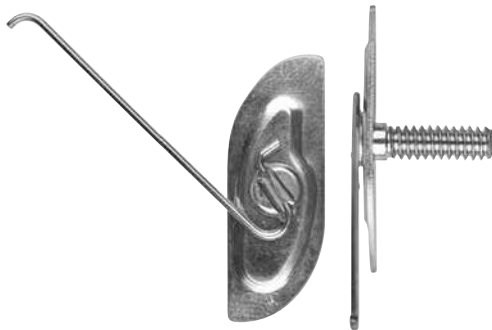

10-24 x 3/4" Screw Size
1/2" x 1 25/64" Plate Size
Universal
Moulding Clips

50 Pcs.

344PK

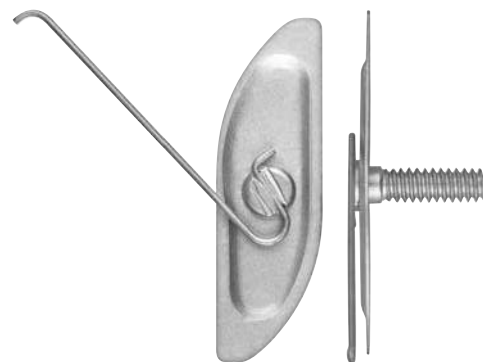

10-24 x 3/4" Screw Size
9/16" x 1 13/16" Plate Size
Universal Moulding Clips

50 Pcs.

Metropolitan Supply

589PK



5 Size
For Attaching Seat Cushions
And Cushion Springs
Metal Hog Rings
500 Pcs.

9881PK



Door & Quarter Glass
Also Door Opening
Header Bumper
G.M. # 4081765
25 Pcs.



**Depressed Center
Black Plastic
Hole Plugs**

Part Number	Hole Size	Head Diameter	Pkg Qty
9386PK	1/2"	7/8"	100
9387PK	3/4"	1 5/32"	100



**Flush Type
Black Plastic
Hole Plugs**

Part Number	Hole Size	Head Diameter	Pkg Qty
9812PK	1/4"	1/2"	100
1302PK	3/8"	3/4"	100
1091PK	1/2"	7/8"	100
1379PK	3/4"	1"	100

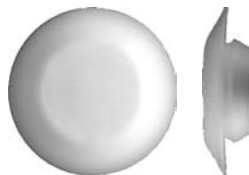

**Flush Type
White Plastic
Hole Plugs**

Part Number	Hole Size	Head Diameter	Pkg Qty
9827PK	1/4"	1/2"	50
9828PK	3/8"	3/4"	50
9829PK	1/2"	7/8"	50
9830PK	3/4"	1"	50

White Color Plugs are used Mostly on
White Automobiles for Paintless Dent Repair



**Flush Type
Black Nylon
Locking Hole Plugs**

Part Number	Hole Size	Head Diameter	Pkg Qty
9844PK	3/16"	1/4"	100
2051PK	1/4"	5/16"	50
2052PK	5/16"	3/8"	50
2053PK	3/8"	15/32"	50
2225PK	1/2"	37/64"	50
9831PK	3/4"	59/64"	50

Metropolitan Supply

9636PK



1/16" Thick
3/8" Slot
15/16" Round
Bright Zinc Finish
Steel Body Shims
50 Pcs.

9637PK



1/8" Thick
3/8" Slot
15/16" Round
Bright Zinc Finish
Steel Body Shims
50 Pcs.

6015PK



1/16" Thick
3/8" Slot
1 1/4" x 1 1/8"
Bright Zinc Finish
Steel Body Shims
100 Pcs.

6016PK



1/8" Thick
3/8" Slot
1 1/4" x 1 1/8"
Bright Zinc Finish
Steel Body Shims
100 Pcs.

9974PK

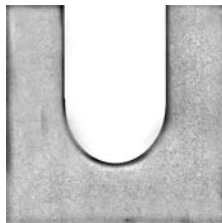

1/16" Thick
1/2" Slot
1 1/8" x 1 1/8"
Bright Zinc Finish
Steel Body Shims
50 Pcs.

9975PK

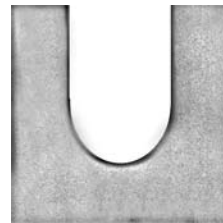

1/8" Thick
1/2" Slot
1 1/8" x 1 1/8"
Bright Zinc Finish
Steel Body Shims
50 Pcs.

6022PK

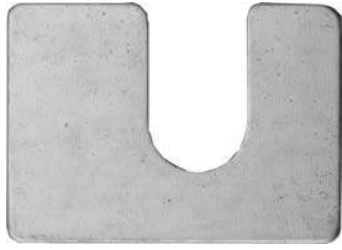

1/16" Thick
1/2" Slot
1 1/4" x 1 3/4"
Bright Zinc Finish
Steel Body Shims

50 Pcs.

6020PK

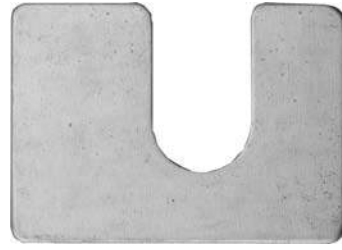

1/8" Thick
1/2" Slot
1 1/4" x 1 3/4"
Bright Zinc Finish
Steel Body Shims

50 Pcs.

10985PK



3/16" Thick
5/8" Slot
1 3/8" x 1 1/4"
Bright Zinc Finish
Steel Body Shims

25 Pcs.

6018PK

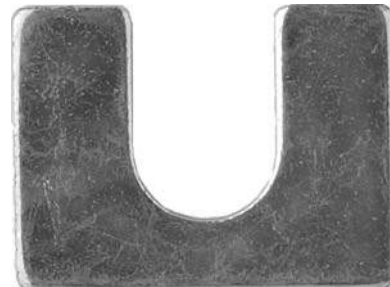

1/8" Thick
3/4" Slot
2" x 1 1/2"
Bright Zinc Finish
Steel Body Shims

50 Pcs.

9757PK



**PLUG MUST BE
REPLACED EACH
TIME THE OIL
IS CHANGED**

1/2" Hole
Replaces Standard Drain Plugs
When Threads are Stripped in Pan
Black Rubber Universal Drain Plug

1 Pc.

9758PK

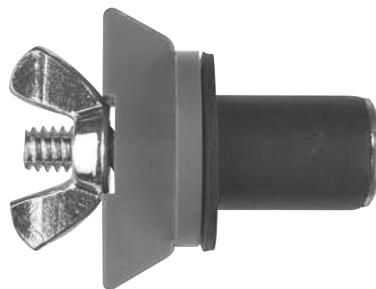

**PLUG MUST BE
REPLACED EACH
TIME THE OIL
IS CHANGED**

5/8" Hole
Replaces Standard Drain Plugs
When Threads are Stripped in Pan
Black Rubber Universal Drain Plug

1 Pc.

Metropolitan Supply

10475PK



Size # 2
3/8" I.D. 3/4" O.D.
Self-Piercing
Nickel on Brass
Grommets & Washers
144 Pcs.

9756



1/8" Thick 1/2" Wide
50 Feet Long
Black Adhesive
Sponge Weatherstrip

Sold per Roll

9823PK



Used for scraping windshields
with special coatings;
prevents windshield
coating damage
Plastic Single Edge
Razor Blades
25 Pcs.

10690

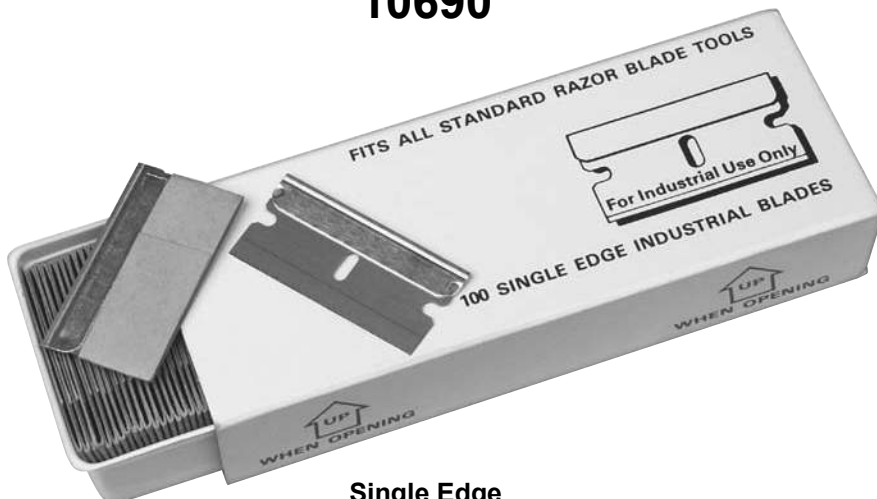

Single Edge
Industrial Razor Blades
100 Pcs.

Hose Clamps



Breeze
5/16" and 1/2" Band Width
Stainless Steel
Worm Gear Hose Clamps

Part Number	SAE Size	Clamp Range	Hose Inside Diameter	Band Width	Screw Hex Size
04	# 4 Mini	1/4" - 5/8"	1/8" - 5/16"	5/16"	1/4"
06	# 6 Mini	5/16" - 7/8"	1/4" - 7/16"	5/16"	1/4"
08	# 8 Standard	7/16" - 1"	5/16" - 1/2"	1/2"	5/16"
10	# 10 Standard	1/2" - 1 1/16"	3/8" - 5/8"	1/2"	5/16"
12	# 12 Standard	1/2" - 1 1/4"	3/8" - 3/4"	1/2"	5/16"
16	# 16 Standard	11/16" - 1 1/2"	3/4" - 7/8"	1/2"	5/16"
20	# 20 Standard	3/4" - 1 3/4"	3/4" - 1 1/8"	1/2"	5/16"
24	# 24 Standard	1" - 2"	7/8" - 1 3/8"	1/2"	5/16"
28	# 28 Standard	1 1/4" - 2 1/4"	1 1/4" - 1 5/8"	1/2"	5/16"
32	# 32 Standard	1 1/2" - 2 1/2"	1 1/2" - 1 7/8"	1/2"	5/16"
36	# 36 Standard	1 3/4" - 2 3/4"	1 3/4" - 2"	1/2"	5/16"
40	# 40 Standard	2" - 3"	2" - 2 1/4"	1/2"	5/16"
104	# 104 Standard	5" - 7"	5" - 6 1/2"	1/2"	5/16"

Hose or Clamp Dimensional Sizing Chart

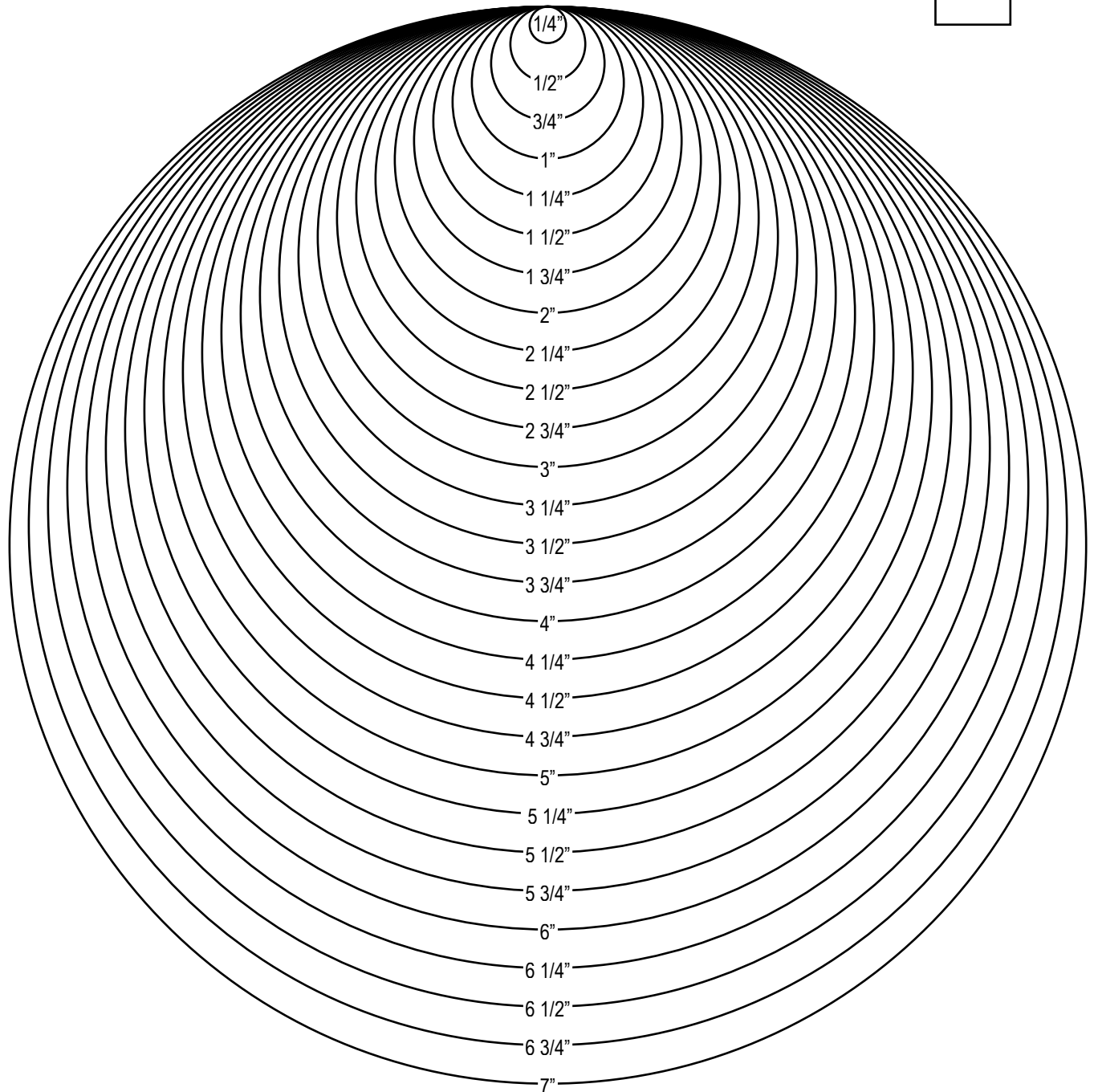
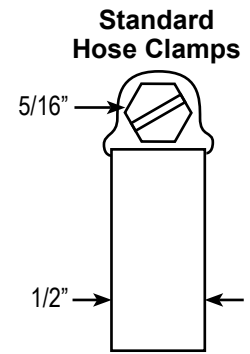
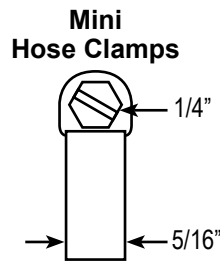
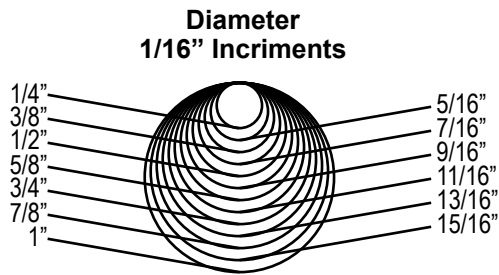



Rivets

Metropolitan Supply

1374PK



5/32" (4mm) Hole Size
Grip Range: 1/4" - 13/32"
Rectangle Flange
Black Nylon
Blind Rivets

25 Pcs.

5768PK



3/16" (5mm) Hole Size
Grip Range: 5/32" - 1/4"
Flange Diameter: 11/32"
Black Nylon
Blind Rivets

25 Pcs.

10565PK



13/64" (5.15mm) Hole Size
Grip Range: 1/8" - 5/32"
Flange Diameter: 11/32"
Black Nylon
Blind Rivets

25 Pcs.

9053PK



13/64" (5.15mm) Hole Size
Grip Range: 1/16" - 11/64"
Flange Diameter: 15/32"
Black Nylon
Blind Rivets

25 Pcs.

5769PK



13/64" (5.15mm) Hole Size
Grip Range: 1/8" - 15/64"
Flange Diameter: 15/32"
Black Nylon
Blind Rivets

25 Pcs.

1195PK



13/64" (5.15mm) Hole Size
Grip Range: 15/64" - 25/64"
Flange Diameter: 15/32"
Black Nylon
Blind Rivets

25 Pcs.

Metropolitan Supply

2080PK



15/64" (5.95mm) Hole Size
Grip Range: 11/64" - 11/32"
Flange Diameter: 1/2"
Black Nylon
Blind Rivets

25 Pcs.

1390PK



1/4" (6.35mm) Hole Size
Grip Range: 5/32" - 13/32"
Flange Diameter: 1/2"
Black Nylon
Blind Rivets

25 Pcs.

10560PK



1/4" (6.35mm) Hole Size
Grip Range: 5/32" - 9/32"
Flange Diameter: 1/2"
Black Nylon
Blind Rivets

25 Pcs.

9054PK



17/64" (6.74mm) Hole Size
Grip Range: 3/32" - 3/16"
Flange Diameter: 1/2"
Black Nylon
Blind Rivets

25 Pcs.

9854PK



15/64" (5.95mm) Hole Size
Grip Range: 5/32" - 5/16"
Flange Diameter: 5/8"
Black Nylon
Blind Rivets

25 Pcs.

10562PK



1/4" (6.35mm) Hole Size
Grip Range: 5/32" - 1/4"
Flange Diameter: 21/32"
Black Nylon
Blind Rivets

25 Pcs.

Metropolitan Supply

10630PK

NEW!



1/4" (6.35mm) Hole Size
Panel Range: 5/32" - 3/8"
Flange Diameter: 21/32"
Black Nylon
Blind Rivets

25 Pcs.

10561PK

NEW!



1/4" (6.35mm) Hole Size
Panel Range: 5/32" - 3/8"
Flange Diameter: 11/16"
Gray Nylon
Blind Rivets

25 Pcs.

5770PK



1/4" (6.35mm) Hole Size
Grip Range: 5/32" - 13/32"
Flange Diameter: 21/32"
Black Nylon
Blind Rivets

25 Pcs.

9128PK



1/4" (6.35mm) Hole Size
Grip Range: 5/16" - 15/32"
Flange Diameter: 21/32"
Black Nylon
Blind Rivets

25 Pcs.

5775PK



17/64" (6.74mm) Hole Size
Grip Range: 3/32" - 3/16"
Flange Diameter: 23/32"
Black Nylon
Blind Rivets

25 Pcs.

1467PK



9/32" (7.14mm) Hole Size
Grip Range: 3/32" - 15/64"
Flange Diameter: 23/32"
Black Nylon
Blind Rivets

25 Pcs.

Metropolitan Supply

10563PK



1/4" (6.35mm) Hole Size
Grip Range: 1/32" - 11/64"
Flange Diameter: 21/32"
Black Nylon
Blind Rivets

25 Pcs.

10564PK

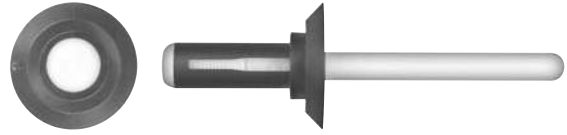

1/4" (6.35mm) Hole Size
Grip Range: 1/32" - 3/16"
Flange Diameter: 21/32"
Black Nylon
Blind Rivets

25 Pcs.

9893PK



1/8" (3.1mm) Hole Size
Grip Range: 3/16" - 1/4"
Special Small Flange Dia.: 3/16"
Stainless Steel Rivet Steel Mandrel
Moulding Stud Rivets

100 Pcs.

9243PK



1/8" (3.1mm) Hole Size
Grip Range: 3/16" - 1/4"
Flange Diameter: 1/4"
Black Finish All Aluminum
Pop Rivets
Industrial # 44
100 Pcs.

9454PK



1/8" (3.1mm) Hole Size
Grip Range: 3/16" - 1/4"
Black Finish All Aluminum
Luggage Rack Sealing Strip
Closed End Pop Rivets

50 Pcs.

9118PK



1/8" (3.1mm) Hole Size
Grip Range: 1/16" - 1/8"
Flange Diameter: 3/8"
Black Alum. Rivet Steel Mandrel
Windshield Side Rail Rivets

50 Pcs.

Metropolitan Supply

1799PK



1/8" (3.1mm) Hole Size
Grip Range: 1/8" - 3/16"
Flange Diameter: 3/8"
Black Alum. Rivet Steel Mandrel
Pop Rivets
50 Pcs.

1607PK



5/32" (3.9mm) Hole Size
Grip Range: 1/8" - 3/16"
Flange Dia.: 5/16" Countersunk Hd
All Aluminum Closed End
Swivel Emblem Lock Rivets

25 Pcs.

9277PK



5/32" (3.9mm) Hole Size
Grip Range: 1/4" - 3/8"
Flange Diameter: 15/32"
Black Alum. Rivet Steel Mandrel
Wheel Opening Mldg. Pop Rivets

25 Pcs.

10765PK



4mm Hole Size
Grip Range: .8mm - 1.5mm
Flange Diameter: 10mm
Alum. Rivet Steel Mandrel
Nylon Capped Pop Rivets

15 Pcs.

10507PK



4mm Hole Size
Grip Range: 1.2mm - 3.4mm
Flange Diameter: 6mm
Alum. Rivet Steel Mandrel
Nylon Capped Pop Rivets

10 Pcs.

10508PK



4mm Hole Size
Grip Range: 1.2mm - 4mm
Flange Diameter: 9mm
Alum. Rivet Steel Mandrel
Nylon Capped Pop Rivets

10 Pcs.

10509PK

NEW!



4mm Hole Size
Grip Range: 1mm - 4.8mm
Flange Diameter: 9mm
Alum. Rivet Steel Mandrel
Nylon Capped Pop Rivets

10 Pcs.

10458PK

NEW!



4mm Hole Size
Grip Range: 4mm - 8mm
Flange Diameter: 9mm
Alum. Rivet Steel Mandrel
Nylon Capped Pop Rivets

15 Pcs.

1609PK



3/16" (4.7mm) Hole Size
Grip Range: 5/64" - 15/64"
Flange Diameter: 7/16"
Wheel House Mldg. & Univ.
Black Alum. Split-Type Rivets

25 Pcs.

9718PK



3/16" (4.7mm) Hole Size
Grip Range: 1/16" - 17/64"
Flange Diameter: 3/8"
Black All Steel Rivet
Outside Door Handle Rivets

25 Pcs.

9278PK



3/16" (4.7mm) Hole Size
Grip Range: 3/64" - 11/32"
Flange Diameter: 3/8"
Moulding Attachment
Black Alum. Split-Type Rivets

25 Pcs.

2287PK

NEW!

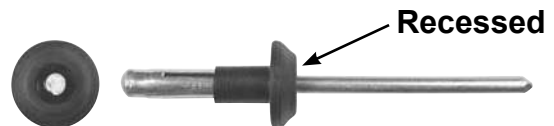

5/32" (4mm) Hole Size
Grip Range: 3mm - 8.5mm
Flange Diameter: 12mm
Alum. Rivet Black Poly.Coated Flange
Bumper & Wheel Housing Rivets

15 Pcs.

Metropolitan Supply

9453PK



3/16" (4.7mm) Hole Size
Grip Range: 3/8" - 1/2"
Flange Diameter: 3/8"
Black All Aluminum
Closed End Pop Rivets

25 Pcs.

4005PK



3/16" (4.7mm) Hole Size
Grip Range: 3/8" - 1/2"
FFlange Diameter: 9/16"
All Aluminum
Black Grille & Fascia Rivets

25 Pcs.

9618PK



3/16" (4.7mm) Hole Size
Grip Range: 11/16" - 13/16"
Flange Diameter: 3/4"
Grille & Bumper
All Aluminum Pop Rivets

25 Pcs.

10764PK



5mm Hole Size
Grip Range: 4mm - 7mm
Flange Diameter: 13mm
Alum. Rivet Steel Mandrel
Nylon Capped Pop Rivets

10 Pcs.

10510PK



5mm Hole Size
Grip Range: 3mm - 8mm
Flange Diameter: 14mm
Alum. Rivet Steel Mandrel
Nylon Capped Pop Rivets

10 Pcs.

10459PK

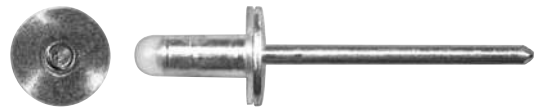

6mm Hole Size
Grip Range: 1.6mm - 6.35mm
Flange Diameter: 13.5mm
Alum. Rivet Steel Mandrel
Nylon Capped Pop Rivets

15 Pcs.

Metropolitan Supply

9644PK



1/4" (6.3mm) Hole Size
Grip Range: 3/64" - 5/64"
Flange: 19/32" Shoulder Dia.: 13/32"
All Steel Bright Zinc Finish
Headlight Retainer Rivets

25 Pcs.

4009PK



1/4" (6.3mm) Hole Size
Grip Range: 3/32" - 1/8"
Flange Diameter: 1/2"
Aluminum Rivet Steel Mandrel
Black Outside Door Handle Rivets

25 Pcs.

4007PK



1/4" (6.3mm) Hole Size
Grip Range: 1/32" - 9/64"
Flange Diameter: 1/2"
Aluminum Rivet Steel Mandrel
Window Regulator Peel Rivets

25 Pcs.

9902PK



1/4" (6.3mm) Hole Size
Grip Range: 9/64" - 3/16"
Flange Diameter: 1/2"
Aluminum Rivet Steel Mandrel
Window Regulator Peel Rivets

25 Pcs.

1415PK

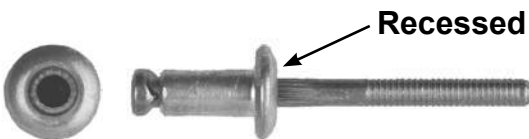

1/4" (6.3mm) Hole Size
Grip Range: 1/32" - 7/32"
Flange Diameter: 1/2"
Aluminum Rivet Steel Mandrel
Outside Door Handle Rivets

25 Pcs.

4014PK

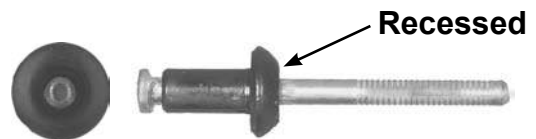

1/4" (6.3mm) Hole Size
Grip Range: 1/32" - 7/32"
Flange Diameter: 1/2"
Aluminum Rivet Steel Mandrel
Black Door Handle Rivets

15 Pcs.

Metropolitan Supply

9885PK



1/4" (6.3mm) Hole Size
Grip Range: 1/8" - 1/4"
Flange Diameter: 1/2"
All Steel Yellow Zinc Dichromate
Front Bumper Assembly Rivets

25 Pcs.

4002PK



1/4" (6.3mm) Hole Size
Grip Range: 1/8" - 1/4"
Flange Diameter: 3/4"
Black Rivet All Steel
Bumper Assembly Rivets

25 Pcs.

9989PK



1/4" (6.3mm) Hole Size
Grip Range: 1/8" - 21/64"
Flange Diameter: 3/4"
Black Alum. Rivet Steel Mandrel
Door Lock Actuator Rivets

10 Pcs.

4015PK

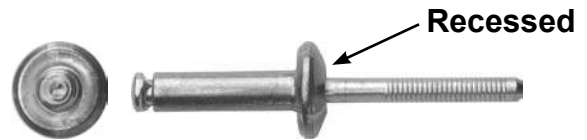

1/4" (6.3mm) Hole Size
Grip Range: 25/64" - 21/32"
Flange Diameter: 5/8"
Aluminum Rivet Steel Mandrel
Door Glass Peel Rivets

15 Pcs.

10828PK



1/4" (6.3mm) Hole Size
Grip Range: 1/4" - 9/16"
Flange Diameter: 3/4"
All Steel
Assembly Type Pop Rivets

25 Pcs.

1951PK



1/4" (6.3mm) Hole Size
Grip Range: 3/16" - 3/8"
Flange Diameter: 11/16"
Black Alum. Split Type Rivets
Bumper Cover

15 Pcs.

Metropolitan Supply

4008PK



1/4" (6.3mm) Hole Size
Grip Range: 33/64" - 19/32"
Flange Diameter: 1/2"
Aluminum Rivet Steel Mandrel
Glass Stop Peel Rivets

25 Pcs.

10605PK



1/8" Rivet Size
3/8" Outside Diameter
Bright Zinc Finish
Rivet Back-Up Washers
100 Pcs.

10606PK



3/16" Rivet Size
1/2" Outside Diameter
Bright Zinc Finish
Rivet Back-Up Washers
100 Pcs.

4011PK



Some Installations
may require
5/8" Washer
(Some provided)

Remove & Resetting Door Glass
Made Easy, Fits Most:
Ford, G.M., Chry. Products
Black Zytel Nylon
Door Glass Replacement Kits
50 Pcs.

Metropolitan Supply

All Aluminum Blind Rivets

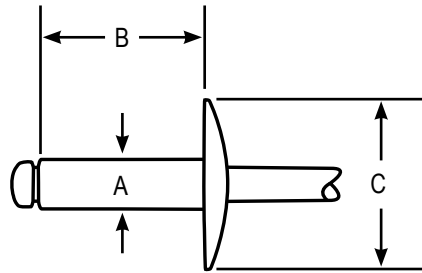

Part Number	Industrial Number	A Rivet Diameter	B Rivet Length	C Flange Diameter	Flange Type	Grip Range	Material Type Rivet/Mandrel	Pkg Qty
10585PK	32	3/32"	13/64"	3/16"	Dome	To - 1/8"	Alum/Alum	100
10586PK	34	3/32"	11/32"	3/16"	Dome	1/8" - 1/4"	Alum/Alum	100
10587PK	41	1/8"	11/64"	1/4"	Dome	1/32" - 1/16"	Alum/Alum	100
1888PK	42	1/8"	15/64"	1/4"	Dome	1/16" - 1/8"	Alum/Alum	100
10588PK	42L	1/8"	15/64"	3/8"	Lg Flange	1/16" - 1/8"	Alum/Alum	100
10589PK	43	1/8"	19/64"	1/4"	Dome	1/8" - 3/16"	Alum/Alum	100
1889PK	44	1/8"	23/64"	1/4"	Dome	3/16" - 1/4"	Alum/Alum	100
9596PK	44L	1/8"	23/64"	3/8"	Lg Flange	3/16" - 1/4"	Alum/Alum	100
10590PK	45	1/8"	27/64"	1/4"	Dome	1/4" - 5/16"	Alum/Alum	100
1890PK	46	1/8"	31/64"	1/4"	Dome	5/16" - 3/8"	Alum/Alum	100
10124PK	46L	1/8"	31/64"	3/8"	Lg Flange	5/16" - 3/8"	Alum/Alum	100
1891PK	48	1/8"	39/64"	1/4"	Dome	3/8" - 1/2"	Alum/Alum	100
10592PK	52	5/32"	1/4"	5/16"	Dome	1/16" - 1/8"	Alum/Alum	100
10593PK	53	5/32"	5/16"	5/16"	Dome	1/8" - 3/16"	Alum/Alum	100
9572PK	54	5/32"	3/8"	5/16"	Dome	3/16" - 1/4"	Alum/Alum	100
10594PK	54L	5/32"	3/8"	15/32"	Lg Flange	3/16" - 1/4"	Alum/Alum	50
10595PK	56	5/32"	1/2"	5/16"	Dome	1/4" - 3/8"	Alum/Alum	100
10596PK	58	5/32"	5/8"	5/16"	Dome	3/8" - 1/2"	Alum/Alum	50
1899PK	62	3/16"	9/32"	3/8"	Dome	1/16" - 1/8"	Alum/Alum	100
1900PK	64	3/16"	13/32"	3/8"	Dome	1/8" - 1/4"	Alum/Alum	100
1903PK	64L	3/16"	13/32"	5/8"	Lg Flange	1/8" - 1/4"	Alum/Alum	50
1901PK	66	3/16"	17/32"	3/8"	Dome	1/4" - 3/8"	Alum/Alum	100
1904PK	66L	3/16"	17/32"	5/8"	Lg Flange	1/4" - 3/8"	Alum/Alum	100
1902PK	68	3/16"	21/32"	3/8"	Dome	3/8" - 1/2"	Alum/Alum	100
1905PK	68L	3/16"	21/32"	5/8"	Lg Flange	3/8" - 1/2"	Alum/Alum	50
10597PK	610	3/16"	25/32"	3/8"	Dome	1/2" - 5/8"	Alum/Alum	100
10598PK	610L	3/16"	25/32"	5/8"	Lg Flange	1/2" - 5/8"	Alum/Alum	25
10599PK	612	3/16"	29/32"	3/8"	Dome	5/8" - 3/4"	Alum/Alum	50
10600PK	84	1/4"	29/64"	1/2"	Dome	3/16" - 1/4"	Alum/Alum	25
10601PK	86	1/4"	37/64"	1/2"	Dome	1/4" - 3/8"	Alum/Alum	25
10602PK	88	1/4"	11/16"	1/2"	Dome	3/8" - 1/2"	Alum/Alum	25
10603PK	810	1/4"	53/64"	1/2"	Dome	1/2" - 5/8"	Alum/Alum	25
10604PK	812	1/4"	15/16"	1/2"	Dome	5/8" - 3/4"	Alum/Alum	25

All Steel Blind Rivets

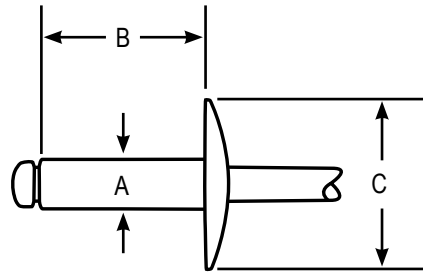

Part Number	Industrial Number	A Rivet Diameter	B Rivet Length	C Flange Diameter	Flange Type	Grip Range	Material Type Rivet/Mandrel	Pkg Qty
11078PK	32	3/32"	13/64"	3/16"	Dome	To - 1/8"	Steel/Steel	100
11079PK	34	3/32"	11/32"	3/16"	Dome	1/8" - 1/4"	Steel/Steel	100
11080PK	41	1/8"	11/64"	1/4"	Dome	1/32" - 1/16"	Steel/Steel	100
11081PK	42	1/8"	15/64"	1/4"	Dome	1/16" - 1/8"	Steel/Steel	100
11103PK	42L	1/8"	15/64"	3/8"	Lg Flange	1/16" - 1/8"	Steel/Steel	100
11082PK	43	1/8"	19/64"	1/4"	Dome	1/8" - 3/16"	Steel/Steel	100
11083PK	44	1/8"	23/64"	1/4"	Dome	3/16" - 1/4"	Steel/Steel	100
11104PK	44L	1/8"	23/64"	3/8"	Lg Flange	3/16" - 1/4"	Steel/Steel	100
11084PK	45	1/8"	27/64"	1/4"	Dome	1/4" - 5/16"	Steel/Steel	100
11085PK	46	1/8"	31/64"	1/4"	Dome	5/16" - 3/8"	Steel/Steel	100
11105PK	46L	1/8"	31/64"	3/8"	Lg Flange	5/16" - 3/8"	Steel/Steel	100
11086PK	48	1/8"	39/64"	1/4"	Dome	3/8" - 1/2"	Steel/Steel	100
11087PK	52	5/32"	1/4"	5/16"	Dome	1/16" - 1/8"	Steel/Steel	100
11088PK	53	5/32"	5/16"	5/16"	Dome	1/8" - 3/16"	Steel/Steel	100
11089PK	54	5/32"	3/8"	5/16"	Dome	3/16" - 1/4"	Steel/Steel	100
11106PK	54L	5/32"	3/8"	15/32"	Lg Flange	3/16" - 1/4"	Steel/Steel	50
11090PK	56	5/32"	1/2"	5/16"	Dome	1/4" - 3/8"	Steel/Steel	100
11091PK	58	5/32"	5/8"	5/16"	Dome	3/8" - 1/2"	Steel/Steel	50
11092PK	62	3/16"	9/32"	3/8"	Dome	1/16" - 1/8"	Steel/Steel	100
1123PK	64	3/16"	13/32"	3/8"	Dome	1/8" - 1/4"	Steel/Steel	100
11107PK	64L	3/16"	13/32"	5/8"	Lg Flange	1/8" - 1/4"	Steel/Steel	50
11094PK	66	3/16"	17/32"	3/8"	Dome	1/4" - 3/8"	Steel/Steel	100
11108PK	66L	3/16"	17/32"	5/8"	Lg Flange	1/4" - 3/8"	Steel/Steel	100
11095PK	68	3/16"	21/32"	3/8"	Dome	3/8" - 1/2"	Steel/Steel	100
11109PK	68L	3/16"	21/32"	5/8"	Lg Flange	3/8" - 1/2"	Steel/Steel	50
11096PK	610	3/16"	25/32"	3/8"	Dome	1/2" - 5/8"	Steel/Steel	100
11110PK	610L	3/16"	25/32"	5/8"	Lg Flange	1/2" - 5/8"	Steel/Steel	25
11097PK	612	3/16"	29/32"	3/8"	Dome	5/8" - 3/4"	Steel/Steel	50
11098PK	84	1/4"	29/64"	1/2"	Dome	3/16" - 1/4"	Steel/Steel	25
11099PK	86	1/4"	37/64"	1/2"	Dome	1/4" - 3/8"	Steel/Steel	25
11100PK	88	1/4"	11/16"	1/2"	Dome	3/8" - 1/2"	Steel/Steel	25
11101PK	810	1/4"	53/64"	1/2"	Dome	1/2" - 5/8"	Steel/Steel	25
11102PK	812	1/4"	15/16"	1/2"	Dome	5/8" - 3/4"	Steel/Steel	25

Metropolitan Supply

Aluminum/Steel Blind Rivets

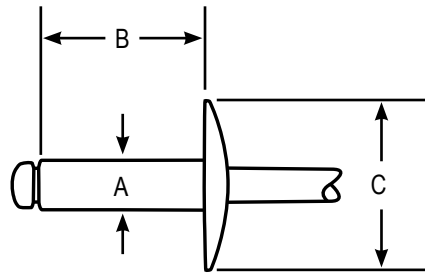

Part Number	Industrial Number	A Rivet Diameter	B Rivet Length	C Flange Diameter	Flange Type	Grip Range	Material Type Rivet/Mandrel	Pkg Qty
11045PK	32	3/32"	13/64"	3/16"	Dome	To - 1/8"	Alum/Steel	100
11046PK	34	3/32"	11/32"	3/16"	Dome	1/8" - 1/4"	Alum/Steel	100
11047PK	41	1/8"	11/64"	1/4"	Dome	1/32" - 1/16"	Alum/Steel	100
11048PK	42	1/8"	15/64"	1/4"	Dome	1/16" - 1/8"	Alum/Steel	100
11070PK	42L	1/8"	15/64"	3/8"	Lg Flange	1/16" - 1/8"	Alum/Steel	100
11049PK	43	1/8"	19/64"	1/4"	Dome	1/8" - 3/16"	Alum/Steel	100
11050PK	44	1/8"	23/64"	1/4"	Dome	3/16" - 1/4"	Alum/Steel	100
11071PK	44L	1/8"	23/64"	3/8"	Lg Flange	3/16" - 1/4"	Alum/Steel	100
11051PK	45	1/8"	27/64"	1/4"	Dome	1/4" - 5/16"	Alum/Steel	100
11052PK	46	1/8"	31/64"	1/4"	Dome	5/16" - 3/8"	Alum/Steel	100
11072PK	46L	1/8"	31/64"	3/8"	Lg Flange	5/16" - 3/8"	Alum/Steel	100
11053PK	48	1/8"	39/64"	1/4"	Dome	3/8" - 1/2"	Alum/Steel	100
11054PK	52	5/32"	1/4"	5/16"	Dome	1/16" - 1/8"	Alum/Steel	100
11055PK	53	5/32"	5/16"	5/16"	Dome	1/8" - 3/16"	Alum/Steel	100
11056PK	54	5/32"	3/8"	5/16"	Dome	3/16" - 1/4"	Alum/Steel	100
11073PK	54L	5/32"	3/8"	15/32"	Lg Flange	3/16" - 1/4"	Alum/Steel	50
11057PK	56	5/32"	1/2"	5/16"	Dome	1/4" - 3/8"	Alum/Steel	100
11058PK	58	5/32"	5/8"	5/16"	Dome	3/8" - 1/2"	Alum/Steel	50
11059PK	62	3/16"	9/32"	3/8"	Dome	1/16" - 1/8"	Alum/Steel	100
11060PK	64	3/16"	13/32"	3/8"	Dome	1/8" - 1/4"	Alum/Steel	100
11074PK	64L	3/16"	13/32"	5/8"	Lg Flange	1/8" - 1/4"	Alum/Steel	50
11061PK	66	3/16"	17/32"	3/8"	Dome	1/4" - 3/8"	Alum/Steel	100
11075PK	66L	3/16"	17/32"	5/8"	Lg Flange	1/4" - 3/8"	Alum/Steel	100
11062PK	68	3/16"	21/32"	3/8"	Dome	3/8" - 1/2"	Alum/Steel	100
11076PK	68L	3/16"	21/32"	5/8"	Lg Flange	3/8" - 1/2"	Alum/Steel	50
11063PK	610	3/16"	25/32"	3/8"	Dome	1/2" - 5/8"	Alum/Steel	100
11077PK	610L	3/16"	25/32"	5/8"	Lg Flange	1/2" - 5/8"	Alum/Steel	25
11064PK	612	3/16"	29/32"	3/8"	Dome	5/8" - 3/4"	Alum/Steel	50
11065PK	84	1/4"	29/64"	1/2"	Dome	3/16" - 1/4"	Alum/Steel	25
11066PK	86	1/4"	37/64"	1/2"	Dome	1/4" - 3/8"	Alum/Steel	25
11067PK	88	1/4"	11/16"	1/2"	Dome	3/8" - 1/2"	Alum/Steel	25
11068PK	810	1/4"	53/64"	1/2"	Dome	1/2" - 5/8"	Alum/Steel	25
11069PK	812	1/4"	15/16"	1/2"	Dome	5/8" - 3/4"	Alum/Steel	25



Electrical Products

Metropolitan Supply

9690PK

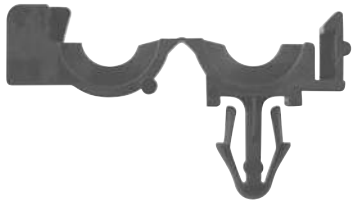

1/4" I.D." 3/8" O.D.
Black Nylon
Wire Loom Routing Clips

15 Pcs.

1237PK



11/32" I.D." 1/2" O.D.
Black Nylon
Wire Loom Routing Clips

25 Pcs.

1238PK



13/32" I.D." 19/32" O.D.
Black Nylon
Wire Loom Routing Clips

25 Pcs.

1239PK



1/2" I.D." 11/16" O.D.
Black Nylon
Wire Loom Routing Clips

25 Pcs.

1240PK



3/4" I.D." 1" O.D.
Black Nylon
Wire Loom Routing Clips

25 Pcs.

Metropolitan Supply

UV Black Nylon Cable Ties



Part Number	Length	Bundle Diameter	Tensile Strength	Pkg Qty
BK4	4"	up to 7/8"	18 LBS.	100
BK8	8"	up to 1 3/4"	50 LBS.	100
BK11	11"	up to 3"	50 LBS.	100
BK14	14"	up to 4"	50 LBS.	100
9724PK	14"(HD)	up to 4"	120 LBS.	100

9279PK



140mm Long
Max. Bundle Diameter: 30mm
Universal Use
Black Nylon
Releasable Cable Straps

25 Pcs.

9325PK



8" Length
Up To 1 3/4" Bundle Diameter
50 lbs. T/Strength 1/4" Hole Dia.
UV Black Nylon
Push-Mount Cable Ties

25 Pcs.



**Low Profile
ATM
Blade Type
Mini Fuses**

Part Number	Amp Rating	Color	Pkg Qty
ATLM05	5	Tan	20
ATLM07.5	7.5	Brown	20
ATLM10	10	Red	20
ATLM15	15	Blue	20
ATLM20	20	Yellow	20
ATLM25	25	Natural	20
ATLM30	30	Green	20



**ATM
Blade Type
Mini Fuses**

Part Number	Amp Rating	Color	Pkg Qty
Mini 5	5	Orange	25
Mini 07.5	7.5	Brown	25
Mini 10	10	Red	25
Mini 15	15	Blue	25
Mini 20	20	Yellow	25
Mini 25	25	White	25
Mini 30	30	Green	25



**ATO
Blade Type
Standard Fuses**

Part Number	Amp Rating	Color	Pkg Qty
ATO05	5	Orange	25
ATO07.5	7.5	Brown	25
ATO10	10	Red	25
ATO15	15	Blue	25
ATO20	20	Yellow	25
ATO25	25	White	25
ATO30	30	Green	25

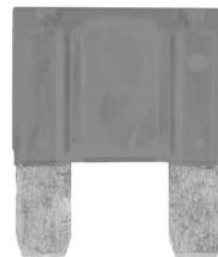

**ATX
Blade Type
Maxi Fuses**

Part Number	Amp Rating	Color	Pkg Qty
Maxi 20	20	Yellow	1
Maxi 30	30	Green	1
Maxi 40	40	Orange	1
Maxi 50	50	Red	1
Maxi 60	60	Blue	1

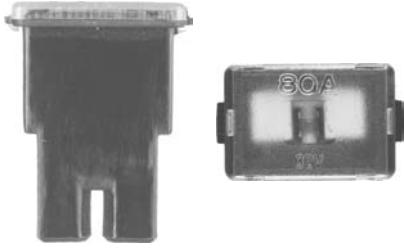

**Female
PAL
(Pacific Auto Link)
Fuses**

Part Number	Amp Rating	Color	Pkg Qty
2085PK	20	White	1
2086PK	30	Pink	1
2087PK	40	Green	1
2088PK	50	Red	1
2089PK	60	Yellow	1
2090PK	80	Black	1

10728PK

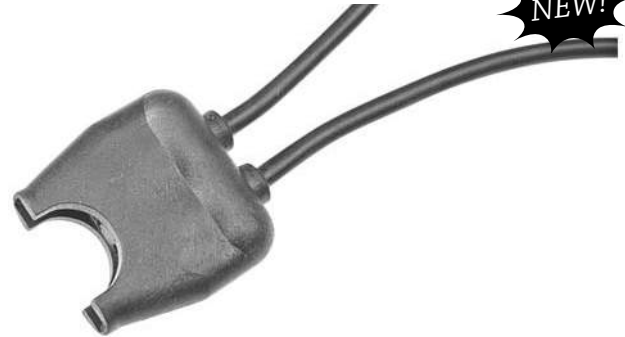

**7" Wire Leads
14 Gauge Wire
Use With ATO/ATC Fuses
Open Type
In-Line Fuse Holders
5 Pcs.**

Metropolitan Supply

10729PK

NEW!

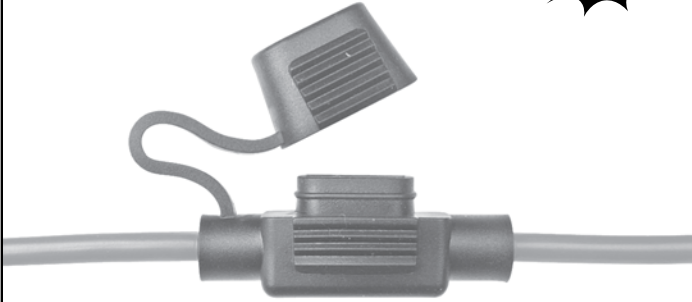

6" Wire Leads
12 Gauge Wire
Use With ATM Fuses
Closed Type
In-Line Fuse Holders
1 Pc.

10730PK

NEW!



6" Wire Leads
14 Gauge Wire
Use With ATO/ATC Fuses
Closed Type
In-Line Fuse Holders
1 Pc.

10731PK

NEW!

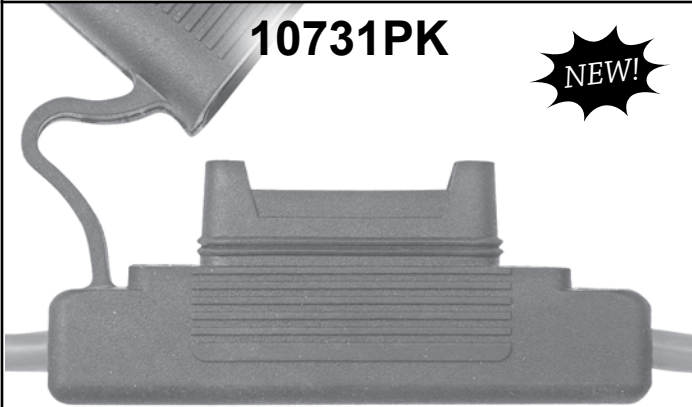

5" Wire Leads
8 Gauge Wire
Use With ATX Fuses
Closed Type
In-Line Fuse Holders
1 Pc.

1396PK



Headlamp Pigtail
(3) All Black 10" Leads 18ga
Blue Housing
Usage: Compact import and domestic cars '88+
Fits bulbs # 9004, 9007

1 Pc.

9769PK



Air Conditioning Clutch Field Coil Connector Pigtail
(2) 12" Leads Pink & Tan
Gray Housing
Usage: Ford '80+
10 Pcs.

9774PK



Stop/Tail/Turn & Parking Light Pigtail
(3) 18ga (TXL) Leads Black Brown, Green/Gold
Black Housing
Usage: Ford Ranger, Explorer, Econoline '91+
1 Pc.

Metropolitan Supply

9771PK



Power Brake Connector Pigtail
(2) 12" Leads Green & Green/Red
Black Housing
Usage: Ford '65+
Ford # D1AZ-13410-A
10 Pcs.

9767PK



Vehicle Speed Sensor Pigtail
ABS Wheel Speed Sensor
(2) White GXL 8" Leads
Black Housing
Usage: Fits various model Fords '93+
Ford Base # 9E731
1 Pc.

9768PK



Alternator Socket Assembly
(3) 10" Leads (2) 10ga Black/Orange
(1) 20ga White
Black Housing
Usage: Ford Aerostar, Tempo, Topaz, Taurus &
Sable w/ 6 Cyl. & 75 Amp. Alternator
'89+ 4 Cyl '85+
1 Pc.

9908PK



Ford Alternator Harness
(2) 16 ga. (TXL) 8" Leads
Usage: Ford Alt. F81Z-10346-EARM
Ford 250 & 350 7.3 Diesel Eng., Cr. Vic.
Grand Marq., Town Car, Contour & Mystique
Ford
1 Pc.

9907PK



Ford Alternator Harness
(3) 14 ga. (TXL) 8" Leads
Usage: Ford Alt. 1U2Z-14S411-TA, WPT118
Ford
1 Pc.

9909PK



Brake Lamp Switch
(2) 18 ga. (TXL) 8" Leads
Usage: Fits Switch
YF1Z-13480-AA & # YF1Z-13480-BA
Wire harness Connector
Ford
1 Pc.

Metropolitan Supply

9776PK



Voltage Regulator Pigtail
(3) 10" Leads (1) 14ga, (2) 20ga
Green, White, Blue
Gray Housing
Usage: Sable, Taurus, Tempo, Topaz with
Internal Voltage regulator '86+
1 Pc.

9778PK

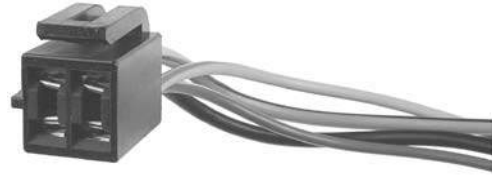

Heater & Air Conditioning Fan Speed Pigtail
(4) 8" Leads (1) 16ga (1) 14ga (2) 12ga
Yellow, Green, Orange, Black
Black Housing
Usage: Switches E6DZ-A, E9SZ-A, F2DZ-A,
F2UZ-19986A,B
Ford Cougar, E-Van, Mustang, Sable, Taurus,
T-Bird '86+
1 Pc.

9798PK



Turn Signal & Windshield Wiper Pigtail
(2) 16ga (2) 12ga (GPT) 8" Leads
Gray Housing
Usage: Ford Multiswitch Base No. 13K359
1 Pc.

9834PK



Ford Multi-Switch Function Pigtail
(9) 16ga (GPT) 8" Leads
Gray Housing
Usage: Ford Multi Function Switch Base No. 13K359
1 Pc.

9775PK



Marker & License Socket Pigtail
(2) 9" Leads Brown & Black
Beige Housing
Usage: Fits bulbs #158, 194, 194A

5 Pc.

9813PK



Blower Motor Resistor Pigtail
1st Pigtail: (1ea) 10, 12, 14, 16ga (White Housing)
2nd Pigtail: (1) 18" 12ga Lead White Housing
Usage: Fits Resistors F1CZ-19A706-A &
F7CZ-19A706-AA
Ford Escort & Tracer '91+
1 Pc.

9770PK



Heater & A/C Blower Switches Repair Pigtail
 (5) 5" 12ga Leads Red, Orange, White, Green, Black
 Gray Housing
 Usage: Fits most Ford Switches w/ Base # 19986 '73+
 1 Pc.

9777PK

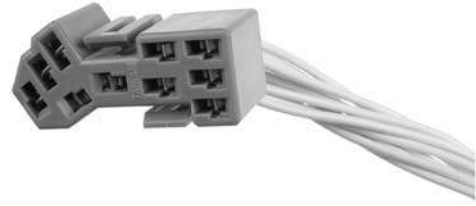

Turn Signal & Windshield Wiper Repair Pigtail
 (10) 16ga (GPT) 8" Leads
 Gray Housing
 Usage: Switches E9DZ-13K359-A, B, C;
 E8ZZ-13K359-B; F0ZZ13K1359-A
 Ford Mustang '87-93, Sable & Taurus '86-89
 1 Pc.

9799PK



Ford MultiSwitch Pigtail
 (11) 18ga (TXL) 8" Leads
 Gray Housing
 Usage: Ford Multi Function Switch Base No. 13K359
 1 Pc.

9800PK



Air Conditioning Blower Motor Resistor Pigtail
 (4) 8" Leads 14ga Black, Orange, Yellow, Green
 Black Housing
 Usage: Fits Resistor E7TZ-19A706-A
 Ford Trucks '83+
 Ford # E7TZ-19A706-A
 1 Pc.

9772PK



Dash Mounted Headlamp Switch repair Harness
 (9) 8" Leads (3) 20ga, (4) 8ga (1) 16ga (1) 12ga
 Gray Housing
 Usage: First Most Switch w/ Ford Base No. 11654
 Ford Cars / Trucks '84+
 1 Pc.

9773PK



Fuel Injection Plug w/ External Spring Clip Retainer
 (2) 18ga (SXL) Leads White
 Black Housing
 Usage: Compact import and domestic cars
 1 Pc.

Metropolitan Supply

9779PK



Light Socket Pigtail
(3) 10" Leads Yellow, Brown, Black
Beige Housing
Usage: Nissan light socket plug. Fits bulb #7443
1 Pc.

9780PK



Light Socket Pigtail
(2) 11" Leads Brown, Black
Gray Housing
Usage: Nissan light socket plug. Fits bulb #7440
1 Pc.

729PK



Use on 14-16-18 Ga. Wire
In Line Self Stripping
Blue Nylon
Wire Connectors
25 Pcs.

9996PK



Joins 18 & 16 Gauge Wire
2 #18 Ga. Wire Min.
2 #16 Ga. Wire Max.
Hard Type
Grey Wire Nuts
25 Pcs.

2066PK



22-18 Ga. Wire
UL Approved
Polyolefin Tubing Shrink Ratio 3-1
Heat Shrink Type
Red Butt Connectors
25 Pcs.

2067PK



16-14 Ga. Wire
UL Approved
Polyolefin Tubing Shrink Ratio 3-1
Heat Shrink Type
Blue Butt Connectors
25 Pcs.

Metropolitan Supply

2068PK



12-10 Ga. Wire
UL Approved
Polyolefin Tubing Shrink Ratio 3-1
Heat Shrink Type
Yellow Butt Connectors
25 Pcs.

3600PK



Red Nylon
22-18 Gauge Wire Range
Seamless Butt Connectors
50 Pcs.

3601PK



Blue Nylon
16-14 Gauge Wire Range
Seamless Butt Connectors
50 Pcs.

3602PK



Yellow Nylon
12-10 Gauge Wire Range
Seamless Butt Connectors
50 Pcs.

10710PK



22-24 AWG
Solder & Seal Type
Clear Heat Shrink Tubing
Butt Connectors
15 Pcs.

10711PK



18-20 AWG
Solder & Seal Type
Red Heat Shrink Tubing
Butt Connectors
15 Pcs.

Metropolitan Supply

10712PK



**14-16 AWG
Solder & Seal Type
Blue Heat Shrink Tubing
Butt Connectors
15 Pcs.**

10713PK



**10-12 AWG
Solder & Seal Type
Yellow Heat Shrink Tubing
Butt Connectors
15 Pcs.**

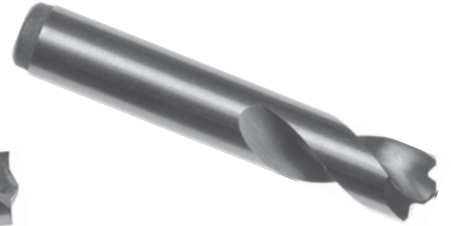
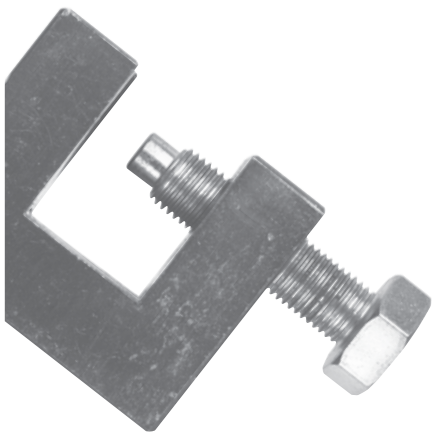

Tools



Metropolitan Supply

9956

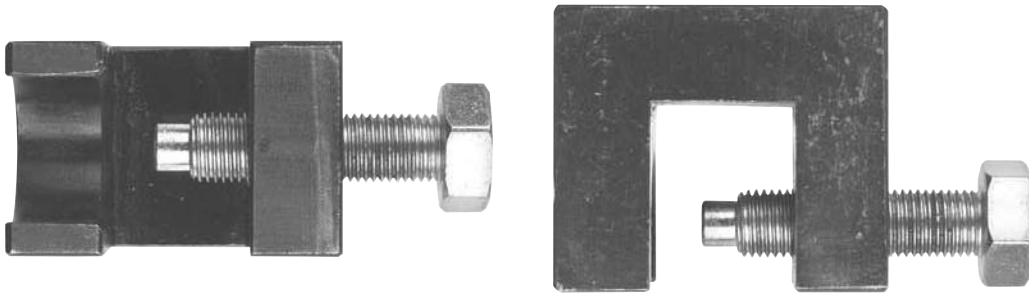

Door Hinge Pin Removal Tool
Used to remove #10060 & 10065 Hinge Pin Kits
Sold Each

10690

NEW!

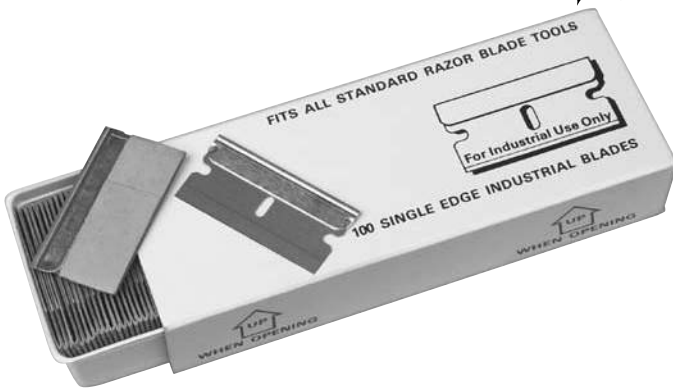

Single Edge
Industrial Razor Blades
100 Pcs.

10880PK

NEW!



6mm Drill Size
For 1/4" Spot Welds
High Speed Steel
Gold Finish Cobalt Steel
Spot Weld Drill Bits
3 Pcs.

10881PK

NEW!



8mm Drill Size
For 5/16" Spot Welds
High Speed Steel
Gold Finish Cobalt Steel
Spot Weld Drill Bits
3 Pcs.

10882PK

NEW!



10mm Drill Size
For 3/8" Spot Welds
High Speed Steel
Gold Finish Cobalt Steel
Spot Weld Drill Bits
3 Pcs.

Metropolitan Supply

10841PK

NEW!



8mm Drill Size
For 5/16" Spot Welds
Cobalt Spur Point
Gold Finish High Speed Steel
Spot Weld Drill Bits
3 Pcs.

10842PK

NEW!



10mm Drill Size
For 3/8" Spot Welds
Cobalt Spur Point
Gold Finish High Speed Steel
Spot Weld Drill Bits
3 Pcs.

10843PK

NEW!



1/8" (.125) Drill Size
135° Split Point
High Speed Steel
Double End Drill Bits
10 Pcs.

10844PK

NEW!



3/16" (.1875) Drill Size
135° Split Point
High Speed Steel
Double End Drill Bits
5 Pcs.

10845PK

NEW!



1/4" (.250) Drill Size
135° Split Point
High Speed Steel
Double End Drill Bits
5 Pcs.

Assortments

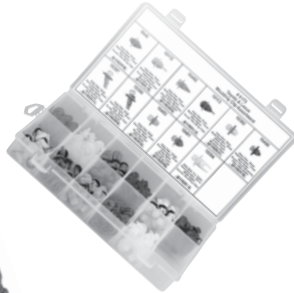
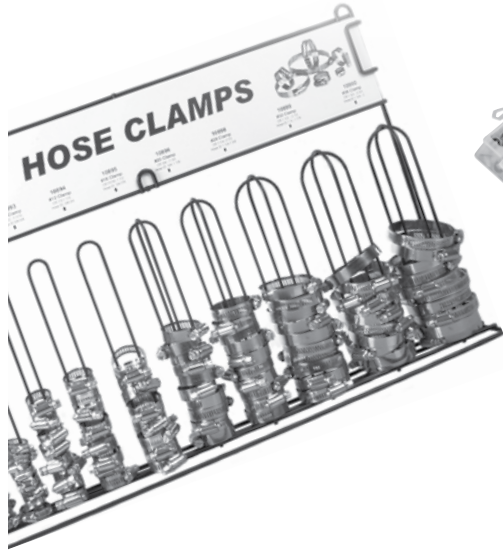
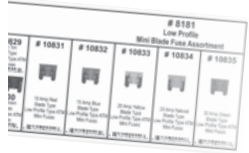
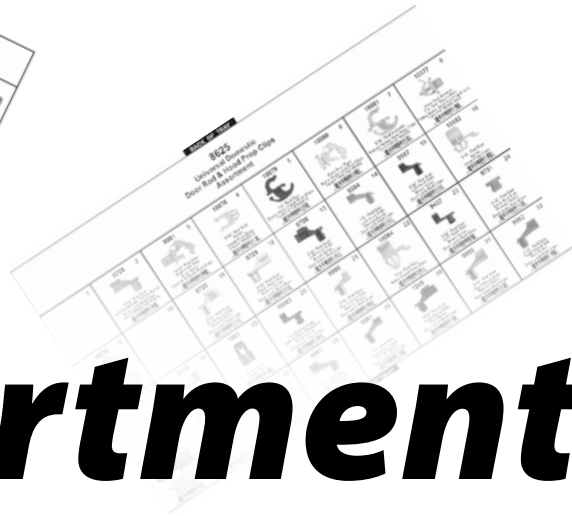
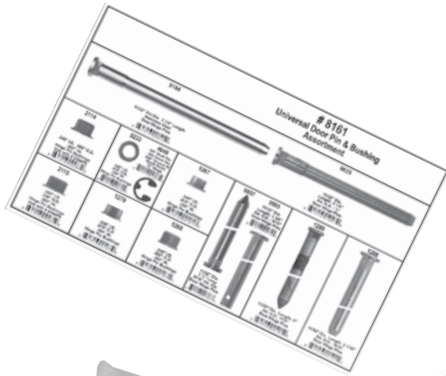

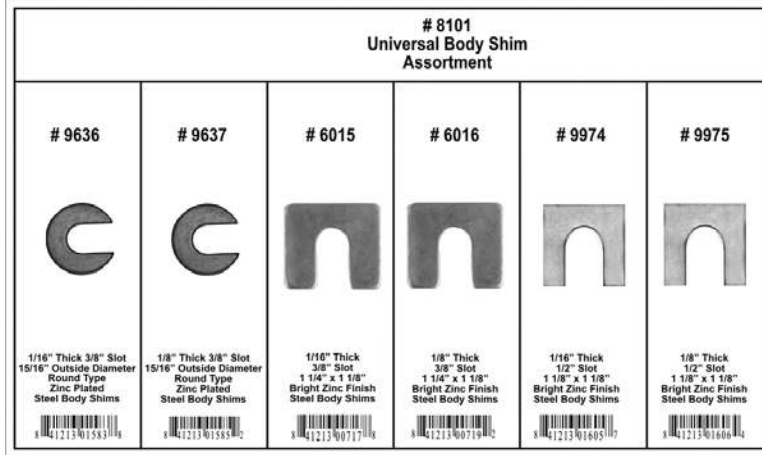

8101 (Plastic Tray)
 Shipped In a 6 Hole Plastic Tray
 Covers 3/8" & 1/2" Slot Sizes
 Bright Zinc Finish
 Contains 6 Different Sizes
 140 Total Pcs.
 Body Shim Assortment
 Sold Each



8101R (Refill Kit)
 Shipped In a 8" x 10" Plastic Bag
 Sold Each

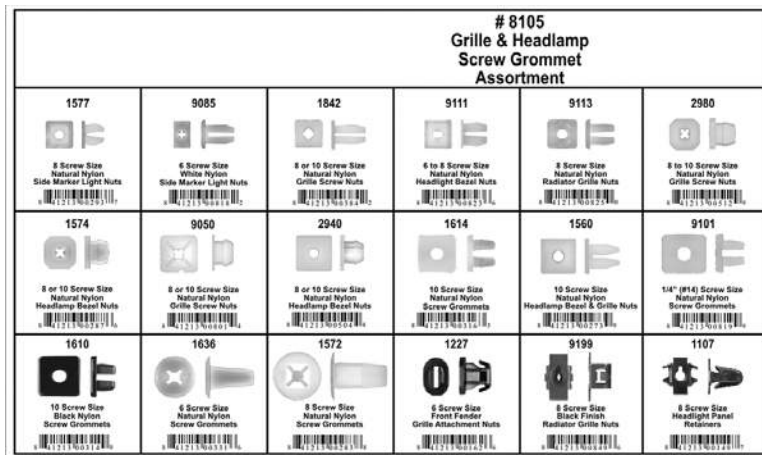
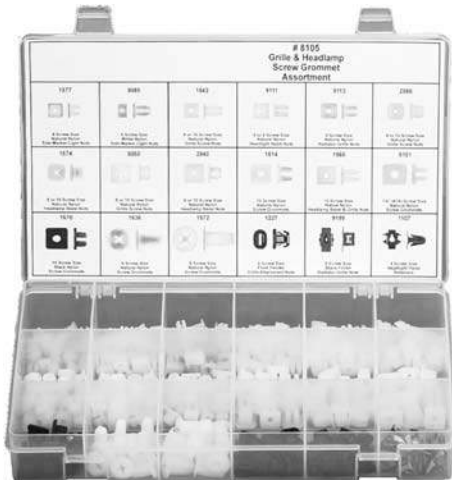

8105 (Plastic Tray)
 Shipped In a 18 Hole Plastic Tray
 Covers G.M., Ford, & Chrysler
 All Nylon
 Contains 18 Different Sizes
 330 Total Pcs.
 Grille & Headlamp Grommet Assortment
 Sold Each



# 8109 Import Fender Flare, Garnish Moulding & Door Trim Panel Retainer Assortment					
# 10750 8.2mm Hole Size Top Head Dia: 10mm x 13mm Stem Length: 11mm Toyota Yellow Nylon Fender Flare Retainers	# 10687 8.5mm Hole Size Top Head Diameter: 13mm Stem Length: 14mm Toyota Turquoise Nylon Door Trim Panel Retainers	# 10751 8.75mm Hole Size Top Head Diameter: 13mm Stem Length: 11mm Toyota White Nylon Garnish Moulding Retainers	# 2145 8mm Hole Size Top Head Diameter: 13mm Stem Length: 11mm Toyota Natural Nylon Door Trim & Garnish Retainers	# 10405 9mm Hole Size Top Head Diameter: 14mm Stem Length: 14mm Mazda White Nylon Door Trim Panel Retainers	# 10748 9mm Hole Size Stem Length: 13mm Toyota Natural Nylon Door Panel & Rocker Moulding Retainers
# 10744 8.8mm Hole Size Top Head Diameter: 13mm Stem Length: 10mm Hyundai Natural Nylon Trim Panel Retainers	# 10573 8.5mm Hole Size Top Head Diameter: 13mm Stem Length: 13mm Honda Blue Nylon Door Trim Panel Retainers	# 10752 9.1mm Hole Size Stem Length: 14mm Honda Orange Nylon Cowl Vent & Radiator Support Retainers	# 10576 8mm Hole Size Top Head Diameter: 12.8mm Stem Length: 14mm Nissan Orange Nylon With Sealer Door Trim Panel Retainers	# 10575 8mm Hole Size Top Head Diameter: 15mm Stem Length: 10mm Mazda Black Nylon Door Trim Panel Retainers	# 10749 11.1mm Hole Size Stem Length: 14mm Mazda White Nylon Door Trim Panel Retainers With Sealer

8109 (Plastic Tray)
Shipped In a 12 Hole Plastic Tray
Covers Honda, Hyundai, Nissan,
Mazda & Toyota Cars
Contains 12 Different Sizes
170 Total Pcs.
Import Door Trim Panel Assortment
Sold Each

*Color Sales Brochures Available. Call for Details.



# 8110 ATM-ATO-ATX Blade Fuse Assortment					
# 1735PK 7.5 Amp Silver ATM Type Mini Fuse	# 1736PK 10 Amp Red ATM Type Mini Fuse	# 1737PK 15 Amp Blue ATM Type Mini Fuse	# 1738PK 20 Amp Yellow ATM Type Mini Fuse	# 1739PK 25 Amp Green ATM Type Mini Fuse	# 1740PK 30 Amp Cyan ATM Type Mini Fuse
# 1709PK 3 Amp Orange ATO Type Standard Fuse	# 1710PK 7.5 Amp Brown ATO Type Standard Fuse	# 1711PK 10 Amp Red ATO Type Standard Fuse	# 1712PK 15 Amp Blue ATO Type Standard Fuse	# 1713PK 20 Amp Yellow ATO Type Standard Fuse	# 1714PK 25 Amp White ATO Type Standard Fuse
# 1715PK 20 Amp Cyan ATO Type Standard Fuse	# 1785PK 20 Amp Yellow ATX Type Maxi Fuse	# 1786PK 30 Amp Green ATX Type Maxi Fuse	# 1787PK 40 Amp Orange ATX Type Maxi Fuse	# 1788PK 50 Amp Red ATX Type Maxi Fuse	# 1789PK 60 Amp Blue ATX Type Maxi Fuse

8110 (Plastic Tray)
Shipped In a 18 Hole Plastic Tray
Covers ATM, ATO, & ATX Style Fuses
Contains 18 Different Sizes
126 Total Pcs.
ATM, ATO, ATX Blade Fuse Assortment
Sold Each



# 8112 Phillips Trim Screw Assortment					
# 5765 8 x 1/2" 7/16" O.D. Washer Phillips Oval Washer Head Bright Zinc Finish Wheel Opening Midg. Takt® Screws	# 6010 8 x 1/2" 7/16" O.D. Washer Phillips Oval Washer Head Black Phosphate Finish Wheel Opening Midg. Takt® Screws	# 6265 8 x 3/4" 7/16" O.D. Washer Phillips Oval Washer Head Black Phosphate Finish Mounting Takt® Screws	# 6267 8 x 1" 7/16" O.D. Washer Phillips Oval Washer Head Black Phosphate Finish Mounting Takt® Screws	# 9256 4.8-1.6 x 15mm 14mm Head O.D. Phillips Truss Head Black Phosphate Finish Sheet Metal Screws	# 9260 6.3-1.81 x 15mm 15mm Head O.D. Phillips Truss Head Black Phosphate Finish Sheet Metal Screws
# 5791 8 x 1/2" 13/32" O.D. Washer Phil. Flat Top Washer Head Black Phosphate Finish Trim Screws	# 5984 8 x 3/4" 13/32" O.D. Washer Phil. Flat Top Washer Head Black Phosphate Finish Trim Screws	# 5989 8 x 1" 13/32" O.D. Washer Phil. Flat Top Washer Head Black Phosphate Finish Trim Screws	# 5990 8 x 1 1/4" 13/32" O.D. Washer Phil. Flat Top Washer Head Black Phosphate Finish Trim Screws	# 9497 10 x 3/4" 15/32" O.D. Washer Phil. Flat Top Washer Head Black Phosphate Finish Trim Screws	# 9498 10 x 1" 15/32" O.D. Washer Phil. Flat Top Washer Head Black Phosphate Finish Trim Screws
# 2970 8 x 3/4" 1/2" O.D. Washer Phil. Flat Top Washer Head Black Phosphate Finish Trim Screws	# 2975 8 x 1" 1/2" O.D. Washer Phil. Flat Top Washer Head Black Phosphate Finish Trim Screws	# 9145 10 x 3/4" 1/2" O.D. Washer Phil. Flat Top Washer Head Black Phosphate Finish Trim Screws	# 9146 10 x 1" 1/2" O.D. Washer Phil. Flat Top Washer Head Black Phosphate Finish Trim Screws	# 1795 8 x 3/4" 13/32" O.D. Washer Phil. Flat Top Washer Head Bright Zinc Finish Trim Screws	# 1796 8 x 1" 13/32" O.D. Washer Phil. Flat Top Washer Head Bright Zinc Finish Trim Screws

8112 (Plastic Tray)
 Shipped In a 18 Hole Plastic Tray
 Covers Black & Zinc Phillips
 Washer Head Trim Screws
 Contains 18 Different Sizes
 255 Total Pcs.
 Phillips Trim Screw Assortment
 Sold Each















# 8115 Door Trim Panel Retainer Assortment					
# 1646 Natural Nylon Door Trim Panel Retainers	# 9339 White Nylon Door Trim Panel Retainers	# 4020 Natural Nylon Door Trim Panel Retainers	# 592 Natural Nylon Door Trim Panel Retainers	# 9242 Natural Nylon Door Trim Panel Retainers	# 5264 White Nylon Door Trim Panel Retainers
# 1807 Natural Nylon Door Trim Panel Retainers	# 9368 Natural Nylon Door Trim Panel Retainers	# 1575 Black Nylon Door Trim Panel Retainers	# 2112 Black Nylon Door Trim Panel Retainers	# 1742 Natural Nylon Door Trim Panel Retainers	# 9373 Black Nylon Door Trim Panel Retainers

8115 (Plastic Tray)
 Shipped In a 12 Hole Plastic Tray
 Covers G.M., Ford & AMC
 Model Cars & Trucks
 Contains 12 Different Sizes
 120 Total Pcs.
 Panel Retainer Assortment
 Sold Each









8115R (Refill Kit)
 Shipped In a 8" x 10" Plastic Bag
 Sold Each



# 8116 G.M. Door Panel Pins & Grommets Assortment					
 19.5mm Top Head 30.4mm Pin Length Yellow Nylon Door Panel Pins Use with # 10478 & 10476	 19.5mm Top Head 36.4mm Pin Length Green Nylon Door Panel Pins Use with # 10478	 19.5mm Top Head 28.3mm Pin Length Black Nylon Door Panel Pins Use with # 10476	 19.5mm Top Head 28.3mm Pin Length White Nylon Door Panel Pins Use with # 10476	 12mm Top Head 26.5mm Pin Length White Nylon Door Panel Pins Use with # 10476	 19.5mm Top Head 30.4mm Pin Length Yellow Nylon Door Panel Pins Use with # 10478 & 10476
 9mm Hole Size Door Panel Nuts w/Sealer Use with # 10470, 10471	 9mm Hole Size Yellow Nylon Door Panel Nuts w/Sealer Use with # 10470, 10471	 9mm Hole Size White Nylon Door Panel Nuts w/Sealer Use with # 10470, 10472, 10473 & 10474	 9mm Hole Size White Nylon Door Panel Nuts w/Sealer Use with # 10470, 10472, 10473 & 10474	 9mm Hole Size White Nylon Door Panel Nuts w/Sealer Use with # 10470, 10472, 10473 & 10474	 9mm Hole Size White Nylon Door Panel Nuts w/Sealer Use with # 10470, 10472, 10473 & 10474

8116 (Plastic Tray)
 Shipped In a 12 Hole Plastic Tray
 Used on G.M. Cars & Trucks
 Contains 6 Different Sizes
 120 Total Pcs.
 Door Trim Panel Retainer Assortment
 Sold Each



# 8117 Shield Retainer Assortment					
 1/4" (6.3mm) Hole Size Panel Range: .095" - .540" Black Nylon Shield Retainers	 5/16" (7mm) Hole Size Panel Range: .125" - .310" Black Nylon Shield Retainers	 5/16" (7.8mm) Hole Size Panel Range: .078" - .490" Black Nylon Shield Retainers	 23/64" (9mm) Hole Size Panel Range: .060" - .510" Black Nylon Shield Retainers	 3/8" (9.5mm) Hole Size Panel Range: .115" - .565" Black Nylon Shield Retainers	 23/64" (10mm) Hole Size Panel Range: .040" - .787" Black Nylon Shield Retainers



8117 (Plastic Tray)
 Shipped In a 6 Hole Plastic Tray
 Covers 6.3mm to 10mm Hole Size
 Black Nylon
 Contains 6 Different Sizes
 210 Total Pcs.
 Shield Retainer Assortment
 Sold Each



# 8118 Chrysler Door Panel Assortment					
10467	10466	10464	10465	10494	10477
9mm Top Head Dia. 19mm Flange Dia. White Nylon Door Panel Nut. Use with # 10466.	13mm Top Head Dia. 23mm Flange Dia. White Nylon Door Panel Retainer Use with # 10467.	9.5mm Hole size 15mm Top Head Dia. 14mm Flange Dia. Yellow & White Nylon Door Panel Retainer	9.5mm Hole size 15mm Top Head Dia. 18mm Flange Dia. Gray & White Nylon Door Panel Retainer	9mm Hole size 16mm Top Head Dia. 15.4mm Flange Dia. White Nylon Door Panel Retainer	12.7mm Hole size 16mm Top Head Dia. 25mm Flange Dia. Natural Nylon Door Panel Retainer

8118 (Plastic Tray)
 Shipped In a 6 Hole Plastic Tray
 Covers Chrysler Cars & Trucks
 Contains 6 Different Sizes
 115 Total Pcs.
 Door Trim Panel Retainer Assortment
 Sold Each



# 8119 Shield & Push Type Retainer Assortment					
1/4" (6.3mm) Hole Size Panel Range: 595" - 549" Black Nylon Shield Retainers	5/16" (7mm) Hole Size Panel Range: 125" - 318" Black Nylon Shield Retainers	5/16" (7.8mm) Hole Size Panel Range: 978" - 498" Black Nylon Shield Retainers	23/64" (9mm) Hole Size Panel Range: 365" - 515" Black Nylon Shield Retainers	3/8" (9.5mm) Hole Size Panel Range: 115" - 555" Black Nylon Shield Retainers	23/64" (10mm) Hole Size Panel Range: 348" - 787" Black Nylon Shield Retainers
1/4" (6.3mm) Hole Size Panel Range: 916" Black Nylon Mud Skirt Blind Rivets	5/16" (8mm) Hole Size Head Diameter: 20mm Stem Length: 11mm Black Nylon Front Fender Push-Type Retainers	5/16" (8mm) Hole Size Head Diameter: 20mm Stem Length: 20mm Black Nylon Air Baffle To Under Carriage Push-Type Retainers	23/64" (9mm) Hole Size Head Diameter: 18 mm Stem Length: 28 mm Black Nylon Rear Bumper Cover Push-Type Retainers	23/64" (10mm) Hole Size Head Diameter: 20mm Stem Length: 30mm Black Nylon Push-Type Retainers	23/64" (10mm) Hole Size Head Diameter: 20mm Stem Length: 18mm Black Nylon Push-Type Retainers



8119 (Plastic Tray)
 Shipped In a 12 Hole Plastic Tray
 Covers 6.3mm to 10mm Hole Size
 Black Nylon
 Contains 12 Different Sizes
 192 Total Pcs.
 Shield & Push Type Retainer Assortment
 Sold Each



# 8120 Push-Type Retainer Assortment					
# 9559	# 9465	# 2128	# 1860	# 9327	# 9382
6.3mm Hole Size Head Diameter: 15mm Stem Length: 19mm Black Nylon Wheel Opening Moulding Push-Type Retainers	7mm Hole Size Head Diameter: 20mm Stem Length: 8mm Black Nylon Front Fender Liner Push-Type Retainers	8mm Hole Size Head Diameter: 20mm Stem Length: 11mm Black Nylon Front Fender Push-Type Retainers	8mm Hole Size Head Diameter: 20mm Stem Length: 20mm Black Nylon Air Baffle To Under Carriage Push-Type Retainers	9 mm Hole Size Head Diameter: 18 mm Stem Length: 28 mm Black Nylon Rear Bumper Cover Push-Type Retainers	10 mm Hole Size Head Diameter: 20 mm Stem Length: 18 mm Black Nylon Front & Rear Bumper Push-Type Retainers

8120 (Plastic Tray)
 Shipped In a 6 Hole Plastic Tray
 Covers G.M., Ford, Chrysler,
 Honda & Toyota
 Contains 6 Different Sizes
 82 Total Pcs.
 Push Type Retainer Assortment
 Sold Each



8120R (Refill Kit)
 Shipped In a 8" x 10" Plastic Bag
 Sold Each



# 8121 Push-Type Retainer Assortment					
# 5675	# 2128	# 1860	# 9327	# 9282	# 9382
1/4" (6.3mm) Hole Size Panel Range: 9/16" Black Nylon Med. Skirt Blind Rivets	5/16" (8mm) Hole Size Head Diameter: 20mm Stem Length: 11mm Black Nylon Front Fender Push-Type Retainers	5/16" (8mm) Hole Size Head Diameter: 20mm Stem Length: 20mm Black Nylon Air Baffle To Under Carriage Push-Type Retainers	23/64" (9mm) Hole Size Head Diameter: 18 mm Stem Length: 28 mm Black Nylon Rear Bumper Cover Push-Type Retainers	23/64" (10mm) Hole Size Head Diameter: 20mm Stem Length: 13mm Black Nylon Push-Type Retainers	23/64" (10mm) Hole Size Head Diameter: 20mm Stem Length: 18mm Black Nylon Push-Type Retainers

8121 (Plastic Tray)
 Shipped In a 6 Hole Plastic Tray
 Covers 6.3mm to 10mm Hole Size
 Black Nylon
 Contains 6 Different Sizes
 175 Total Pcs.
 Push Type Retainer Assortment
 Sold Each



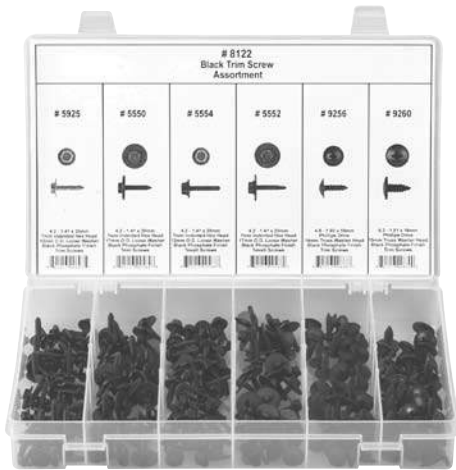

# 8122 Black Trim Screw Assortment					
# 5925	# 5550	# 5554	# 5552	# 9256	# 9260
4.2 - 1.41 x 20mm 7mm Indented Hex Head 12mm O.D. Loose Washer Black Phosphate Finish Trim Screws	4.2 - 1.41 x 20mm 7mm Indented Hex Head 17mm O.D. Loose Washer Black Phosphate Finish Trim Screws	4.2 - 1.41 x 20mm 7mm Indented Hex Head 12mm O.D. Loose Washer Black Phosphate Finish Tek® Screws	4.2 - 1.41 x 20mm 7mm Indented Hex Head 17mm O.D. Loose Washer Black Phosphate Finish Tek® Screws	4.8 - 1.55 x 16mm Phillips Drive 14mm Truss Washer Head Black Phosphate Finish Trim Screws	6.3 - 1.81 x 16mm Phillips Drive 15mm Truss Washer Head Black Phosphate Finish Trim Screws













8122 (Plastic Tray)
 Shipped In a 6 Hole Plastic Tray
 Hex Head & Phillips Drive
 Black Finish
 Contains 6 Different Sizes
 210 Total Pcs.
 Black Trim Screw Assortment
 Sold Each



# 8123 Phillips Pan Head Black Finish Sheet Metal Screw Assortment					
10101	10102	10103	10104	1623	1624
6 x 1/2" Phillips Pan Head Black Finish Sheet Metal Screws O.E.M. # N/A	6 x 3/4" Phillips Pan Head Black Finish Sheet Metal Screws O.E.M. # N/A	6 x 1" Phillips Pan Head Black Finish Sheet Metal Screws O.E.M. # N/A	6 x 1 1/4" Phillips Pan Head Black Finish Sheet Metal Screws O.E.M. # N/A	8 x 1/2" Phillips Pan Head Black Finish Sheet Metal Screws O.E.M. # N/A	8 x 3/4" Phillips Pan Head Black Finish Sheet Metal Screws O.E.M. # N/A
1625	1626	1722	1723	1724	1726
8 x 1" Phillips Pan Head Black Finish Sheet Metal Screws O.E.M. # N/A	8 x 1 1/2" Phillips Pan Head Black Finish Sheet Metal Screws O.E.M. # N/A	10 x 1/2" Phillips Pan Head Black Finish Sheet Metal Screws O.E.M. # N/A	10 x 3/4" Phillips Pan Head Black Finish Sheet Metal Screws O.E.M. # N/A	10 x 1" Phillips Pan Head Black Finish Sheet Metal Screws O.E.M. # N/A	10 x 1 1/2" Phillips Pan Head Black Finish Sheet Metal Screws O.E.M. # N/A

























8123 (Plastic Tray)
 Shipped In a 12 Hole Plastic Tray
 Phillips Pan Head
 Black Finish
 Contains 12 Different Sizes
 420 Total Pcs.
 Black Sheet Metal Screw Assortment
 Sold Each



# 8125 Nylon Pop Rivet Assortment					
# 5769	# 1195	# 9054	# 1390	# 5775	# 5770
					
3/16" (5mm) Hole Size Panel Range: 1/8" - 15/64" Flange Size: 15/32" Black Nylon Pop Rivets	3/16" (5mm) Hole Size Panel Range: 15/64" - 25/64" Flange Size: 15/32" Black Nylon Pop Rivets	1/4" (6.3mm) Hole Size Panel Range: 3/32" - 3/16" Flange Size: 1/2" Black Nylon Pop Rivets	1/4" (6.3mm) Hole Size Panel Range: 5/32" - 13/32" Flange Size: 1/2" Black Nylon Pop Rivets	17/64" (6.6mm) Hole Size Panel Range: 3/32" - 3/16" Flange Size: 45/64" Black Nylon Pop Rivets	1/4" (6.3mm) Hole Size Panel Range: 5/32" - 13/32" Flange Size: 43/64" Black Nylon Pop Rivets
					

8125 (Plastic Tray)
 Shipped In a 6 Hole Plastic Tray
 Covers G.M., Ford & Chrysler
 Black Nylon
 Contains 6 Different Sizes
 115 Total Pcs.
 Nylon Pop Rivets Assortment
 Sold Each



# 8126 Hex Washer Head Tek Screw Assortment					
# 1077	# 1078	# 9791	# 9841	# 9346	# 1080
					
8 x 1/2" #2 Tek Point 1/4" Hex Head Indented Hex Washer Head Zinc Finish Tek® Screws	8 x 3/4" #2 Tek Point 1/4" Hex Head Indented Hex Washer Head Zinc Finish Tek® Screws	8 x 1" #2 Tek Point 1/4" Hex Head Indented Hex Washer Head Zinc Finish Tek® Screws	10 x 1/2" #2 Tek Point 5/16" Hex Head Indented Hex Washer Head Zinc Finish Tek® Screws	10 x 3/4" #2 Tek Point 5/16" Hex Head Indented Hex Washer Head Zinc Finish Tek® Screws	10 x 1" #2 Tek Point 5/16" Hex Head Indented Hex Washer Head Zinc Finish Tek® Screws
					
# 9794	# 9843	# 9795	# 1970	# 1971	# 9842
					
10 x 1 1/2" #3 Tek Point 5/16" Hex Head Indented Hex Washer Head Zinc Finish Tek® Screws	12 x 3/4" #3 Tek Point 5/16" Hex Head Indented Hex Washer Head Zinc Finish Tek® Screws	12 x 1" #3 Tek Point 5/16" Hex Head Indented Hex Washer Head Zinc Finish Tek® Screws	14 x 3/4" #3 Tek Point 3/8" Hex Head Indented Hex Washer Head Zinc Finish Tek® Screws	14 x 1" #3 Tek Point 3/8" Hex Head Indented Hex Washer Head Zinc Finish Tek® Screws	14 x 1 1/2" #2 Tek Point 3/8" Hex Head Indented Hex Washer Head Zinc Finish Tek® Screws
					

8126 (Plastic Tray)
 Shipped In a 12 Hole Plastic Tray
 Hex Washer Head Tek Screws
 Bright Zinc Finish
 Contains 12 Different Sizes
 295 Total Pcs.
 Hex Washer Head Tek Screw Assortment
 Sold Each



# 8127 Bright Zinc Finish Phillips Pan & Hex Washer Head Tek Screw Assortment					
5765 8 x 3/2" 13/32" O.D. Washer Phillips Oval Washer Head	1964 8 x 1/2" #2 Tek Point Phillips Pan Head	1965 8 x 3/4" #2 Tek Point Phillips Pan Head	1966 8 x 1" #2 Tek Point Phillips Pan Head	1967 10 x 3/4" #2 Tek Point Phillips Pan Head	1968 10 x 3/4" #2 Tek Point Phillips Pan Head
1969 10 x 1" #2 Tek Point Phillips Pan Head	1077 8 x 1 1/2" - 1/8" Hex Head #2 Tek Point Indented Hex Washer Head	1078 8 x 3/4" - 1/8" Hex Head #2 Tek Point Indented Hex Washer Head	9841 10 x 1 1/2" - 5/16" Hex Head #2 Tek Point Indented Hex Washer Head	9346 10 x 3/4" - 5/16" Hex Head #2 Tek Point Indented Hex Washer Head	1080 10 x 1" - 5/16" Hex Head #2 Tek Point Indented Hex Washer Head
9843 12 x 3/4" - 5/16" Hex Head #3 Tek Point Indented Hex Washer Head	9795 12 x 1" - 5/16" Hex Head #3 Tek Point Indented Hex Washer Head	1970 14 x 3/4" - 3/8" Hex Head #3 Tek Point Indented Hex Washer Head	1971 14 x 1" - 3/8" Hex Head #3 Tek Point Indented Hex Washer Head	9797 14 x 1 1/4" - 3/8" Hex Head #3 Tek Point Indented Hex Washer Head	9842 14 x 1 1/2" - 3/8" Hex Head #3 Tek Point Indented Hex Washer Head

8127 (Plastic Tray)
Shipped In a 18 Hole Plastic Tray
Phillips Pan & Hex Washer Head
Black & Bright Zinc Finish
Contains 18 Different Sizes
425 Total Pcs.
Tek Screw Assortment
Sold Each



# 8130 Phillips Oval Head Screw Assortment					
# 6400 8 x 1 1/2" # 6 Head Phillips Oval Head Chrome Finish Sheet Metal Screws	# 6401 8 x 3/4" # 6 Head Phillips Oval Head Chrome Finish Sheet Metal Screws	# 6402 8 x 1" # 6 Head Phillips Oval Head Chrome Finish Sheet Metal Screws	# 6404 8 x 1 1/2" # 6 Head Phillips Oval Head Chrome Finish Sheet Metal Screws	# 6410 10 x 3/4" # 8 Head Phillips Oval Head Chrome Finish Sheet Metal Screws	# 6411 10 x 1" # 8 Head Phillips Oval Head Chrome Finish Sheet Metal Screws
# 9479 8 x 1/2" # 6 Head Phillips Oval Head Black Finish Sheet Metal Screws	# 1184 8 x 3/4" # 6 Head Phillips Oval Head Black Finish Sheet Metal Screws	# 1186 8 x 1" # 6 Head Phillips Oval Head Black Finish Sheet Metal Screws	# 1188 8 x 1 1/2" # 6 Head Phillips Oval Head Black Finish Sheet Metal Screws	# 9480 10 x 3/4" # 8 Head Phillips Oval Head Black Finish Sheet Metal Screws	# 9252 10 x 1" # 8 Head Phillips Oval Head Black Finish Sheet Metal Screws

8130 (Plastic Tray)
Shipped In a 12 Hole Plastic Tray
Phillips Oval Head
Black & Chrome Finish
Contains 12 Different Sizes
380 Total Pcs.
Phillips Oval Head Screw Assortment
Sold Each



8130R (Refill Kit)
Shipped In a 8" x 10" Plastic Bag
Sold Each



# 8131 Bright Zinc Finish Cotter Pin Assortment					
 4067 1/16" x 2" Zinc Finish Hammerlock Type Cotter Pins	 4074 3/32" x 2" Zinc Finish Hammerlock Type Cotter Pins	 4086 1/8" x 1" Zinc Finish Hammerlock Type Cotter Pins	 4088 1/8" x 1 1/2" Zinc Finish Hammerlock Type Cotter Pins	 4090 1/8" x 2" Zinc Finish Hammerlock Type Cotter Pins	 4094 5/32" x 1" Zinc Finish Hammerlock Type Cotter Pins
 4096 5/32" x 1 1/2" Zinc Finish Hammerlock Type Cotter Pins	 4098 5/32" x 2" Zinc Finish Hammerlock Type Cotter Pins	 4103 3/16" x 1" Zinc Finish Hammerlock Type Cotter Pins	 4105 3/16" x 1 1/2" Zinc Finish Hammerlock Type Cotter Pins	 4107 3/16" x 2" Zinc Finish Hammerlock Type Cotter Pins	 4114 1/4" x 1 1/2" Zinc Finish Hammerlock Type Cotter Pins

8131 (Plastic Tray)
 Shipped In a 12 Hole Plastic Tray
 Hammerlock Type
 Bright Zinc Finish
 Contains 12 Different Sizes
 375 Total Pcs.
 Cotter Pin Assortment
 Sold Each



# 8135 Shield Retainer Assortment					
 # JL-32 3/16" (4.5mm) Hole Size Panel Range: .125" - .310" Black Nylon Shield Retainers	 # 1583 3/16" (5mm) Hole Size Panel Range: .090" - .576" Black Nylon Shield Retainers	 # 5506 1/4" (6.4mm) Hole Size Panel Range: .110" - .469" Black Nylon Shield Retainers	 # 5625 1/4" (6.4mm) Hole Size Panel Range: .095" - .540" Black Nylon Shield Retainers	 # 5632 1/4" (6.4mm) Hole Size Panel Range: .070" - .590" Black Nylon Shield Retainers	 # 5627 1/4" (6.4mm) Hole Size Panel Range: .100" - .685" Black Nylon Shield Retainers
 # 9132 9/32" (7.1mm) Hole Size Panel Range: .125" - .310" Black Nylon Shield Retainers	 # JL-33 5/16" (7.8mm) Hole Size Panel Range: .070" - .450" Black Nylon Shield Retainers	 # 5995 5/16" (7.8mm) Hole Size Panel Range: .060" - 1.025" Black Nylon Shield Retainers	 # 5643 23/64" (9mm) Hole Size Panel Range: .060" - .510" Black Nylon Shield Retainers	 # 5710 3/8" (9.5mm) Hole Size Panel Range: .115" - .565" Black Nylon Shield Retainers	 # 5648 25/64" (10mm) Hole Size Panel Range: .040" - .787" Black Nylon Shield Retainers

8135 (Plastic Tray)
 Shipped In a 12 Hole Plastic Tray
 Covers 3/16" to 25/64" Hole Size
 Black Nylon
 Contains 12 Different Sizes
 168 Total Pcs.
 Shield Retainer Assortment
 Sold Each



8135R (Refill Kit)
 Shipped In a 8" x 10" plastic bag
 Sold Each

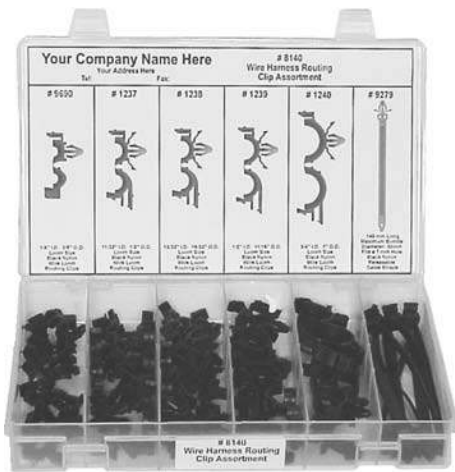

# 8140 Wire Harness Routing Clip Assortment					
# 9690	# 1237	# 1238	# 1239	# 1240	# 9279
1/4" I.D. 3/8" O.D. Loom Size Black Nylon Wire Loom Routing Clips	11/32" I.D. 1/2" O.D. Loom Size Black Nylon Wire Loom Routing Clips	13/32" I.D. 19/32" O.D. Loom Size Black Nylon Wire Loom Routing Clips	1/2" I.D. 11/16" O.D. Loom Size Black Nylon Wire Loom Routing Clips	3/4" I.D. 1" O.D. Loom Size Black Nylon Wire Loom Routing Clips	140 mm Long Maximum Bundle Diameter: 30mm Fits a 7 mm Hole Black Nylon Releasable Cable Straps

8140 (Plastic Tray)
Shipped In a 6 Hole Plastic Tray
Covers 3/8" to 3/4" Loom
Black Nylon
Contains 6 Different Sizes
54 Total Pcs.
Wire Routing Clip Assortment
Sold Each



8140R (Refill Kit)
Shipped In a 8" x 10" plastic bag
Sold Each



# 8145 Thread Cutting Nuts & Push On Retainer Assortment					
# 989	# 991	# 1621	# 3010	# 1276	# 1044
1/4" Bolt Size 25/32" Flange O.D. Zinc Finish Push On Retainers	1/2" Bolt Size 1 1/16" O.D. Black Finish Push On Retainers	6 - 1.00 mm Screw Size 17 mm Flange O.D. Black Finish Push On Retainers	8 - 1.25 mm Screw Size 24 mm Flange O.D. Dacromet Finish Push On Retainers	10 - 1.50 mm Screw Size 24 mm Flange O.D. Dacromet Finish Push On Retainers	12-1.75mm Bolt Size 21mm Flange O.D. Black Finish Push On Retainers
# 265	# 263	# 9226	# 856	# 1042	# 1622
1/8" Stud Size 5/16" Hex Size 17/32" Flange Zinc Finish Thread Cutting Nuts	3/16" Stud Size 3/8" Hex Size 5/8" Flange Zinc Finish Thread Cutting Nuts	1/4" Stud Size 7/16" Hex Size 11/16" Flange Zinc Finish Thread Cutting Nuts	5/16" Stud Size 1/2" Hex Size 7/8" Flange Zinc Finish Thread Cutting Nuts	6.3 mm Stud Size 11mm Hex Size 18mm Flange Zinc Finish Thread Cutting Nuts	8mm Stud Size 13mm Hex Size 20mm Flange Zinc Finish Thread Cutting Nuts

8145 (Plastic Tray)
Shipped In a 12 Hole Plastic Tray
Thread Cutting Nut &
Push on Retainers
Contains 12 Different Sizes
245 Total Pcs.
Thread Cutting Nut & Push on
Retainer Assortment
Sold Each



8145R (Refill Kit)
Shipped In a 8" x 10" plastic bag
Sold Each



# 8146 Ford Door Trim Panel Retainer Assortment					
# 2112 17/64" (7mm) Hole Size Top Head Dia.: 12.5mm Stem Length: 19mm Black Nylon Door Trim Panel Retainers	# 1558 17/64" (7mm) Hole Size Top Head Dia.: 13.2mm Stem Length: 19mm Natural Nylon Door Trim Panel Retainers	# 9514 17/64" (7mm) Hole Size Top Head Dia.: 13mm Stem Length: 22mm Natural Nylon Door Trim Panel Retainers	# 1024 17/64" (7mm) Hole Size Top Head Dia.: 20mm Stem Length: 19.5mm Natural Nylon Door Trim Panel Retainers	# 1648 17/64" (7mm) Hole Size Top Head Dia.: 20mm Stem Length: 24mm Natural Nylon Door Trim Panel Retainers	# 10544 17/64" (7mm) Hole Size Top Head Dia.: 15mm Stem Length: 13mm Natural Nylon Door Trim Panel Retainers
# 9372 5/16" (8mm) Hole Size Top Head Dia.: 1/2" Stem Length: 21/32" Natural Nylon Door Trim Panel Retainers	# 10098 5/16" (7.9mm) Hole Size Top Head Dia.: 1/2" Stem Length: 3/4" Yellow Nylon Door Trim Panel Retainers	# 1575 5/16" (8mm) Hole Size Top Head Dia.: 1/2" Stem Length: 3/4" Black Nylon Door Trim Panel Retainers	# 1742 5/16" (8mm) Hole Size Top Head Dia.: 1/2" Stem Length: 1" Natural Nylon Door Trim Panel Retainers	# 10612 (8mm) Hole Size Top Head Dia.: 16mm Stem Length: 17mm White Nylon With Sealer Door Trim Panel Retainers	# 10667 (10mm) Hole Size Top Head Dia.: 15mm Stem Length: 19.5mm Natural Nylon Door Trim Panel Retainers

8146 (Plastic Tray)
 Shipped In a 12 Hole Plastic Tray
 Covers Ford Cars & Trucks
 Nylon
 Contains 12 Different Sizes
 116 Total Pcs.
 Door Trim Panel Retainer Assortment
 Sold Each



# 8150 Weatherstrip Retainer Assortment					
# 1991 4.5mm Hole Size Stem Length: 11mm Head Dia.: 4.8 x 12.5mm Black Nylon Weatherstrip Retainers	# 9264 5mm Hole Size Stem Length: 14.5mm Head Dia.: 5.5 x 14.5mm Black Nylon Weatherstrip Retainers	# 2016 5mm Hole Size Stem Length: 15mm Head Dia.: 6.5 x 16.5mm White Nylon Weatherstrip Retainers	# 9560 5mm Hole Size Stem Length: 10mm Head Dia.: 7 x 16mm White Nylon Weatherstrip Retainers	# 9208 6mm Hole Size Stem Length: 10mm Head Dia.: 5 x 15mm Orange Nylon Weatherstrip Retainers	# 5602 4mm Hole Size Head Diameter: 9mm Stem Length: 10.7mm Black Nylon Retaining Clips
# 5605 4.5mm Hole Size Head Diameter: 11mm Stem Length: 8.3mm Black Nylon Weatherstrip Retainers	# JL-32 4.5mm Hole Size Head Diameter: 9.1mm Stem Length: 13.5mm Black Nylon Weatherstrip Retainers	# 8172 4.5mm Hole Size Head Diameter: 11mm Stem Length: 16mm Black Nylon Retaining Clips	# 1996 5mm Hole Size Head Diameter: 13mm Stem Length: 11mm Black Nylon Retaining Clips	# 5609 5.3mm Hole Size Head Diameter: 10mm Stem Length: 15.5mm Black Nylon Retaining Clips	# 9262 6mm Hole Size Head Diameter: 12mm Stem Length: 9mm Black Nylon Retaining Clips

8150 (Plastic Tray)
 Shipped In a 12 Hole Plastic Tray
 Covers G.M., Ford, Chrysler,
 Honda & Toyota
 Contains 12 Different Sizes
 300 Total Pcs.
 Weatherstrip Retainer Assortment
 Sold Each



8150R (Refill Kit)
 Shipped In a 8" x 10" plastic bag
 Sold Each



# 8155 Stainless Steel Capped Bumper Bolt Assortment					
# 240	# 855	# 9314	# 233	# 231	# 9275
5/16-18 x 1" 3/4" Head Diameter Round Style Head Stainless Steel Capped Bumper Bolts	3/8-16 X 1" 7/8" Head Diameter Fan Head Stainless Steel Capped Bumper Bolts	3/8-16 x 1 1/4" 7/8" Head Diameter Round Style Head Stainless Steel Capped Bumper Bolts	7/16-14 x 1 1/2" 2 3/32" Head Diameter Round Style Head Stainless Steel Capped Bumper Bolts	1/2-13 x 1 1/2" 1 3/32" Head Diameter Round Style Head Stainless Steel Capped Bumper Bolts	8-1.25 x 25mm 12.7mm Head Diameter Pan Head Stainless Steel Capped Bumper Bolts

8155 (Plastic Tray)
 Shipped In a 6 Hole Plastic Tray
 Covers 5/16" to 1/2"
 Stainless Steel Capped
 Contains 6 Different Sizes
 53 Total Pcs.
 Bumper Bolt Assortment
 Sold Each



# 8161 Universal Door Pin & Bushing Assortment					
9164		9825			
11/32" Pin Dia. 5 1/4" Length Stainless Steel Door Hinge Pins		11/32" Dia. Length: 4 1/8" Hs. O.D.: 3/4" Door Hinge Pins			
3/45" I.D. .485" O.D. 3/85" HL Hinge Pin Bushings Use with # 9164PK	3/45" I.D. 475" O.D. 295" HL Hinge Pin Bushings	3/8" Shaft Dia. 355 Groove Dia. 375 Groove H. Blaze Finish 1" Slips	3/45" I.D. 415" O.D. 255" HL Hinge Pin Bushings	11/32" Dia. Length: 3 3/8" Hs. O.D.: 9/16" Door Hinge Pins	11/32" Dia. Length: 3 3/8" Hs. O.D.: 9/16" Door Hinge Pins
3/85" I.D. 315" O.D. 345" HL Hinge Pin Bushings Use with # 9164PK	3/48" I.D. 475" O.D. 295" HL Hinge Pin Bushings	3/45" I.D. 485" O.D. 305" HL Hinge Pin Bushings	11/32" Dia. 3 1/2" Long 9/16" Hs. Dia. Door Hinge Pins	11/32" Dia. Length: 4" Hs. O.D.: 7/16" Door Hinge Pins	11/32" Dia. Length: 4 1/16" Hs. O.D.: 3/16" Door Hinge Pins

8161 (Plastic Tray)
 Shipped In a 10 Hole Plastic Tray
 Covers G.M. & Ford
 Includes Bushings & Retainers
 Contains 6 Different Sizes
 86 Total Pcs.
 Door Pin & Bushing Assortment
 Sold Each



# 8165 Flush Type Hole Plug Assortment					
# 9812 1/4" Hole Size Black Flush Type Hole Plugs	# 1302 3/8" Hole Size Black Flush Type Hole Plugs	# 1091 1/2" Hole Size Black Flush Type Hole Plugs	# 1379 3/4" Hole Size Black Flush Type Hole Plugs	# 2051 1/4" Hole Size Black Flush Type Locking Hole Plugs	# 2053 3/8" Hole Size Black Flush Type Locking Hole Plugs
# 9827 1/4" Hole Size White Flush Type Hole Plugs	# 9828 3/8" Hole Size White Flush Type Hole Plugs	# 9829 1/2" Hole Size White Flush Type Hole Plugs	# 9830 3/4" Hole Size White Flush Type Hole Plugs	# 2225 1/2" Hole Size Black Flush Type Locking Hole Plugs	# 9831 3/4" Hole Size Black Flush Type Locking Hole Plugs



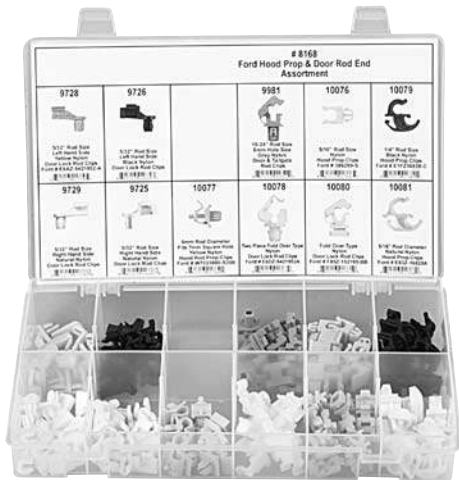





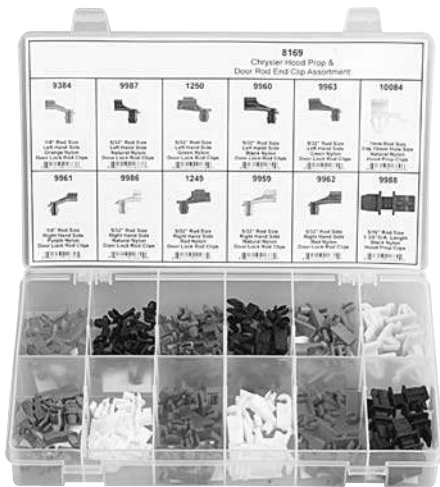



8165 (Plastic Tray)
Shipped In a 12 Hole Plastic Tray
Covers All Types Of Flush Hole Plugs
White & Black Nylon
Contains 12 Different Sizes
349 Total Pcs.
Flush Type Hole Plug Assortment
Sold Each



# 8168 Ford Hood Prop & Door Rod End Assortment					
9728 5/32" Rod Size Left Hand Side Yellow Nylon Door Lock Rod Clips Ford # E6AZ-5421952-A	9726 5/32" Rod Size Left Hand Side Black Nylon Door Lock Rod Clips	9981 10-24" Rod Size Gray Nylon Door & Tailgate Rod Clips	10076 5/16" Rod Size Nylon Hood Prop Clips Ford # 386299-S	10079 1/4" Rod Size Black Nylon Hood Prop Clips Ford # E1FZ16828-C	10081 5/16" Rod Diameter Natural Nylon Hood Prop Clips Ford # E83Z-16828A
9729 5/32" Rod Size Right Hand Side Natural Nylon Door Lock Rod Clips	9725 5/32" Rod Size Right Hand Side Natural Nylon Door Lock Rod Clips	10077 8mm Rod Diameter Fits 7mm Square Hole Yellow Nylon Hood Rod Prop Clips Ford # W70Z386B-S300	10078 Two Piece Fold Over Type Nylon Door Lock Rod Clips Ford # E6DZ-5421952A	10080 Fold Over Type Nylon Door Lock Rod Clips Ford # F85Z-152195-BB	10081 5/16" Rod Diameter Natural Nylon Hood Prop Clips Ford # E83Z-16828A







8168 (Plastic Tray)
Shipped In a 12 Hole Plastic Tray
Covers Ford Cars & Trucks
All Nylon
Contains 11 Different Sizes
100 Total Pcs.
Hood Prop & Rod End Assortment
Sold Each



8169 Chrysler Hood Prop & Door Rod End Clip Assortment					
 9384 1/8" Rod Size Left Hand Side Orange Nylon Door Lock Rod Clips	 9987 5/32" Rod Size Left Hand Side Natural Nylon Door Lock Rod Clips	 1250 5/32" Rod Size Left Hand Side Green Nylon Door Lock Rod Clips	 9960 5/32" Rod Size Left Hand Side Black Nylon Door Lock Rod Clips	 9963 5/32" Rod Size Left Hand Side Red Nylon Door Lock Rod Clips	 10084 Fits 10mm Hole Size Natural Nylon Hood Prop Clips
 9961 1/8" Rod Size Right Hand Side Purple Nylon Door Lock Rod Clips	 9986 5/32" Rod Size Right Hand Side Natural Nylon Door Lock Rod Clips	 1249 5/32" Rod Size Right Hand Side Red Nylon Door Lock Rod Clips	 9959 5/32" Rod Size Right Hand Side Natural Nylon Door Lock Rod Clips	 9962 5/32" Rod Size Right Hand Side Red Nylon Door Lock Rod Clips	 9988 5/16" Rod Size 1 3/8" O.A. Length Black Nylon Hood Prop Clips

8169 (Plastic Tray)
 Shipped In a 12 Hole Plastic Tray
 Covers Chrysler Cars & Trucks
 All Nylon
 Contains 12 Different Sizes
 131 Total Pcs.
 Hood Prop & Rod End Assortment
 Sold Each



8170 Window Guide Retainers Assortment					
 # 1568 Black Nylon Front Door Glass Window Guide Retainers	 # 1563 Upper Part of Glass Black Nylon Front Door Glass Window Guide Retainers	 # 1562 Black Nylon Front & Rear Door Glass Window Guide Retainers	 # 1566 Rear of Glass Black Nylon Front Door Glass Window Guide Retainers	 # 9421 Front of Glass 4mm Thick Black Nylon Front Door Glass Window Guide Retainers	 # 1681 Black Nylon Front Door Glass Window Guide Retainers

8170 (Plastic Tray)
 Shipped In a 6 Hole Plastic Tray
 Covers G.M. Cars
 Black Nylon
 Contains 6 Different Sizes
 42 Total Pcs.
 Window Guide Assortment
 Sold Each

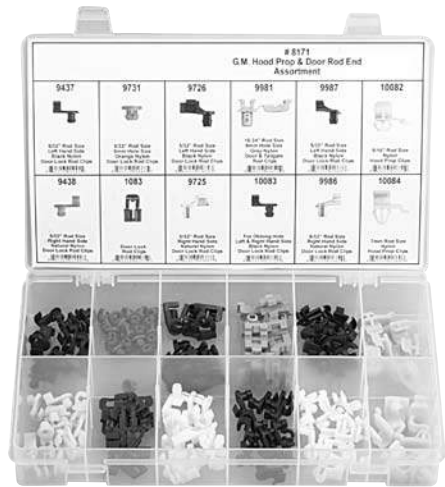

# 8171 G.M. Hood Prop & Door Rod End Assortment					
 5/32" Rod Size Left Hand Side Black Nylon Door Lock Rod Clips	 5/32" Rod Size 8mm Hole Size Orange Nylon Door Lock Rod Clips	 5/32" Rod Size Left Hand Side Black Nylon Door Lock Rod Clips	 10-24" Rod Size 8mm Hole Size Yellow Nylon Door & Tailgate Rod Clips	 5/32" Rod Size Left Hand Side Black Nylon Door Lock Rod Clips	 5/16" Rod Size Nylon Hood Prop Clips
 5/32" Rod Size Right Hand Side Natural Nylon Door Lock Rod Clips	 Door Lock Rod Clips	 5/32" Rod Size Right Hand Side Natural Nylon Door Lock Rod Clips	 For Oblong Hole Left & Right Hand Side Black Nylon Door Lock Rod Clips	 5/32" Rod Size Right Hand Side Natural Nylon Door Lock Rod Clips	 7mm Rod Size Nylon Hood Prop Clips

8171 (Plastic Tray)
Shipped In a 12 Hole Plastic Tray
Covers G.M. Cars & Trucks
Nylon & Metal Retainers
Contains 12 Different Sizes
137 Total Pcs.
Hood Prop & Rod End Assortment
Sold Each



# 8173 Toyota & Lexus Moulding Clip Assortment					
 Hole Size: 9mm Head Diameter: 17mm Red Nylon Fender Moulding Clips	 Hole Size: 9mm Head Diameter: 17mm Yellow Nylon Fender & Wheel Flare Moulding Clip	 Hole Size: 9mm Head Diameter: 17mm Orange Nylon Wheel Flare Moulding Clips With Sealer	 Hole Size: 9mm Head Diameter: 17mm Blue Nylon Fender Moulding Clips	 Hole Size: 9mm Head Diameter: 18mm White Nylon Rocker Panel Moulding Clips	 Hole Size: 10mm Head Diameter: 17mm Blue Nylon Rocker Panel Moulding Clips With Sealer
 Hole Size: 8mm Head Diameter: 18mm Yellow Nylon Fender Moulding Clips With Sealer	 Hole Size: 8mm Head Diameter: 18mm Gray Nylon Fender Moulding Clips With Sealer	 Hole Size: 9mm Head Diameter: 18mm Pink Nylon Moulding Clips With Sealer	 Hole Size: 12mm Head Diameter: 18mm Blue Nylon Rocker Panel Moulding Clips	 Hole Size: 9 x 12mm Head Diameter: 20mm White Nylon Garnish Moulding Clips	



8173 (Plastic Tray)
Shipped In a 12 Hole Plastic Tray
Covers 8mm to 10mm Hole Size
Covers Toyota & Lexus
Contains 11 Different Sizes
154 Total Pcs.
Moulding Clip Assortment
Sold Each



# 8174 Toyota Retainer Assortment					
# 9081 9mm Hole Size White Nylon Door Trim Panel Retainers	# 1603 7mm Hole Size Black Nylon Push-Type Retainers	# 9465 7mm Hole Size Black Nylon Front Fender Liner Push-Type Retainers	# 9327 9mm Hole Size Rear Bumper Cover Black Nylon Push-Type Retainers	# 1996 5mm Hole Size Black Nylon Retaining Clips	# 1950 7mm Hole Size Black Nylon Retaining Clips
# 1614 10 Screw Size Fits a 8.5mm Square Hole Natural Nylon Screw Grommets	# 1560 10 Screw Size Natural Nylon Headlamp Bezel & Grille Nuts	# 1576 10 Screw Size Natural Nylon Screw Grommets	# 9591 6 Screw Size 7mm Square Hole Natural Nylon Screw Grommets	# 9912 #12 Screw Size 10mm Square Hole Front & Rear Wheel Fender Liner Screw Grommets	# 1605 1/4" (#14) Screw Size Black Nylon Screw Grommets

8174 (Plastic Tray)
Shipped In a 12 Hole Plastic Tray
Covers Toyota Cars
All Nylon
Contains 12 Different Sizes
146 Total Pcs.
Retainer Assortment
Sold Each



8174R (Refill Kit)
Shipped In a 8" x 10" plastic bag
Sold Each



# 8175 Nissan Retainer Assortment					
# 1756 6mm Square Hole Size Head Size: 8mm x 12mm Stem Length: 8mm Black Nylon Cowl Grille Retainers	# 2028 6mm Hole Size Head Dia.: 16mm Stem Length: 16mm Black Nylon Cowl Panel to Reinf. Plate & Engine Splash Shield Retainers	# 9114 7mm Hole Size Head Diameter: 18mm Stem Length: 11mm Black Nylon Push-Type Retainers	# 1949 6mm Hole Size Head Diameter: 20mm Stem Length: 15mm Black Nylon Front & Rear Bumper Cover Push-Type Retainers	# 9540 8mm Hole Size Head Diameter: 20mm Stem Length: 20mm Black Nylon Push-Type Retainers	# 1975 8mm Hole Size Head Diameter: 16mm Stem Length: 20mm Black Nylon Push-Type Retainers
# 5901 5/16" (8mm) Hole Size Stem Length: 18mm Flange Size: 20mm Black Nylon Inter Fender Shield Blind Rivets	# 9294 10mm Hole Size Head Diameter: 16mm Stem Length: 15mm Black Nylon Push-Type Retainers	# 2153 11mm Hole Size Head Diameter: 22mm Stem Length: 14mm Black Nylon Bumper & Fascia Push-Type Retainers	# 9539 Natural Nylon Door Trim Panel Retainers	# 1634 6mm Hole Size Head Diameter: 14mm Stem Length: 13mm Black Nylon Retaining Clips	# 2025 Stem Length: 9mm Outside Dia.: 38mm Black Nylon Hood Insulation Clips

8175 (Plastic Tray)
Shipped In a 12 Hole Plastic Tray
Covers Nissan Cars
All Nylon
Contains 12 Different Sizes
123 Total Pcs.
Retainer Assortment
Sold Each



8175R (Refill Kit)
Shipped In a 8" x 10" plastic bag
Sold Each



# 8176 Wide Range "U" Nuts Assortment					
# 1350	# 5750	# 5751	# 5752	# 1192	# 5753
8 Screw Size Panel Range: 925" - 150" Center of Hole to Edge: 3/8" Black Phosphate Finish Wide Range "U" Nuts	8 Screw Size Panel Range: 925" - 150" Center of Hole to Edge: 5/8" Black Phosphate Finish Wide Range "U" Nuts	10 Screw Size Panel Range: 925" - 150" Center of Hole to Edge: 3/8" Black Phosphate Finish Wide Range "U" Nuts	10 Screw Size Panel Range: 925" - 150" Center of Hole to Edge: 5/8" Black Phosphate Finish Wide Range "U" Nuts	14 Screw Size Panel Range: 925" - 150" Center of Hole to Edge: 3/8" Black Phosphate Finish Wide Range "U" Nuts	14 Screw Size Panel Range: 925" - 150" Center of Hole to Edge: 5/8" Black Phosphate Finish Wide Range "U" Nuts

8176 (Plastic Tray)
 Shipped In a 6 Hole Plastic Tray
 For #8, 10 & 1/4" Screws
 Short & Long Type
 Contains 6 Different Sizes
 210 Total Pcs.
 "U" Nut Assortment
 Sold Each



# 8177 Honda Retainer Assortment					
# D-123	# D-124	# 9202	# 1973	# 1976	# 9208
16mm Hole Size Stem Length: 27mm Flange Size: 20mm Black Nylon Bumper Fascia Retainers	16mm Hole Size Stem Length: 24mm Flange Size: 20mm Black Nylon Bumper Fascia Retainers	10mm Hole Size Stem Length: 15mm Head Diameter: 20mm Black Nylon Push-Type Retainers	8mm Hole Size Stem Length: 21mm Head Diameter: 18mm Black Nylon Push-Type Retainers	8mm Hole Size Head Diameter: 20mm Stem Length: 9mm Black Nylon Push-Type Retainers	6mm Hole Size Stem Length: 10mm Head Dia.: 5 x 15mm Orange Nylon Weatherstrip Retainers
10mm Hole Size Head Diameter: 20mm Stem Length: 13mm Black Nylon Push-Type Retainers	10mm Hole Size Head Diameter: 25mm Stem Length: 11mm Black Nylon Push-Type Retainers	8mm Hole Size Head Diameter: 20mm Stem Length: 18mm Black Nylon Push-Type Retainers	10mm Hole Size Head Diameter: 20mm Stem Length: 18mm Black Nylon Push-Type Retainers	6mm Hole Size Head Diameter: 12mm Stem Length: 8mm Black Nylon Retaining Clips	7.5mm Hole Size Head Diameter: 20mm Black Nylon Hood Insulation Clips

8177 (Plastic Tray)
 Shipped In a 12 Hole Plastic Tray
 Covers Honda Cars
 Black Nylon
 Contains 12 Different Sizes
 121 Total Pcs.
 Retainer Assortment
 Sold Each



8177R (Refill Kit)
 Shipped In a 8" x 10" plastic bag
 Sold Each



# 8178 Air Cleaner Hold Down Wing Nut Assortment					
10245	10243	10244	10242	10240	10241
1/4"-20 Thread Size Black Nylon Air Cleaner Hold Down Wing Nuts	1/4"-20 Thread Size Natural Nylon Air Cleaner Hold Down Wing Nuts	1/4"-20 Thread Size Zinc Finish Air Cleaner Hold Down Wing Nuts	1/4-20 x 1" Thread Size Zinc Finish Air Cleaner Hold Down Wing Nuts	1/4-20 Thread Size Yellow Zinc Finish Air Cleaner Hold Down Wing Nuts	8-1.25mm Thread Size Zinc Finish Air Cleaner Hold Down Wing Nuts

8178 (Plastic Tray)
 Shipped In a 6 Hole Plastic Tray
 Covers 1/4"-20 & 6-1.00mm Thread Sizes
 Metal & Nylon
 Contains 6 Different Sizes
 60 Total Pcs.
 Air Cleaner Wing Nut Assortment
 Sold Each

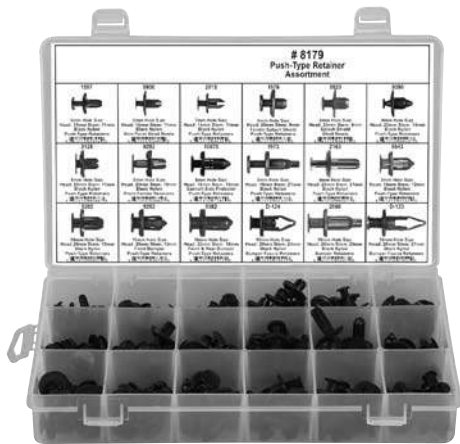

# 8179 Push-Type Retainer Assortment					
1597	9930	2015	1976	9920	9390
6mm Hole Size Head: 15mm Stem: 11mm Black Nylon Push-Type Retainers	6mm Hole Size Head: 18mm Stem: 11mm Black Nylon Vent Panel Blind Rivets	7mm Hole Size Head: 14mm Stem: 11mm Black Nylon Push-Type Retainers	8mm Hole Size Head: 20mm Stem: 9mm Fender Splash Shield Push-Type Retainers	8mm Hole Size Head: 20mm Stem: 9mm Splash Shield Blind Rivets	8mm Hole Size Head: 20mm Stem: 14mm Black Nylon Push-Type Retainers
8mm Hole Size Head: 20mm Stem: 11mm Black Nylon Push-Type Retainers	8mm Hole Size Head: 20mm Stem: 10mm Black Nylon Front Fender Retainers	8mm Hole Size Head: 18mm Stem: 15mm Garnish Side Protector Push-Type Retainers	8mm Hole Size Head: 16mm Stem: 21mm Black Nylon Push-Type Retainers	8mm Hole Size Head: 20mm Stem: 21mm Black Nylon Push-Type Retainers	9mm Hole Size Head: 18mm Stem: 12mm Black Nylon Push-Type Retainers
9mm Hole Size Head: 20mm Stem: 15mm Black Nylon Push-Type Retainers	10mm Hole Size Head: 20mm Stem: 13mm Black Nylon Front Bumper Push-Type Retainers	10mm Hole Size Head: 20mm Stem: 18mm Front & Rear Bumper Push-Type Retainers	D-124 10mm Hole Size Head: 20mm Stem: 24mm Black Nylon Bumper Fascia Retainers	2060 10mm Hole Size Head: 20mm Stem: 25mm Black Nylon Bumper Retainers	D-123 10mm Hole Size Head: 20mm Stem: 27mm Black Nylon Bumper Fascia Retainers

8179 (Plastic Tray)
 Shipped In a 18 Hole Plastic Tray
 Covers 6mm to 10mm Hole Size
 Honda & Acura Cars
 Contains 18 Different Sizes
 164 Total Pcs.
 Push Type Retainer Assortment
 Sold Each

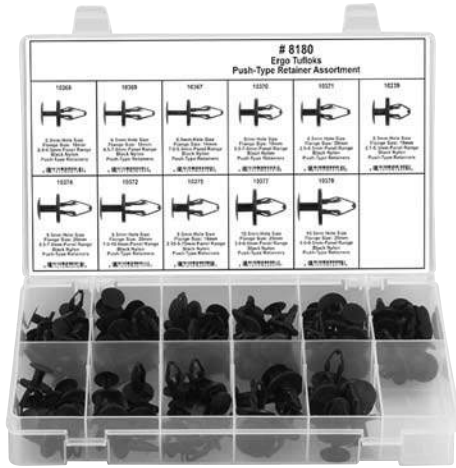

# 8180 Ergo Tufloks Push-Type Retainer Assortment					
 6.5mm Hole Size Flange Size: 18mm 2.0-4.5mm Panel Range Black Nylon Push-Type Retainers	 6.5mm Hole Size Flange Size: 18mm 4.5-7.0mm Panel Range Black Nylon Push-Type Retainers	 6.5mm Hole Size Flange Size: 14mm 7.0-9.5mm Panel Range Black Nylon Push-Type Retainers	 8mm Hole Size Flange Size: 19mm 5.0-7.0mm Panel Range Black Nylon Push-Type Retainers	 8.5mm Hole Size Flange Size: 20mm 2.0-4.5mm Panel Range Black Nylon Push-Type Retainers	 8.5mm Hole Size Flange Size: 19mm 2.7-5.3mm Panel Range Black Nylon Push-Type Retainers
 8.5mm Hole Size Flange Size: 20mm 4.5-7.0mm Panel Range Black Nylon Push-Type Retainers	 8.5mm Hole Size Flange Size: 20mm 7.0-10.0mm Panel Range Black Nylon Push-Type Retainers	 8.5mm Hole Size Flange Size: 18mm 2.95-5.75mm Panel Range Black Nylon Push-Type Retainers	 10.5mm Hole Size Flange Size: 25mm 3.0-6.0mm Panel Range Black Nylon Push-Type Retainers	 10.5mm Hole Size Flange Size: 25mm 6.0-9.0mm Panel Range Black Nylon Push-Type Retainers	

8180 (Plastic Tray)
 Shipped In a 12 Hole Plastic Tray
 6.5mm to 10mm Hole Size
 Black Nylon
 Contains 11 Different Sizes
 110 Total Pcs.
 Ergo Tufloks Retainer Assortment
 Sold Each



# 8181 Low Profile Mini Blade Fuse Assortment					
 # 10829 5 Amp Tan Blade Type Low Profile Type ATM Mini Fuses	 # 10831 10 Amp Red Blade Type Low Profile Type ATM Mini Fuses	 # 10832 15 Amp Blue Blade Type Low Profile Type ATM Mini Fuses	 # 10833 20 Amp Yellow Blade Type Low Profile Type ATM Mini Fuses	 # 10834 25 Amp Natural Blade Type Low Profile Type ATM Mini Fuses	 # 10835 30 Amp Green Blade Type Low Profile Type ATM Mini Fuses

8181 (Plastic Tray)
 Shipped In a 6 Hole Plastic Tray
 5 AMP - 30 AMP ATM Fuses
 Low Profile Type
 Contains 7 Different Sizes
 95 Total Pcs.
 Low Profile Fuse Assortment
 Sold Each

NEW!

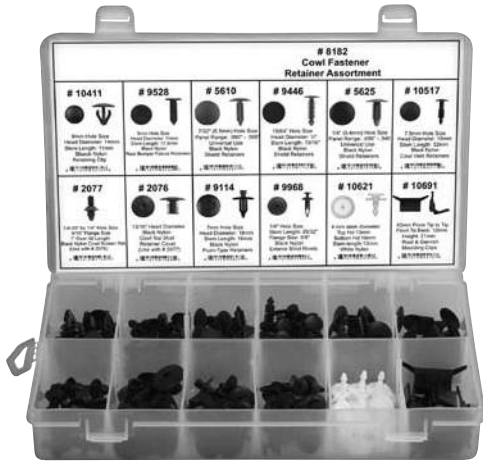

# 8182 Cowl Fastener Retainer Assortment					
# 10411 6mm Hole Size Head Diameter: 14mm Stem Length: 11mm Black Nylon Retaining Clip	# 9528 6mm Hole Size Head Diameter: 11mm Stem Length: 17.8mm Black Nylon Rear Bumper Fascia Retainers	# 5610 7/32" (5.5mm) Hole Size Panel Range: .060" - .555" Universal Use Black Nylon Shield Retainers	# 9446 15/64" Hole Size Head Diameter: 7/8" Stem Length: 15/16" Black Nylon Shield Retainers	# 5625 1/4" (6.4mm) Hole Size Panel Range: .095" - .540" Universal Use Black Nylon Shield Retainers	# 10517 7.5mm Hole Size Head Diameter: 18mm Stem Length: 32mm Black Nylon Cowl Vent Retainers
# 2077 1/4-20" by 1/4" Hole Size 5/16" Flange Size 1" Over All Length Black Nylon Cowl Screen Ret. (Use with # 2076)	# 2076 13/16" Head Diameter Black Nylon Cowl Top Stud Retainer Cover (Use with # 2077)	# 9114 7mm Hole Size Head Diameter: 18mm Stem Length: 18mm Black Nylon Push-Type Retainers	# 9968 1/4" Hole Size Stem Length: 29/32" Flange Size: 5/8" Black Nylon Exterior Blind Rivets	# 10621 4mm stem diameter Top Hd: 13mm Bottom Hd: 15mm Stem length: 13mm White Nylon	# 10691 42mm From Tip to Tip Front To Back: 12mm Height: 21mm Roof & Garnish Moulding Clips

8182 (Plastic Tray)
 Shipped In a 12 Hole Plastic Tray
 Cowl Retainers
 All Nylon
 Contains 12 Different Sizes
 168 Total Pcs.
 Cowl Retainer Assortment
 Sold Each

NEW!



# 8183 Double End & Spot Weld Drill Bit Assortment					
# 10843 1/8" (.125) Drill Size 135° Split Point High Speed Steel Double End Drill Bits	# 10844 3/16" (.1875) Drill Size 135° Split Point High Speed Steel Double End Drill Bits	# 10845 1/4" (.250) Drill Size 135° Split Point High Speed Steel Double End Drill Bits	# 10880 6mm Drill Size For 1/4" Spot Welds Cobalt Spur Point Gold Finish High Speed Steel Spot Weld Drill Bits	# 10881 8mm Drill Size For 5/16" Spot Welds Cobalt Spur Point Gold Finish High Speed Steel Spot Weld Drill Bits	# 10882 10mm Drill Size For 3/8" Spot Welds Cobalt Spur Point Gold Finish High Speed Steel Spot Weld Drill Bits

8183 (Plastic Tray)
 Shipped In a 6 Hole Plastic Tray
 Covers 1/8, 3/16 & 1/4 Double End Bits &
 6mm, 8mm & 10mm Spot Weld Bits
 Contains 6 Different Sizes
 29 Total Pcs.
 Drill Bit Assortment
 Sold Each

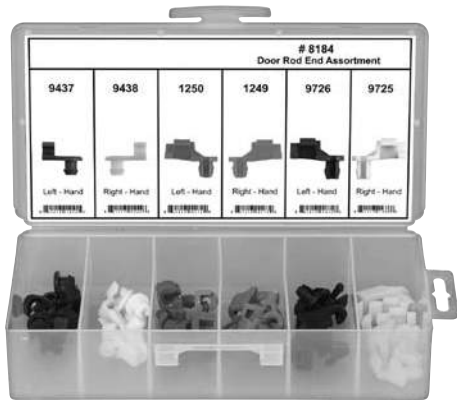

# 8184 Door Rod End Assortment					
9437	9438	1250	1249	9726	9725
Left - Hand	Right - Hand	Left - Hand	Right - Hand	Left - Hand	Right - Hand

8184 (Plastic Tray)
 Shipped In a 6 Hole Plastic Tray
 Covers G.M., Ford, Chrysler
 All Nylon
 Contains 6 Different Sizes
 33 Total Pcs.
 Universal Rod End Assortment
 Sold Each



























# 8185 Zinc Finish Cotter Pin Assortment					
4063	4070	4088	4090	4096	4105
1/16 x 1" Zinc Finish Hammerlock Type Cotter Pins	3/32 x 1" Zinc Finish Hammerlock Type Cotter Pins	1/8 x 1 1/2" Zinc Finish Hammerlock Type Cotter Pins	1/8 x 2" Zinc Finish Hammerlock Type Cotter Pins	5/32 x 1 1/2" Zinc Finish Hammerlock Type Cotter Pins	3/16 x 1 1/2" Zinc Finish Hammerlock Type Cotter Pins

8185 (Plastic Tray)
 Shipped In a 6 Hole Plastic Tray
 Hammerlock Type
 Bright Zinc Finish
 Contains 6 Different Sizes
 150 Total Pcs.
 Cotter Pin Assortment
 Sold Each



BACK OF TRAY

8601					
Universal Nylon Shield Retainer Assortment					
JL-24 1  7/64" (2.5mm) Hole Size Black Universal Nylon Shield Retainers	5602 2  5/32" (4mm) Hole Size Black Universal Nylon Shield Retainers	5605 3  3/16" (4.5mm) Hole Size Black Universal Nylon Shield Retainers	JL-32 4  3/16" (4.5mm) Hole Size Black Universal Weatherstrip Retainers	8172 5  3/16" (4.5mm) Hole Size Black Universal Dash Panel Retainers	5628 6  1/4" (6.4mm) Hole Size Black Universal Nylon Shield Retainers
JL-23 7  13/64" (5.2mm) Hole Size Short Black Weatherstrip Retainers	5609 8  13/64" (5.2mm) Hole Size Long Black Weatherstrip Retainers	JL-26 9  13/64" (5.2mm) Hole Size Long Black Universal Nylon Shield Retainers	5610 10  7/32" (5.5mm) Hole Size Short Black Universal Nylon Shield Retainers	5614 11  7/32" (5.5mm) Hole Size Black Universal Nylon Shield Retainers	5995 12  9/16" (7.8mm) Hole Size Black Rear Hood Seal Retainers
5618 13  15/64" (6mm) Hole Size Black Universal Nylon Shield Retainers	5506 14  1/4" (6.4mm) Hole Size Black Bumper Filler Retainers	5429 15  1/4" (6.4mm) Hole Size Short Black Universal Nylon Shield Retainers	5625 16  1/4" (6.4mm) Hole Size Long Black Universal Nylon Shield Retainers	5632 17  1/4" (6.4mm) Hole Size Black Fascia Panel Retainers	JL-120 8  9/32" (7.1mm) Hole Size Black Textured Hood Panel Retainers
8862B 19  5/16" (7.8mm) Hole Size Black Universal Nylon Shield Retainers	5640 20  9/64" (7.8mm) Hole Size Black Universal Nylon Shield Retainers	JL-33 21  5/16" (7.8mm) Hole Size Black Trim Panel Retainers	5643 22  23/64" (8mm) Hole Size Black Trim Panel Retainers	5710 23  3/8" (9.5mm) Hole Size Black Radiator Panel Retainers	5648 24  25/64" (10mm) Hole Size Black Fascia Bumper Retainers

FRONT OF TRAY

8500 (Bag)

Shipped In a 8" x 10" Plastic Bag

8501 (Metal Tray)

Shipped In a 24 Hole Gray Metal Tray

8601 (Plastic Tray)

Shipped In a 24 Hole Gray Plastic Tray

Covers 2.5mm to 10mm Hole Sizes

Black Nylon

Contains 24 Different Sizes 336 Total Pcs.

Shield Retainer Assortment

Sold Each



BACK OF TRAY					
8603					
Body Bolts, Hex Nuts Extruded "U" Nuts Assortment					
FRONT OF TRAY					

8502 (Bag)

Shipped In a 8" x 10" Plastic Bag

8503 (Metal Tray)

Shipped In a 24 Hole Gray Metal Tray

8603 (Plastic Tray)

Shipped In a 24 Hole Gray Plastic Tray

Covers "U" & Hex Nuts & Body Bolts

Contains 22 Different Sizes

203 Total Pcs.

Body Bolt & Nut Assortment

Sold Each

Metropolitan Supply



BACK OF TRAY					
8605					
Universal Trim Screw Assortment					
6185 1 8 x 1 1/2" Phil. Oval Washer Head Chrome Wheel Operating Midg. Torx® Screws	6401 2 8 x 3/4" #8 Head Phil. Oval Head Chrome Sheet Metal Screws	1184 3 8 x 3/4" #8 Head Phil. Oval Head Black Sheet Metal Screws	7004 4 4.2 - 1.41 x 30 mm Oval Head Chrome Stainless Steel Torx® Trim Screws	5554 5 4.2 - 1.41 x 20 mm Hex Head Chrome Washer Black Torx® Screws	2970 6 8 x 3/4" Phil. Flat Top Washer Head Black Black Trim Screws
6010 7 8 x 1 1/2" Phil. Oval Washer Head Black Wheel Operating Midg. Torx® Screws	6402 8 8 x 1" #8 Head Phil. Oval Head Chrome Sheet Metal Screws	1186 9 8 x 1" #8 Head Phil. Oval Head Black Sheet Metal Screws	7005 10 4.2 - 1.41 x 30 mm Oval Head Black Stainless Steel Torx® Trim Screws	5552 11 4.2 - 1.41 x 20 mm Hex Head Loose Washer Black Torx® Screws	9145 12 10 x 3/4" Phil. Flat Top Washer Head Black Trim Screws
6265 13 8 x 3/4" Phil. Oval Washer Head Black Torx® Screws	6403 14 8 x 1 1/4" #8 Head Phil. Oval Head Chrome Sheet Metal Screws	1624 15 8 x 3/4" Phil. Pan Head Black Sheet Metal Screws	7006 16 4.2 - 1.41 x 25 mm Pan Head Chrome Stainless Steel Torx® Trim Screws	5791 17 8 x 1 1/2" Phil. Flat Top Washer Head Black Trim Screws	18
1077 19 8 x 1 1/2" Indented Torx Washer Head Zinc Torx® Screws	6411 20 10 x 1" #8 Head Phil. Oval Head Chrome Sheet Metal Screws	1625 21 8 x 1" Phil. Pan Head Black Sheet Metal Screws	7007 22 4.2 - 1.41 x 25 mm Pan Head Black Stainless Steel Torx® Trim Screws	5984 23 8 x 3/4" Phil. Flat Top Washer Head Black Trim Screws	1620 24 14 x 3/4" Ind. Hex Washer Head Studded Zinc License Plate Screws
FRONT OF TRAY					

8504 (Bag)

Shipped In a 8" x 10" Plastic Bag

8505 (Metal Tray)

Shipped In a 24 Hole Gray Metal Tray

8605 (Plastic Tray)

Shipped In a 24 Hole Gray Plastic Tray

Covers Phillips, Hex & Torx Drive

Chrome & Black Finishes

Contains 23 Different Sizes

550 Total Pcs.

Trim Screw Assortment



















Sold Each



BACK OF TRAY

8607

Universal Rivet Assortment

1889	1	1901	2	1904	3	4005	4	1609	5	1951	6
											
1/8" Hole Size Grip Range: 2-16" - 1/4" Grip Range: 3/16" - 1/4" All Alum. Pop Rivets		3/16" Hole Size Flange Size 3/8" Grip Range: 1/4" - 3/8" All Alum. Pop Rivets		3/16" Hole Size Flange Size 5/8" Grip Range: 1/4" - 3/8" All Alum. Pop Rivets		3/16" Hole Size Flange Size 9/16" Grip Range: 3/8" - 1/2" All Alum. Black Grip & Face Rivets		3/16" Hole Size Flange Size 7/16" Grip Range: 5/8" - 1 1/4" Black Alum. Withous Midp. & Split-Type Rivets		1/4" Hole Size Flange Size 1 1/8" Grip Range: 3/16" - 1/8" Black Alum. Bumper Cover & Split-Type Rivets	
9116	7	4002	9	4009	10	4007	11	4008	12		
											
1/4" Hole Size Flange Size 3/8" Grip Range: 1/16" - 1/4" Alum. Rivet Steel Mandrel Black Pop Rivets		1/4" Hole Size Flange Size 3/4" Grip Range: 1/2" - 1 1/4" All Steel Black Bumper Rivets		1/4" Hole Size Flange Size 1/2" Grip Range: 3/32" - 1/2" Alum. Rivet Steel Mandrel Blk. Door Handle Rivets		1/4" Hole Size Flange Size 1/2" Grip Range: 1/32" - 3/8" Alum. Rivet Steel Mandrel Window Reg. Peel Rivets		1/4" Hole Size Flange Size 1/2" Grip Range: 3/16" - 1/32" Alum. Rivet Steel Mandrel Glass Step Peel Rivets			
5769	14	9053	15	1195	16		17		18		
											
3/16" (8mm) Hole Size Flange Size 1/32" GR. 1/8" - 1/4" Black Nylon Blind Rivets		1/8" (5mm) Hole Size Flange Size 1/32" GR. 1/16" - 1/4" Black Nylon Blind Rivets		3/16" (5mm) Hole Size Flange Size 1/32" GR. 1/8" - 2/5" Black Nylon Blind Rivets							
9054	19	1390	20	5775	21	5770	22	9128	23		24
											
1/4" (6.3mm) Hole Size Flange Size 1/2" GR. 3/32" - 3/16" Black Nylon Blind Rivets		1/4" (6.3mm) Hole Size Flange Size 1/2" GR. 5/32" - 1/32" Black Nylon Blind Rivets		1/8" (6.3mm) Hole Size Flange Size 4/32" GR. 3/32" - 3/16" Black Nylon Blind Rivets		1/4" (6.3mm) Hole Size Flange Size 4/32" GR. 9/32" - 1/32" Black Nylon Blind Rivets		1/4" (6.3mm) Hole Size Flange Size 2/8" GR. 9/16" - 1/32" Black Nylon Blind Rivets			

FRONT OF TRAY

8506 (Bag)

Shipped In a 8" x 10" Plastic Bag

8507 (Metal Tray)

Shipped In a 24 Hole Gray Metal Tray

8607 (Plastic Tray)

Shipped In a 24 Hole Gray Plastic Tray

Covers 1/8", 3/16" & 1/4" Hole Size

Nylon & Metal Rivets

Contains 19 Different Sizes























263 Total Pcs.

Automotive Rivet Assortment

Sold Each



BACK OF TRAY

8609					
Universal Nylon Shield Retainer Assortment					
 <p>5602 1 5/32" (4mm) Hole Size Black Universal Nylon Shield Retainers</p>	 <p>5605 2 3/16" (4.5mm) Hole Size Black Universal Nylon Shield Retainers</p>	 <p>JL-32 3 3/16" (4.5mm) Hole Size Black Universal Weatherstrip Retainers</p>	 <p>8172 4 3/16" (4.5mm) Hole Size Black Universal Dash Panel Retainers</p>	 <p>1583 5 3/16" (5mm) Hole Size Black Universal Nylon Shield Retainers</p>	 <p>5627 6 3/8" Universal Nylon Trim Panel Retainers</p>
 <p>JL-23 7 13/64" (5.3mm) Hole Size Short Black Weatherstrip Retainers</p>	 <p>5609 8 13/64" (5.3mm) Hole Size Long Black Weatherstrip Retainers</p>	 <p>5614 9 7/32" (5.5mm) Hole Size Black Universal Nylon Shield Retainers</p>	 <p>5506 10 1/4" (6.4mm) Hole Size Black Bumper Filler Retainers</p>	 <p>5429 11 1/8" (3.2mm) Hole Size Short Black Universal Nylon Shield Retainers</p>	 <p>5995 12 9/16" (7.8mm) Hole Size Black Rear Hood Seal Retainers</p>
 <p>5625 13 1/4" (6.4mm) Hole Size Long Black Universal Nylon Shield Retainers</p>	 <p>9130 14 1/4" (6.4mm) Hole Size Extra Long Black Universal Nylon Shield Retainers</p>	 <p>5632 15 1/4" (6.4mm) Hole Size Black Fascia Panel Retainers</p>	 <p>5628 16 1/4" (6.4mm) Hole Size Black Universal Nylon Shield Retainers</p>	 <p>9132 17 9/32" (7.1mm) Hole Size Black Universal Nylon Shield Retainers</p>	 <p>JL-120 18 9/32" (7.1mm) Hole Size Black Textured Head Panel Retainers</p>
 <p>5640 19 5/64" (7.8mm) Hole Size Black Universal Nylon Shield Retainers</p>	 <p>JL-33 21 5/16" (7.8mm) Hole Size Black Trim Panel Retainers</p>	 <p>5643 22 23/64" (3.6mm) Hole Size Black Trim Panel Retainers</p>	 <p>5710 23 3/4" (19.0mm) Hole Size Black Radiator Panel Retainers</p>	 <p>5648 24 25/64" (10mm) Hole Size Black Fascia Bumper Retainers</p>	

FRONT OF TRAY

8508 (Bag)

Shipped In a 8" x 10" Plastic Bag

8509 (Metal Tray)

Shipped In a 24 Hole Gray Metal Tray

8609 (Plastic Tray)

Shipped In a 24 Hole Gray Plastic Tray

Covers 5/32" to 25/64" Hole Sizes

Black Nylon

Contains 23 different sizes

311 Total Pcs.

Shield Retainer Assortment

Sold Each

Metropolitan Supply



BACK OF TRAY

8611

Universal Nut and Shim Assortment

FRONT OF TRAY

8510 (Bag)

Shipped In a 8" x 10" Plastic Bag

8511 (Metal Tray)

Shipped In a 24 Hole Gray Metal Tray

8611 (Plastic Tray)

Shipped In a 24 Hole Gray Plastic Tray

Covers Grille & Push On Nuts & BodyShims

Contains 20 Different Sizes

450 Total Pcs.

Nut & Body Shim Assortment

Sold Each



BACK OF TRAY

8613 Universal Push Type Retainer Assortment					
5675	5935	5676	1861	1860	5677
1/4" (6.35mm) Hole Size Panel Range: 1/4" - 5/16" Black Nylon Push Type Retainer	1/2" (12.7mm) Hole Size Panel Range: 7/16" - 1/2" Black Nylon Push Type Retainer	5/16" (7.94mm) Hole Size Black Nylon Radial/Woodruff Drive Retainer	5/16" (7.94mm) Hole Size Flange 20mm Stem Length: 20mm Push Type Retainer	5/16" (7.94mm) Hole Size Flange 20mm Stem Length: 22mm Push Type Retainer	3/8" (9.52mm) Hole Size Panel Range: 1/4" - 5/16" Black Nylon Push Type Retainer
5940	2128	9282	9294	9382	5672
5/16" (7.94mm) Hole Size Panel Range: 1/4" - 5/16" Black Nylon Push Type Retainer	5/16" (7.94mm) Hole Size Flange: 20mm Stem Length: 11mm Push Type Retainer	3/8" (9.52mm) Hole Size Flange: 20mm Stem Length: 12mm Push Type Retainer	25/64" (9.84mm) Hole Size Flange: 16mm Stem Length: 15mm Push Type Retainer	3/8" (9.52mm) Hole Size Flange: 20mm Stem Length: 15mm Push Type Retainer	1/2" (12.7mm) Hole Size Panel Range: 1/4" - 5/16" Black Nylon Diameter Push Type Retainer
5930	9067	1603	5920	1976	D-123
1/4" (6.35mm) Hole Size Flange: 16mm Stem Length: 15mm Push Type Retainer	1/4" (6.35mm) Hole Size Flange: 17mm Stem Length: 22mm Radial/Woodruff Drive Retainer	3/32" (2.38mm) Hole Size Flange: 15mm Stem Length: 12mm Push Type Retainer	5/16" (7.94mm) Hole Size Flange: 20mm Stem Length: 15mm Spigot Drive Retainer	5/16" (7.94mm) Hole Size Flange: 20mm Stem Length: 15mm Spigot Drive Retainer	3/8" Hole Size Flange: 20mm Stem Length: 27mm Diameter Push Type Retainer
5901	1973	5895	9202		D-124
5/16" (7.94mm) Hole Size Flange: 20mm Stem Length: 15mm Push Type Retainer	5/16" (7.94mm) Hole Size Flange: 15mm Stem Length: 22mm Push Type Retainer	25/64" (9.84mm) Hole Size Flange: 15mm Stem Length: 15mm Spigot Drive Retainer	25/64" (9.84mm) Hole Size Flange: 20mm Stem Length: 15mm Push Type Retainer		3/8" Hole Size Flange: 20mm Stem Length: 24mm Diameter Push Type Retainer

FRONT OF TRAY

- # 8512 (Bag)
Shipped In a 8" x 10" Plastic Bag
- # 8513 (Metal Tray)
Shipped In a 24 Hole Gray Metal Tray
- # 8613 (Plastic Tray)
Shipped In a 24 Hole Gray Plastic Tray

Covers 6mm to 10mm Hole Size
Black Nylon
Contains 23 Different Sizes
204 Total Pcs.
Retainer Assortment
Sold Each

Metropolitan Supply



BACK OF TRAY

8615 Universal Weatherstrip Retainer Hood Insulation and Door Panel Clip Assortment					
<p>9242 1 White Nylon Door Trim Panel Clips</p>	<p>5264 2 Natural Nylon Door Trim Panel Clips</p>	<p>1646 3 Natural Nylon Door Trim Panel Clips</p>	<p>4020 4 Natural Nylon Door Trim Panel Clips</p>	<p>2029 5 White Nylon Push-Type Door Trim Panel Clips</p>	<p>1930 6 1/4" (6.4mm) Hole Size 1 21/32" O.D. Head Size Black Nylon Hood Insulation Clips</p>
<p>1575 7 Black Nylon Door Trim Panel Clips</p>	<p>1742 8 Natural Nylon Door Trim Panel Clips</p>	<p>2108 9 White Nylon Door Trim Panel Clips</p>			<p>5440 12 1/4" (6.4mm) Hole Size 2" O.D. Head Size Black Polypropylene Hood Insulation Clips</p>
<p>2063 13 4.7mm Hole Size Top Head Dia: 13mm Stem Length: 15mm White Nylon Door Panel Retainers</p>	<p>9444 14 8mm Hole Size Top Head Dia: 13mm Stem Length: 15mm White Nylon Door Panel Retainers</p>	<p>9081 15 8mm Hole Size Top Head Dia: 13mm Stem Length: 17mm White Nylon Door Panel Retainers</p>	<p>1996 16 8mm Hole Size Head Dia: 13mm Stem Length: 17mm Black Nylon Retaining Clips</p>	<p>1950 17 7mm Hole Size Head Dia: 30mm Stem Length: 17mm Black Nylon Retaining Clips</p>	<p>5440 18 1/4" (6.4mm) Hole Size 2" O.D. Head Size Black Polypropylene Hood Insulation Clips</p>
<p>1991 19 4.5mm Hole Size Black Nylon Weatherstrip Retainers</p>	<p>9264 20 4.5mm Hole Size Black Nylon Weatherstrip Retainers</p>	<p>9208 21 8mm Hole Size Orange Nylon Weatherstrip Retainers</p>	<p>5606 22 6mm Hole Size Head Dia: 18mm Stem Length: 17mm Black Nylon Hood Insulation Retainers</p>	<p>9262 23 6mm Hole Size Head Dia: 12mm Stem Length: 9mm Black Nylon Hood Insulation Retainers</p>	

FRONT OF TRAY

8514 (Bag)

Shipped In a 8" x 10" Plastic Bag

8515 (Metal Tray)

Shipped In a 24 Hole Gray Metal Tray

8615 (Plastic Tray)

Shipped In a 24 Hole Gray Plastic Tray

Covers G.M., Ford & Chrysler

All Nylon

Contains 21 Different Sizes

197 Total Pcs.

Door Panel, W/Strip & Hood Ins Asst

Sold Each

Metropolitan Supply



BACK OF TRAY

8617

**Standard Hex Nut, Lockwasher
Flatwasher & Hex Head Cap Screw
Assortment**

1313 1  1/4" - 20 (USS) 7/16" Wrench Size Zinc Finish Hex Nuts 	1314 2  5/16" - 18 (USS) 1/2" Wrench Size Zinc Finish Hex Nuts 	1315 3  3/8" - 16 (USS) 9/16" Wrench Size Zinc Finish Hex Nuts 	1316 4  7/16" - 14 (USS) 1 1/16" Wrench Size Zinc Finish Hex Nuts 	1317 5  1/2" - 13 (USS) 3/4" Wrench Size Zinc Finish Hex Nuts 	1353 6  1/2" - 13 x 2" (USS) Grade 5 Zinc Finish Hex Head Cap Screws 
1325 7  1/4" Bright Zinc Finish Standard Lockwashers 	1326 8  5/16" Bright Zinc Finish Standard Lockwashers 	1327 9  3/8" Bright Zinc Finish Standard Lockwashers 	1328 10  7/16" Bright Zinc Finish Standard Lockwashers 	1329 11  1/2" Bright Zinc Finish Standard Lockwashers 	9749 12  7/16" - 14 x 1 1/2" (USS) Grade 5 Zinc Finish Hex Head Cap Screws 
1364 13  1/4" (SAE) Bright Zinc Finish Flatwashers 	1365 14  5/16" (SAE) Bright Zinc Finish Flatwashers 	1366 15  3/8" (SAE) Bright Zinc Finish Flatwashers 	1367 16  7/16" (SAE) Bright Zinc Finish Flatwashers 	1368 17  1/2" (SAE) Bright Zinc Finish Flatwashers 	1345 18  3/8" - 16 x 2" (USS) Grade 5 Zinc Finish Hex Head Cap Screws 
1331 19  1/4" - 20 x 3/4" (USS) Grade 5 Zinc Finish Hex Head Cap Screws 	1332 20  1/4" - 20 x 1" (USS) Grade 5 Zinc Finish Hex Head Cap Screws 	1337 21  5/16" - 18 x 1" (USS) Grade 5 Zinc Finish Hex Head Cap Screws 	1339 22  5/16" - 18 x 1 1/2" (USS) Grade 5 Zinc Finish Hex Head Cap Screws 	1342 23  3/8" - 16 x 1" (USS) Grade 5 Zinc Finish Hex Head Cap Screws 	1344 24  3/8" - 18 x 1 1/2" (USS) Grade 5 Zinc Finish Hex Head Cap Screws 

FRONT OF TRAY

8516 (Bag)

Shipped In a 8" x 10" Plastic Bag

8517 (Metal Tray)

Shipped In a 24 Hole Gray Metal Tray

8617 (Plastic Tray)

Shipped In a 24 Hole Gray Plastic Tray

Covers 1/4 to 1/2" Nuts, Flats, Locks &

Grade 5 Cap Screws

Contains 24 Different Sizes

612 Total Pcs.

Nut, Washer & Hex Cap Screw Assortment















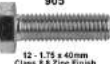







Sold Each



BACK OF TRAY

8619

**Metric Hex Nut, Lockwasher
Flatwasher & Hex Head Cap Screw
Assortment**

<p>862 1</p>  <p>5 - 30mm 8mm Wrench Size Zinc Finish Metric Hex Nuts</p>	<p>863 2</p>  <p>6 - 1.60mm 12mm Wrench Size Zinc Finish Metric Hex Nuts</p>	<p>865 3</p>  <p>8 - 1.25mm 13mm Wrench Size Zinc Finish Metric Hex Nuts</p>	<p>866 4</p>  <p>10 - 1.50mm 17mm Wrench Size Zinc Finish Metric Hex Nuts</p>	<p>867 5</p>  <p>12 - 1.75mm 19mm Wrench Size Zinc Finish Metric Hex Nuts</p>	<p>905 6</p>  <p>12 - 1.75 x 40mm Class 8.8 Zinc Finish Hex Head Cap Screws</p>
<p>1659 7</p>  <p>5mm Bright Zinc Finish Metric Lockwashers</p>	<p>1661 8</p>  <p>6mm Bright Zinc Finish Metric Lockwashers</p>	<p>1662 9</p>  <p>8mm Bright Zinc Finish Metric Lockwashers</p>	<p>1663 10</p>  <p>10mm Bright Zinc Finish Metric Lockwashers</p>	<p>1664 11</p>  <p>12mm Bright Zinc Finish Metric Lockwashers</p>	<p>904 12</p>  <p>12 - 1.75 x 30mm Class 8.8 Zinc Finish Hex Head Cap Screws</p>
<p>1652 13</p>  <p>5mm Bright Zinc Finish Metric Flatwashers</p>	<p>1654 14</p>  <p>6mm Bright Zinc Finish Metric Flatwashers</p>	<p>1655 15</p>  <p>8mm Bright Zinc Finish Metric Flatwashers</p>	<p>1656 16</p>  <p>10mm Bright Zinc Finish Metric Flatwashers</p>	<p>1657 17</p>  <p>12mm Bright Zinc Finish Metric Flatwashers</p>	<p>899 18</p>  <p>10 - 1.50 x 50mm Class 8.8 Zinc Finish Hex Head Cap Screws</p>
<p>874 19</p>  <p>5 - 20 x 25mm Class 8.8 Zinc Finish Hex Head Cap Screws</p>	<p>877 20</p>  <p>6 - 1.80 x 20mm Class 8.8 Zinc Finish Hex Head Cap Screws</p>	<p>880 21</p>  <p>8 - 1.60 x 15mm Class 8.8 Zinc Finish Hex Head Cap Screws</p>	<p>888 22</p>  <p>8 - 1.50 x 30mm Class 8.8 Zinc Finish Hex Head Cap Screws</p>	<p>890 23</p>  <p>8 - 1.25 x 50mm Class 8.8 Zinc Finish Hex Head Cap Screws</p>	<p>895 24</p>  <p>10 - 1.50 x 30mm Class 8.8 Zinc Finish Hex Head Cap Screws</p>

FRONT OF TRAY

8518 (Bag)

Shipped In a 8" x 10" Plastic Bag

8519 (Metal Tray)

Shipped In a 24 Hole Gray Metal Tray

8619 (Plastic Tray)

Shipped In a 24 Hole Gray Plastic Tray

Covers 5mm to 12mm Nuts, Flats, Locks

Hex Cap Screws

Contains 24 Different Sizes

698 Total Pcs.

Metric Cap Screw Assortment

Sold Each



BACK OF TRAY

8620
G.M. Rocker Pannel
Moulding Assortment

Photos Not Actual Size

<p># 10826 1</p> <p>8mm Hole Size Stem Length: 15mm Top Hd Size: 12mm x 20mm Bottom Head Size: 12mm x 20mm Black Nylon Rocker Panel Moulding Clips</p>	<p># 10485 2</p> <p>8mm Hole Size Stem Length: 16mm Top Head Size: 16mm x 20mm Yellow Nylon W/Swedge Rocker Panel Moulding Clips</p>	<p># 10357 3</p> <p>8mm Hole Size Stem Length: 16mm Top Head: 12mm x 20mm White Nylon Rocker Panel Moulding Clips</p>	<p># 10481 4</p> <p>8mm Hole Size Stem Length: 15mm Top Head: 12mm x 20mm Gray Nylon W/Swedge Rocker Panel Moulding Clips</p>	<p># 10480 5</p> <p>8mm Hole Size Stem Length: 11mm Top Head: 12mm x 20mm White Nylon Rocker Panel Moulding Clips</p>	<p># 10551 6</p> <p>17mm Hole Size Top Head: 20mm x 20mm Overall Length: 28mm Black Nylon Rocker Panel Moulding Clips</p>
<p># 10680 7</p> <p>10mm Hole Size Top Hd Size: 10" x 13"1/2" Bottom Hd Size: 10" x 13"1/2" White Nylon Rocker & Grille Moulding Clips</p>	<p># 10827 8</p> <p>10mm Hole Size Stem Length: 15mm Top Hd Size: 12mm x 20mm Bottom Head Size: 12mm x 20mm White Nylon Rocker Panel Moulding Clips</p>	<p># 9992 9</p> <p>7/16" Hole Size Top Head Dia: 9/16" x 13/16" 8/16" Stem Length Black Nylon Front Fender Wheel Covering Mldg. Clips</p>	<p># 9991 10</p> <p>7/16" Hole Size Top Head Dia: 15/32" x 25/32" 8/16" Stem Length Narrow Nylon Rear Wheel Covering Mldg. Clips</p>	<p># 9990 11</p> <p>7/16" Hole Size Top Head Dia: 15/32" x 25/32" 8/16" Stem Length White Nylon Rear Wheel Covering Mldg. Clips</p>	<p># 10059 12</p> <p>7/16" Hole Size Top Width: 2" Length Gray Nylon Rocker Panel Clips</p>
<p># 10056 13</p> <p>7/16" Hole Size Stem Length: 18/32" White Nylon Rocker Panel Moulding Clips</p>	<p># 10429 14</p> <p>7/16" Hole Size Stem Length: 8/16" x 1 5/8" Clay Nylon Rocker Panel Moulding Clips</p>	<p># 9914 15</p> <p>7/16" Hole Size Stem Length: 8/16" Green Nylon Rocker Panel Moulding Clips</p>	<p># 9915 16</p> <p>7/16" Hole Size Stem Length: 8/16" White Nylon Rocker Panel Moulding Clips</p>	<p># 10823 17</p> <p>7mm Hole Size Top Head Size: 12mm x 20mm Bottom Head Size: 12mm x 20mm White Nylon Rocker Panel Moulding Clips</p>	<p># 10058 18</p> <p>7/16" Hole Size Stem Length: 1 1/8" Top Hd Size: 1 1/8" x 1 1/2" Bottom Head Size: 7/16" x 8/16" Gray Nylon Rocker Panel Moulding Clips</p>
<p># 9999 19</p> <p>5/16" Hole Size 11/16" x 1 3/16" Head Size 8/16" Stem Length Black Nylon Rocker Panel Moulding Clips</p>	<p># 10488 20</p> <p>5/16" Hole Size Stem Length: 18mm Top Head: 11/16" x 1 5/16" Black Nylon Rocker Panel Moulding Clips</p>	<p># 10489 21</p> <p>5/16" Hole Size Stem Length: 11/16" Top Head: 11/16" x 1 5/16" Black Nylon Rocker Panel Moulding Clips</p>	<p># 9967 22</p> <p>5/16" Hole Size 13/32" x 5/16" Head Size 5/16" Stem Length Black Nylon Rocker Panel Moulding Clips</p>	<p># 10482 23</p> <p>10mm Hole Size Stem Length: 18mm Head Size: 12mm x 20mm Lower Nylon Body Side Moulding Clips</p>	<p># 10128 24</p> <p>7/16" Hole Size Top Width: 2" Length: 2" Gray Nylon Rocker Moulding Clips</p>

FRONT OF TRAY

8520 (Metal Tray)

Shipped In a 24 Hole Gray Metal Tray

8620 (Plastic Tray)

Shipped In a 24 Hole Gray Plastic Tray

Covers G.M. Cars & Trucks

All Nylon

Contains 24 Different Sizes

220 Total Pcs.

G.M. Rocker Panel Moulding Assortment

Sold Each

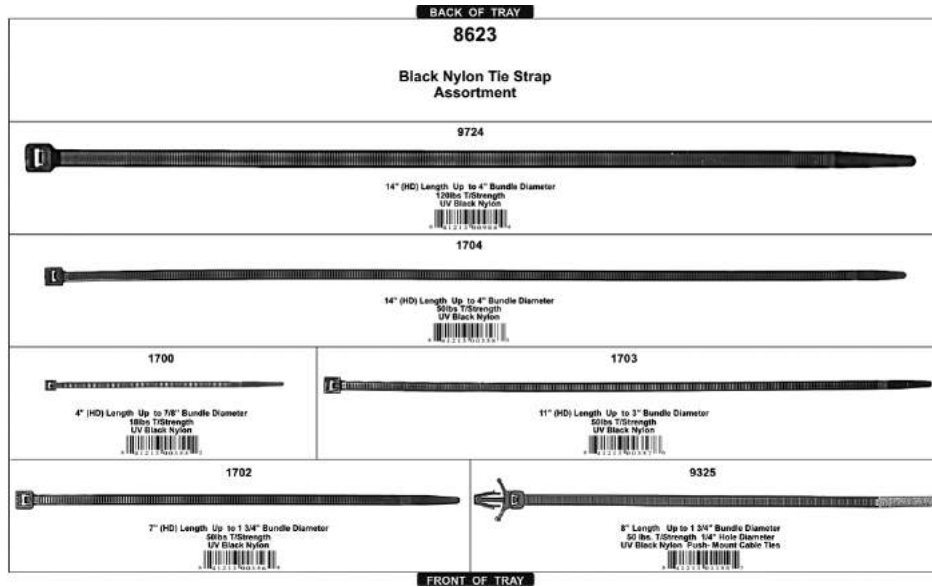

8623 (Plastic Tray)

Shipped In an Adjustable Gray Plastic Tray

Covers 4", 7", 8", 11", 14" and 14" HD
 Black Nylon Ties
 Contains 6 Different Sizes
 310 Total Pcs.
 Black Nylon Tie Strap Assortment
 Sold Each



BACK OF TRAY

8625 Universal Domestic Door Rod & Hood Prop Clips Assortment							
1	9728	2	9981	3	10076	4	10079
5	10080	6	10081	7	10077	8	
9	10078	10	9725	11	9729	12	9726
13	9384	14	9987	15	10082	16	
17	9438	18	1083	19	10083	20	9986
21	10084	22	9437	23	9731	24	
25	9988	26	1250	27	9960	28	9963
29	9961	30	1249	31	9950	32	9962

FRONT OF TRAY

8625 (Plastic Tray)
Shipped In an Adjustable Gray Plastic Tray

























8625YC (Plastic Tray)
Shipped In an Adjustable Yellow Plastic Tray

Covers G.M., Ford, Chrysler
All Nylon
Contains 29 Different Sizes
310 Total Pcs.
Door Rod and Hood Prop Assortment
Sold Each



BACK OF TRAY

8629
Bright Zinc Finish
10.9 J.I.S. Small Head
Metric Hex Flange Bolt
Assortment

<p>3200 1</p>  <p>6 - 1.00mm Class 10 15mm Hex 14mm Serrated Flange Bright Zinc Finish Metric Spin Lock Nuts - JIS B1189</p>	<p>3201 9981</p>  <p>8 - 1.25mm Class 10 12mm Hex 17mm Serrated Flange Bright Zinc Finish Metric Spin Lock Nuts - JIS B1189</p>	<p>3202 3</p>  <p>10 - 1.25mm Class 10 14mm Hex 18mm Serrated Flange Bright Zinc Finish Metric Spin Lock Nuts - JIS B1189</p>	<p>3203 4</p>  <p>6 - 1.00 x 12mm Class 10.9 10mm Hex 14mm Flange Bright Zinc Finish Metric Flange Bolts - JIS B1189</p>	<p>3204 5</p>  <p>6 - 1.00 x 16mm Class 10.9 10mm Hex 14mm Flange Bright Zinc Finish Metric Flange Bolts - JIS B1189</p>	<p>3219 6</p>  <p>10 - 1.25 x 25mm Class 10.9 14mm Hex 21mm Flange Bright Zinc Finish Metric Flange Bolts - JIS B1189</p>
<p>3205 7</p>  <p>6 - 1.00 x 20mm Class 10.9 10mm Hex 14mm Flange Bright Zinc Finish Metric Flange Bolts - JIS B1189</p>	<p>3206 8</p>  <p>6 - 1.00 x 25mm Class 10.9 10mm Hex 14mm Flange Bright Zinc Finish Metric Flange Bolts - JIS B1189</p>	<p>3207 9</p>  <p>6 - 1.00 x 30mm Class 10.9 10mm Hex 14mm Flange Bright Zinc Finish Metric Flange Bolts - JIS B1189</p>	<p>3208 10</p>  <p>6 - 1.00 x 35mm Class 10.9 10mm Hex 14mm Flange Bright Zinc Finish Metric Flange Bolts - JIS B1189</p>	<p>3209 11</p>  <p>6 - 1.00 x 40mm Class 10.9 10mm Hex 14mm Flange Bright Zinc Finish Metric Flange Bolts - JIS B1189</p>	<p>3220 12</p>  <p>10 - 1.25 x 30mm Class 10.9 14mm Hex 21mm Flange Bright Zinc Finish Metric Flange Bolts - JIS B1189</p>
<p>9624 13</p>  <p>6 - 1.00 x 45mm Class 10.9 10mm Hex 14mm Flange Bright Zinc Finish Metric Flange Bolts - JIS B1189</p>	<p>3210 14</p>  <p>8 - 1.25 x 12mm Class 10.9 12mm Hex 17.5mm Flange Bright Zinc Finish Metric Flange Bolts - JIS B1189</p>	<p>3211 15</p>  <p>8 - 1.25 x 16mm Class 10.9 12mm Hex 17.5mm Flange Bright Zinc Finish Metric Flange Bolts - JIS B1189</p>	<p>3212 16</p>  <p>8 - 1.25 x 20mm Class 10.9 12mm Hex 17.5mm Flange Bright Zinc Finish Metric Flange Bolts - JIS B1189</p>	<p>3213 17</p>  <p>8 - 1.25 x 25mm Class 10.9 12mm Hex 17.5mm Flange Bright Zinc Finish Metric Flange Bolts - JIS B1189</p>	<p>3221 18</p>  <p>10 - 1.25 x 35mm Class 10.9 14mm Hex 21mm Flange Bright Zinc Finish Metric Flange Bolts - JIS B1189</p>
<p>3214 19</p>  <p>8 - 1.25 x 30mm Class 10.9 12mm Hex 17.5mm Flange Bright Zinc Finish Metric Flange Bolts - JIS B1189</p>	<p>3215 20</p>  <p>8 - 1.25 x 35mm Class 10.9 12mm Hex 17.5mm Flange Bright Zinc Finish Metric Flange Bolts - JIS B1189</p>	<p>3216 21</p>  <p>8 - 1.25 x 40mm Class 10.9 12mm Hex 17.5mm Flange Bright Zinc Finish Metric Flange Bolts - JIS B1189</p>	<p>3217 22</p>  <p>10 - 1.25 x 16mm Class 10.9 14mm Hex 21mm Flange Bright Zinc Finish Metric Flange Bolts - JIS B1189</p>	<p>3218 23</p>  <p>10 - 1.25 x 20mm Class 10.9 14mm Hex 21mm Flange Bright Zinc Finish Metric Flange Bolts - JIS B1189</p>	<p>3222 24</p>  <p>10 - 1.25 x 40mm Class 10.9 14mm Hex 21mm Flange Bright Zinc Finish Metric Flange Bolts - JIS B1189</p>

FRONT OF TRAY

8629 (Plastic Tray)

Shipped In a 24 Hole Gray Plastic Tray

Covers 6mm, 8mm, & 10mm Screw Sizes
 Class 10.9 Hex Flange Nuts & Bolts
 Contains 24 Different Sizes
 229 Total Pcs.
 Metric Hex Flange Bolt Assortment
 Sold Each



BACK OF TRAY

8631

**Bright Zinc Finish
Hammerlock Type
Cotter Pin Assortment**

4062  1/16 x 3/4" Bright Zinc Finish Hammerlock Type Cotter Pins	4063  1/16 x 1" Bright Zinc Finish Hammerlock Type Cotter Pins	4065  1/16 x 1 1/2" Bright Zinc Finish Hammerlock Type Cotter Pins	4069  3/32 x 3/4" Bright Zinc Finish Hammerlock Type Cotter Pins	4070  3/32 x 1" Bright Zinc Finish Hammerlock Type Cotter Pins	4108  3/16 x 2 1/2" Bright Zinc Finish Hammerlock Type Cotter Pins
4072  3/32 x 1 1/2" Bright Zinc Finish Hammerlock Type Cotter Pins	4074  3/32 x 2" Bright Zinc Finish Hammerlock Type Cotter Pins	4084  5/8 x 3/4" Bright Zinc Finish Hammerlock Type Cotter Pins	4086  5/8 x 1" Bright Zinc Finish Hammerlock Type Cotter Pins	4087  5/8 x 1 1/4" Bright Zinc Finish Hammerlock Type Cotter Pins	4112  5/8 x 1" Bright Zinc Finish Hammerlock Type Cotter Pins
4088  5/8 x 1 1/2" Bright Zinc Finish Hammerlock Type Cotter Pins	4089  5/8 x 1 3/4" Bright Zinc Finish Hammerlock Type Cotter Pins	4090  5/8 x 2" Bright Zinc Finish Hammerlock Type Cotter Pins	4091  1/2 x 1 1/2" Bright Zinc Finish Hammerlock Type Cotter Pins	4094  5/32 x 1" Bright Zinc Finish Hammerlock Type Cotter Pins	4114  1/4 x 1 1/2" Bright Zinc Finish Hammerlock Type Cotter Pins
4096  5/32 x 1 1/2" Bright Zinc Finish Hammerlock Type Cotter Pins	4098  5/32 x 2" Bright Zinc Finish Hammerlock Type Cotter Pins	4103  3/16 x 1" Bright Zinc Finish Hammerlock Type Cotter Pins	4105  3/16 x 1 1/2" Bright Zinc Finish Hammerlock Type Cotter Pins	4107  3/16 x 4" Bright Zinc Finish Hammerlock Type Cotter Pins	4116  1/4 x 2" Bright Zinc Finish Hammerlock Type Cotter Pins

FRONT OF TRAY









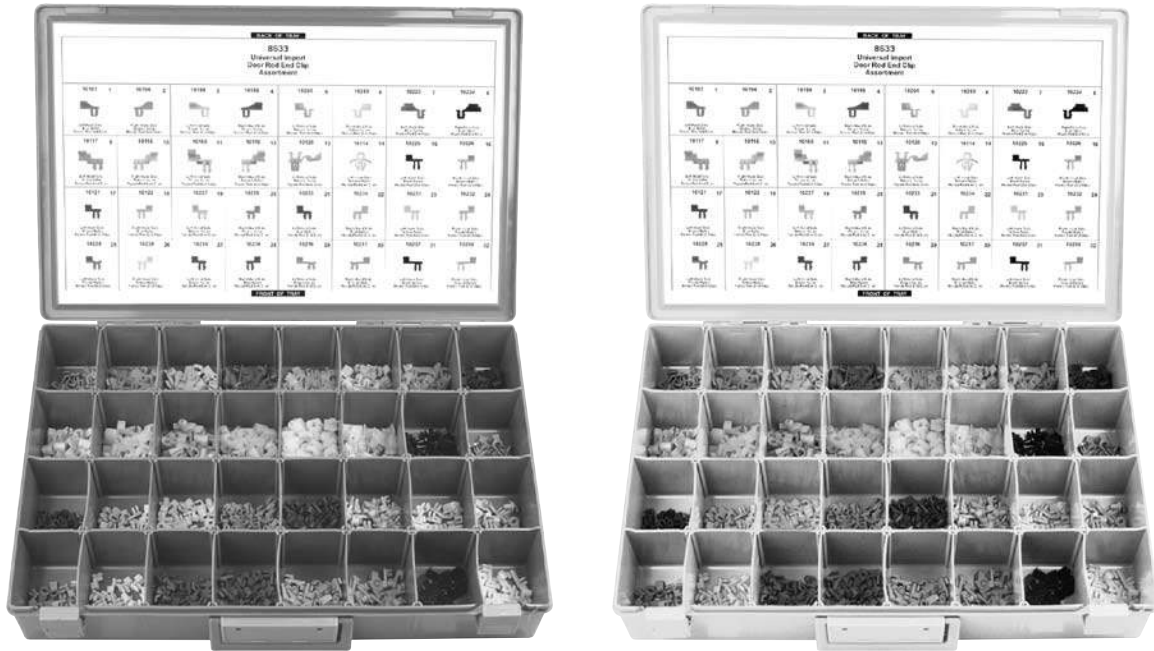























8531 (Metal Tray)
Shipped In a 24 Hole Gray Metal Tray

8631 (Plastic Tray)
Shipped In a 24 Hole Gray Plastic Tray

Hammerlock Type
Bright Zinc Finish
Contains 24 Different Sizes
825 Total Pcs.
Cotter Pin Assortment
Sold Each

Metropolitan Supply



BACK OF TRAY							
8633 Universal Import Door Rod End Clip Assortment							
10197 1  Left Hand Side Black Nylon Nissan Rod End Clip	10196 2  Right Hand Side Chrome Nylon Nissan Rod End Clip	10199 3  Left Hand Side Chrome Nylon Nissan Rod End Clip	10198 4  Right Hand Side Plastic Nylon Nissan Rod End Clip	10201 5  Left Hand Side Yellow Nylon Nissan Rod End Clip	10200 6  Right Hand Side Yellow Nylon Nissan Rod End Clip	10223 7  Left Hand Side Black Nylon Mazda Rod End Clip	10224 8  Right Hand Side Black Nylon Mazda Rod End Clip
10117 9  Left Hand Side Black Nylon Toyota Rod End Clip	10116 10  Right Hand Side Chrome Nylon Toyota Rod End Clip	10109 11  Left Hand Side Chrome Nylon Toyota Rod End Clip	10110 12  Right Hand Side Plastic Nylon Toyota Rod End Clip	10120 13  Left Hand Side Yellow Nylon Toyota Rod End Clip	10114 14  Left Hand Side Black Nylon Honda Rod End Clip	10225 15  Left Hand Side Black Nylon Honda Rod End Clip	10226 16  Right Hand Side Black Nylon Honda Rod End Clip
10121 17  Left Hand Side Black Nylon Honda Rod End Clip	10122 18  Right Hand Side Chrome Nylon Honda Rod End Clip	10227 19  Left Hand Side Chrome Nylon Honda Rod End Clip	10228 20  Right Hand Side Plastic Nylon Honda Rod End Clip	10233 21  Left Hand Side Yellow Nylon Honda Rod End Clip	10234 22  Right Hand Side Yellow Nylon Honda Rod End Clip	10231 23  Left Hand Side Black Nylon Honda Rod End Clip	10232 24  Right Hand Side Black Nylon Honda Rod End Clip
10229 25  Left Hand Side Black Nylon Honda Rod End Clip	10230 26  Right Hand Side Chrome Nylon Honda Rod End Clip	10235 27  Left Hand Side Chrome Nylon Honda Rod End Clip	10236 28  Right Hand Side Plastic Nylon Honda Rod End Clip	10216 29  Left Hand Side Yellow Nylon Honda Rod End Clip	10217 30  Right Hand Side Yellow Nylon Honda Rod End Clip	10237 31  Left Hand Side Black Nylon Honda Rod End Clip	10238 32  Right Hand Side Black Nylon Honda Rod End Clip
FRONT OF TRAY							

8633 (Plastic Tray)

Shipped In a 32 Hole Adjustable Gray Plastic Tray

8633YC (Plastic Tray)

Shipped In a 32 Hole Adjustable Yellow Plastic Tray

Covers Honda, Toyota, Nissan, Mazda

Cars & Trucks

Contains 32 Different Sizes

860 Total Pcs.

Door Rod End Clip Assortment

Sold Each



BACK OF TRAY

8633X
Universal Import
Door Rod End Clip
Assortment

10197 1 Left Hand Side Blue Nylon Nissan Rod End Clips	10196 2 Right Hand Side Orange Nylon Nissan Rod End Clips	10199 3 Left Hand Side Citrus Nylon Nissan Rod End Clips	10198 4 Right Hand Side Purple Nylon Nissan Rod End Clips	10201 5 Left Hand Side Natural Nylon Nissan Rod End Clips	10200 6 Right Hand Side Yellow Nylon Nissan Rod End Clips	10223 7 Left Hand Side Black Nylon Mazda Rod End Clips	10224 8 Right Hand Side Black Nylon Mazda Rod End Clips
10117 9 Left Hand Side Yellow Nylon Toyota Rod End Clips	10116 10 Right Hand Side Natural Nylon Toyota Rod End Clips	10109 11 Left Hand Side Yellow Nylon Toyota Rod End Clips	10110 12 Right Hand Side Natural Nylon Toyota Rod End Clips	10120 13 Left Hand Side Natural Nylon Toyota Rod End Clips	10114 14 Left Hand Side Natural Nylon Honda Rod End Clips	10225 15 Left Hand Side Black Nylon Honda Rod End Clips	10226 16 Right Hand Side Brown Nylon Honda Rod End Clips
10121 17 Left Hand Side Brown Nylon Honda Rod End Clips	10122 18 Right Hand Side Black Nylon Honda Rod End Clips	10227 19 Left Hand Side Natural Nylon Honda Rod End Clips	10228 20 Right Hand Side Purple Nylon Honda Rod End Clips	10233 21 Left Hand Side Blue Nylon Honda Rod End Clips	10234 22 Right Hand Side Pink Nylon Honda Rod End Clips	10231 23 Left Hand Side Yellow Nylon Honda Rod End Clips	10232 24 Right Hand Side Purple Nylon Honda Rod End Clips
10229 25 Left Hand Side Purple Nylon Honda Rod End Clips	10230 26 Right Hand Side Yellow Nylon Honda Rod End Clips	10235 27 Left Hand Side Brown Nylon Honda Rod End Clips	10236 28 Right Hand Side Blue Nylon Honda Rod End Clips	10216 29 Left Hand Side Purple Nylon Honda Rod End Clips	10217 30 Right Hand Side Orange Nylon Honda Rod End Clips	10237 31 Left Hand Side Black Nylon Honda Rod End Clips	10238 32 Right Hand Side Natural Nylon Honda Rod End Clips

FRONT OF TRAY

8633X (Plastic Tray)

Shipped In a 32 Hole Adjustable Gray Plastic Tray

Covers Honda, Toyota, Nissan, Mazda
Cars and Trucks
Contains 32 Different Sizes
425 Total Pcs.
Door Rod End Clip Assortment
Sold Each

Metropolitan Supply



BACK OF TRAY

8635 Wire Harness Pigtail Assortment							
9773 1  (2) 18ga (12) Leads White (12) Pin Male 4 Pin Vehicle Plug	9779 2  (1) 17 Gauge Yellow, Green, Black (2) Pin Female Light Socket Pigtail I	9780 3  (2) 17 Leads Brown, Black One Housing Light Socket Pigtail II	1396 4  (3) 19 Leads 18ga Black (2) Pin Housing Headlamps Pigtail	9775 5  (2) 9 Leads Brown, Black (2) Pin Headlamp Marker & License Socket Pigtail	9909 6  (2) 18ga (7) Leads Green, Red (2) Pin Headlamp Brake Light Switch Pigtail	9908 7  (2) 18ga (7) Leads Orange, Yellow (2) Pin Headlamp Alternator Warning Pigtail	9907 8  (2) 18ga (7) Leads Black, Blue (2) Pin Headlamp Alternator Warning Pigtail
9776 9  (1) 16 Leads (1) Red (2) Blue Green, White, Blue (4) Pin Vehicle Voltage Regulator Pigtail	9778 10  (2) 16 Leads (1) 18ga (1) 14ga (2) 20ga Yellow-Green, Orange, Black (2) Pin Headlamp Housing & A/C Fan Speed Pigtail	9813 11  Fuses Head No. 15, 16, 18ga (2) 20ga Lead (2) Pin Headlamp Governor Motor Resistor Pigtail	9800 12  (4) 8 Leads 18ga Yellow, Green Orange, Black (2) Pin AC Delco 190 Terminal Pigtail	9774 13  (2) 18ga (7) Leads Brown, Black, Green/Red (2) Pin 4 Pin & 6 Pin Lamp Pigtail	9767 14  (2) 8 (2) 16 Leads White (2) Pin Headlamp Vehicle Speed Sensor Pigtail II	9768 15  (2) 18 (2) 16 Leads (2) 18ga Black-Orange (2) 20ga Yellow (2) Pin Headlamp Alternator Sensor Assembly Pigtail	
9769 16  (2) 16ga Housing AC Clutch Fuses Coil Connector Pigtail	9770 17  (2) 8 Leads 18ga Lead, Red, White, Green, Orange, Black (2) Pin Headlamp Housing & A/C Blower Switches Resistor Pigtail	9771 18  (2) 12 Leads Green & Orange (2) Pin Headlamp Power Brake Connector Pigtail	9799 22  (1) 12 (2) 18ga (7) Leads (2) Pin Headlamp Multi-Function Switch Pigtail	9798 19  (2) 18ga (2) 12ga (5) 16ga (2) 20ga Housing Horn & Speed Warning Light Pigtail	9777 20  (1) 6 Leads 18ga (5) 16ga (2) 20ga Housing Turn Signal & Windshield Wiper Resistor Pigtail	9772 21  (2) 8 Leads (2) 20ga (1) 18ga (1) 16ga (2) 14ga (2) Pin Headlamp Down Mounted Headlamp Switch Resistor Pigtail	9834 23  (2) 18ga (5) 16ga (2) 20ga Housing Multi-Function Switch Pigtail

FRONT OF TRAY

8635 (Plastic Tray) Shipped In an Adjustable Gray Plastic Tray

Covers G.M., Ford & Nissan
Cars & Trucks
Contains 23 Different Sizes
30 Total Pcs.
Wire Harness Assortment
Sold Each



BACK OF TRAY

8637 Ergo Tufloks Push-Type Retainer Assortment		
10368	1	10371
6.5mm Hole Size - 18mm Flange Size 3.2x3.2mm Push Flange Black Nylon Push-Type Retainers		2
10369	4	10239
6.5mm Hole Size - 18mm Flange Size 4.2x3.2mm Push Flange Black Nylon Push-Type Retainers		5
10367	7	10374
6.5mm Hole Size - 18mm Flange Size 4.2x3.2mm Push Flange Black Nylon Push-Type Retainers		8
10370	10	10372
6mm Hole Size - 18mm Flange Size 3.2x3.2mm Push Flange Black Nylon Push-Type Retainers		11
		10375
		6.5mm Hole Size - 18mm Flange Size 3.2x3.2mm Push Flange Black Nylon Push-Type Retainers
		10377
		10.5mm Hole Size - 25mm Flange Size 3.2x3.2mm Push Flange Black Nylon Push-Type Retainers
		10378
		10.5mm Hole Size - 25mm Flange Size 4.2x3.2mm Push Flange Black Nylon Push-Type Retainers
		12

FRONT OF TRAY

8637 (Plastic Tray)
Shipped In an Adjustable Gray Plastic Tray

8637YC (Plastic Tray)
Shipped In an Adjustable Yellow Plastic Tray

Covers 6.5mm to 10mm Hole Sizes
Black Nylon
Contains 11 Different Sizes
280 Total Pcs.
Ergo Tufloks Retainer Assortment
Sold Each



BACK OF TRAY					
# 8639 Toyota Nuts, Gromets & Retainer Assortment					
# 9591 1 6 Screw Size Head Diameter: 15mm Stem Length: 13mm, 7mm Square Hole Natural Nylon Screw Grommets	# 1614 2 10 Screw Size Fit 4 5/8mm Square Hole Natural Nylon	# 1560 3 10 Screw Size Head Size: 8mm x 10mm Natural Nylon Headlamp bezel & Grille Nuts	# 1576 4 10 Screw Size Head Diameter: 10mm Stem Length: 13mm Natural Nylon Screw Grommets	# 9912 5 # 12 Screw Size 10mm Square Hole Black Nylon Front & Rear Wheel Fender Liner Screw Grommets	# 1605 6 1/4" (8/16) Screw Size Head Diameter: 20mm Stem Length: 17mm Black Nylon Screw Grommets
	# 1466 8 7mm Hole Size Head Diameter: 15mm Stem Length: 15mm Black Nylon Retaining Clips	# 1996 9 7mm Hole Size Head Diameter: 15mm Stem Length: 15mm Black Nylon Retaining Clips	# 10141 10 7mm Hole Size Head Diameter: 20mm Stem Length: 15mm Black Nylon Head Insulation Retainers	# 9328 11 7mm Hole Size 17mm Stem Length 30mm Head Diameter Black Nylon Head Insulation Retainers	# 1950 12 7mm Hole Size Head Diameter: 20mm Stem Length: 17mm Black Nylon Retaining Clips
# 2145 13 7mm Hole Size Small Hd., 13mm, Large Hd., 18mm Stem Length: 15mm Natural Nylon Door Trim & Garnish Retainers	# 9081 14 7mm Hole Size Top Head Diameter: 18mm Stem Length: 18mm White Nylon Door Trim Panel Retainers	# 1503 15 7mm Hole Size Head Diameter: 15mm Stem Length: 12mm Black Nylon Push-Type Retainers	# 2027 16 8mm Hole Size Head Diameter: 15mm Stem Length: 12mm Black Nylon Bumper Cover Push-Type Retainer	# 9465 17 7mm Hole Size Hd Dia. 20mm, Stem Length: 8mm Black Nylon Front Fender Liner Push-Type Retainers	# 9327 18 8mm Hole Size Hd Dia. 18mm, Stem Lgth. 28mm Rear Bumper Cover Black Nylon Push-Type Retainers
# 9946 19 Stem Length: 13mm Head Diameter: 17mm Red Nylon Fender Moulding Clips	# 10113 20 Stem Length: 17mm Head Diameter: 17mm Blue Nylon Fender Moulding Clips	# 10112 21 Stem Length: 17mm, Head Diameter: 17mm Yellow Nylon Fender & Wheel Flare Moulding Clips		# 1606 23 # 14 (1/2") Screw Size Panel Range: Up to 17mm Center of Hole to Edge: 15mm Black Nylon Wheel Housing "U" Nuts	# 1601 24 10 Screw Size Panel Range: Up to 17mm Center of Hole to Edge: 11mm Black Nylon "U" Type Retainers
FRONT OF TRAY					

8539 (Metal Tray)
Shipped In a 24 Hole Gray Metal Tray

8639 (Plastic Tray)
Shipped In a 24 Hole Gray Plastic Tray

Covers Nuts, Grommets & Retainers
Toyota Cars
Contains 22 Different Sizes
430 Total Pcs.
Nut, Grommet & Retainer Assortment
Sold Each



BACK OF TRAY

8645

**Phillips Oval Head
Chrome Sheet Metal
Screw Assortment**

6399 1 3 x 1 3/8" #10 Head Sheet Metal Screws	6400 2 8 x 1 1/2" #10 Head Sheet Metal Screws	6401 3 8 x 3/4" #10 Head Sheet Metal Screws	6402 4 8 x 1" #10 Head Sheet Metal Screws	6403 5 8 x 1 1/4" #10 Head Sheet Metal Screws	6404 6 8 x 1 1/2" #10 Head Sheet Metal Screws	10163 7 8 x 1 3/8" #10 Head Sheet Metal Screws	10164 8 10 x 1 1/2" #10 Head Sheet Metal Screws
6405 9 10 x 3/4" #10 Head Sheet Metal Screws	6406 10 10 x 1" #10 Head Sheet Metal Screws	6407 11 10 x 1 1/4" #10 Head Sheet Metal Screws	6408 12 10 x 1 1/2" #10 Head Sheet Metal Screws	10165 13 10 x 1 3/4" #10 Head Sheet Metal Screws	6409 14 10 x 1 1/2" #10 Head Sheet Metal Screws	6410 15 10 x 3/4" #10 Head Sheet Metal Screws	6411 16 10 x 1" #10 Head Sheet Metal Screws
6412 17 10 x 1 1/4" #10 Head Sheet Metal Screws	6293 18 8 x 1 1/2" #10 Head Sheet Metal Screws	6294 19 8 x 3/4" #10 Head Sheet Metal Screws	6295 20 8 x 1" #10 Head Sheet Metal Screws	6295 21 8 x 1 1/4" #10 Head Sheet Metal Screws	6299 22 8 x 3/8" #10 Head Sheet Metal Screws	6300 23 8 x 1/2" #10 Head Sheet Metal Screws	6301 24 8 x 3/8" #10 Head Sheet Metal Screws
6302 25 8 x 1" #10 Head Sheet Metal Screws	6303 26 8 x 1 1/4" #10 Head Sheet Metal Screws	6304 27 8 x 1 1/2" #10 Head Sheet Metal Screws	6307 28 10 x 1 1/2" #10 Head Sheet Metal Screws	6309 29 10 x 3/4" #10 Head Sheet Metal Screws	6309 30 10 x 1" #10 Head Sheet Metal Screws	6310 31 10 x 1 1/4" #10 Head Sheet Metal Screws	6311 32 10 x 1 1/2" #10 Head Sheet Metal Screws

FRONT OF TRAY

8645 (Plastic Tray)

Shipped In a 32 Hole Gray Plastic Tray

Phillips Oval Head
Chrome Finish
Contains 32 Different Sizes
1510 Total Pcs.
Phillips Oval Head Sheet Metal Screw Assortment
Sold Each



BACK OF TRAY					
8647 Universal Nylon Rivet Assortment With Tool					
 1374 1 5/32" (4mm) Hole Size Rectangle Flange GR: 144 - 1532 Black Nylon Blind Rivets	 5768 2 3/16" (4.76mm) Hole Size Flange Size 11/32" GR: 532 - 114 Black Nylon Blind Rivets	 9053 3 15/64" (5.15mm) Hole Size Flange Size 15/32" GR: 116 - 1164 Black Nylon Blind Rivets	 10505 4 13/64" (5.15mm) Hole Size Flange Size 11/32" GR: 116 - 522 Black Nylon Blind Rivets	 5769 5 3/16" (5mm) Hole Size Flange Size 15/32" GR: 151 - 1564 Black Nylon Blind Rivets	 1204 21 Not Actual Size 6 1/2" Long Use for All Size Rivets (For Nylon Rivets Only) Single Stroke Rivet Setter Gun
 1195 6 3/16" (5mm) Hole Size Flange Size 15/32" GR: 1064 - 2084 Black Nylon Blind Rivets	 2080 7 15/64" (5.5mm) Hole Size Flange Size 1/2" GR: 1164 - 1132 Black Nylon Blind Rivets	 9854 8 15/64" (5.95mm) Hole Size Flange Size 5/8" GR: 522 - 516 Black Nylon Blind Rivets	 10503 9 1/4" (6.35mm) Hole Size Flange Size 21/32" GR: 132 - 1164 Black Nylon Blind Rivets	 10564 10 1/4" (6.35mm) Hole Size Flange Size 21/32" GR: 132 - 312 Black Nylon Blind Rivets	
 10562 11 1/4" (6.35mm) Hole Size Flange Size 21/32" GR: 522 - 114 Black Nylon Blind Rivets	 10560 12 1/4" (6.35mm) Hole Size Flange Size 1/2" GR: 522 - 932 Black Nylon Blind Rivets	 10551 13 1/4" (6.35mm) Hole Size Flange Size 11/16" GR: 522 - 318 Grey Nylon Blind Rivets	 1390 14 1/4" (6.35mm) Hole Size Flange Size 1/2" GR: 522 - 1532 Black Nylon Blind Rivets	 5770 15 1/4" (6.35mm) Hole Size Flange Size 43/64" GR: 522 - 1032 Black Nylon Blind Rivets	
 9128 16 1/4" (6.35mm) Hole Size Flange Size 43/64" GR: 518 - 1532 Black Nylon Blind Rivets	 9054 17 1/4" (6.35mm) Hole Size Flange Size 1/2" GR: 522 - 318 Black Nylon Blind Rivets	 5775 18 17/64" (6.6mm) Hole Size Flange Size 45/64" GR: 522 - 318 Black Nylon Blind Rivets	 1467 19 9/32" (7.14mm) Hole Size Flange Size 21/32" GR: 522 - 1564 Black Nylon Blind Rivets	 10630 20 1/4" (6.35mm) Hole Size Flange Size 21/32" GR: 522 - 318 Black Nylon Blind Rivets	
FRONT OF TRAY					

8647 (Plastic Tray) Shipped In a 21 Hole Gray Plastic Tray

Covers 4mm to 6.35mm Hole Sizes
 All Nylon With Tool
 Contains 20 Different Sizes
 260 Total Pcs.
 Nylon Pop Rivet Assortment
 Sold Each



BACK OF TRAY							
8649 Universal Nylon Rivet Assortment							
1374 1	5768 2	9053 3	10565 4	5769 5	1195 6	2080 7	9854 8
5/32" (4mm) Hole Size Rectangle Flange GR: 14" - 13/2" Black Nylon Blind Rivets	3/16" (4.75mm) Hole Size Flange Size 1 1/2" GR: 3/2" - 3/4" Black Nylon Blind Rivets	13/64" (5.15mm) Hole Size Flange Size 1 1/2" GR: 1 1/4" - 1 1/4" Black Nylon Blind Rivets	13/64" (5.15mm) Hole Size Flange Size 1 1/2" GR: 1 1/4" - 1 1/4" Black Nylon Blind Rivets	3/16" (5mm) Hole Size Flange Size 1 1/2" GR: 1 1/4" - 1 1/4" Black Nylon Blind Rivets	3/16" (5mm) Hole Size Flange Size 1 1/2" GR: 1 1/4" - 1 1/4" Black Nylon Blind Rivets	15/64" (5.95mm) Hole Size Flange Size 1 1/2" GR: 1 1/4" - 1 1/4" Black Nylon Blind Rivets	15/64" (5.95mm) Hole Size Flange Size 1 1/2" GR: 1 1/4" - 1 1/4" Black Nylon Blind Rivets
10563 9	10564 10	10562 11	10560 12	10561 13	1390 14	5770 15	9128 16
1/4" (6.35mm) Hole Size Flange Size 2 1/2" GR: 1 1/2" - 1 1/4" Black Nylon Blind Rivets	1/4" (6.35mm) Hole Size Flange Size 2 1/2" GR: 1 1/2" - 1 1/4" Black Nylon Blind Rivets	1/4" (6.35mm) Hole Size Flange Size 2 1/2" GR: 1 1/2" - 1 1/4" Black Nylon Blind Rivets	1/4" (6.35mm) Hole Size Flange Size 2 1/2" GR: 1 1/2" - 1 1/4" Black Nylon Blind Rivets	1/4" (6.35mm) Hole Size Flange Size 2 1/2" GR: 1 1/2" - 1 1/4" Black Nylon Blind Rivets	1/4" (6.35mm) Hole Size Flange Size 2 1/2" GR: 1 1/2" - 1 1/4" Black Nylon Blind Rivets	1/4" (6.35mm) Hole Size Flange Size 2 1/2" GR: 1 1/2" - 1 1/4" Black Nylon Blind Rivets	1/4" (6.35mm) Hole Size Flange Size 2 1/2" GR: 1 1/2" - 1 1/4" Black Nylon Blind Rivets
10561 13	1390 14	5770 15	9128 16	9054 17	5775 18	1467 19	10630 20
1/4" (6.35mm) Hole Size Flange Size 2 1/2" GR: 1 1/2" - 1 1/4" Gray Nylon Blind Rivets	1/4" (6.35mm) Hole Size Flange Size 2 1/2" GR: 1 1/2" - 1 1/4" Black Nylon Blind Rivets	1/4" (6.35mm) Hole Size Flange Size 2 1/2" GR: 1 1/2" - 1 1/4" Black Nylon Blind Rivets	1/4" (6.35mm) Hole Size Flange Size 2 1/2" GR: 1 1/2" - 1 1/4" Black Nylon Blind Rivets	1/4" (6.35mm) Hole Size Flange Size 2 1/2" GR: 1 1/2" - 1 1/4" Black Nylon Blind Rivets	17/64" (6.6mm) Hole Size Flange Size 4 5/8" GR: 3/2" - 3/16" Black Nylon Blind Rivets	3/32" (7.14mm) Hole Size Flange Size 2 1/2" GR: 3/2" - 1 1/4" Black Nylon Blind Rivets	1/4" (6.35mm) Hole Size Flange Size 2 1/2" GR: 1 1/2" - 1 1/4" Black Nylon Blind Rivets
FRONT OF TRAY							

8649 (Plastic Tray) Shipped In an Adjustable Gray Plastic Tray

- Covers 4mm to 6.35mm Hole Sizes
- All Nylon
- Contains 20 Different Sizes
- 355 Total Pcs.
- Nylon Pop Rivet Assortment
- Sold Each



BACK OF TRAY

8651
Universal
All Aluminum Rivet
Assortment With Tool

10585 1 3/32" (2.38mm) Hole Size Flange Size 5/16" GR: Fo - 1/4" All Aluminum	1888 2 1/8" (3.175mm) Hole Size Flange Size 1/4" GR: Fo - 1/8" All Aluminum	1889 3 1/8" (3.175mm) Hole Size Flange Size 1/4" GR: 3/16" - 1/4" All Aluminum	1890 4 1/8" (3.175mm) Hole Size Flange Size 1/4" GR: 5/16" - 3/8" All Aluminum	1891 5 1/8" (3.175mm) Hole Size Flange Size 1/4" GR: 3/8" - 1/2" All Aluminum	 1146 21 15" Overall Length Hex Nuts pieces for 5/32 1/8 5/32 & 3/16" Dia. Rivets Hand Riveter Not Actual Size
10592 6 5/32" (3.96mm) Hole Size Flange Size 5/16" GR: 1/8" - 1/4" All Aluminum	10593 7 5/32" (3.96mm) Hole Size Flange Size 5/16" GR: 1/8" - 3/16" All Aluminum	9572 8 5/32" (3.96mm) Hole Size Flange Size 5/16" GR: 3/16" - 1/4" All Aluminum	1899 9 3/16" (4.763mm) Hole Size Flange Size 3/8" GR: 1/4" - 1/8" All Aluminum	1900 10 3/16" (4.763mm) Hole Size Flange Size 3/8" GR: 1/8" - 1/4" All Aluminum	
1901 11 3/16" (4.763mm) Hole Size Flange Size 3/8" GR: 1/4" - 3/8" All Aluminum	1902 12 3/16" (4.763mm) Hole Size Flange Size 3/8" GR: 3/8" - 1/2" All Aluminum	10597 13 3/16" (4.763mm) Hole Size Flange Size 3/8" GR: 1/2" - 5/8" All Aluminum	10588 14 1/8" (3.175mm) Hole Size Flange Size 3/8" GR: 1/4" - 1/8" All Aluminum	9596 15 1/8" (3.175mm) Hole Size Flange Size 3/8" GR: 3/16" - 1/4" All Aluminum	
10124 16 1/8" (3.175mm) Hole Size Flange Size 3/8" GR: 5/16" - 3/8" All Aluminum	10594 17 5/32" (3.96mm) Hole Size Flange Size 1/2" GR: 3/16" - 1/4" All Aluminum	1903 18 3/16" (4.763mm) Hole Size Flange Size 5/8" GR: 1/8" - 1/4" All Aluminum	1904 19 3/16" (4.763mm) Hole Size Flange Size 5/8" GR: 1/4" - 3/8" All Aluminum	1905 20 3/16" (4.763mm) Hole Size Flange Size 5/8" GR: 3/8" - 1/2" All Aluminum	

FRONT OF TRAY

8651 (Plastic Tray)

Shipped In a 21 Hole Gray Plastic Tray

Covers 3/32" to 3/16" Hole Sizes
All Aluminum With Tool
Contains 20 Different Sizes
636 Total Pcs.
All Aluminum Pop Rivet Assortment
Sold Each



BACK OF TRAY

8653 Universal All Aluminum Rivet Assortment							
<p>0243 1</p> <p>1/8" (3.175mm) Hole Size Flange Size 1/4" GR: 3/16" - 1/4" Black Finish All Aluminum</p>	<p>1799 2</p> <p>1/8" (3.175mm) Hole Size Flange Size 3/8" GR: 1/8" - 3/16" Black Finish Alum. Steel</p>	<p>10595 3</p> <p>3/32" (2.381mm) Hole Size Flange Size 3/16" GR: 1/8" - 1/4" All Aluminum</p>	<p>10586 4</p> <p>3/32" (2.381mm) Hole Size Flange Size 3/16" GR: 1/8" - 1/4" All Aluminum</p>	<p>10587 5</p> <p>1/8" (3.175mm) Hole Size Flange Size 1/4" GR: 1/32" - 5/16" All Aluminum</p>	<p>1888 6</p> <p>1/8" (3.175mm) Hole Size Flange Size 1/4" GR: 1/16" - 1/4" All Aluminum</p>	<p>10589 7</p> <p>1/8" (3.175mm) Hole Size Flange Size 1/4" GR: 1/8" - 3/16" All Aluminum</p>	<p>1889 8</p> <p>1/8" (3.175mm) Hole Size Flange Size 1/4" GR: 3/16" - 1/4" All Aluminum</p>
<p>10590 9</p> <p>1/8" (3.175mm) Hole Size Flange Size 1/4" GR: 5/4" - 5/16" All Aluminum</p>	<p>1890 10</p> <p>1/8" (3.175mm) Hole Size Flange Size 1/4" GR: 5/16" - 3/8" All Aluminum</p>	<p>1891 11</p> <p>1/8" (3.175mm) Hole Size Flange Size 1/4" GR: 3/8" - 1/2" All Aluminum</p>	<p>10592 12</p> <p>5/32" (3.96mm) Hole Size Flange Size 3/16" GR: 1/8" - 1/8" All Aluminum</p>	<p>10593 13</p> <p>5/32" (3.96mm) Hole Size Flange Size 3/16" GR: 1/8" - 3/16" All Aluminum</p>	<p>9572 14</p> <p>5/32" (3.96mm) Hole Size Flange Size 3/16" GR: 3/16" - 1/4" All Aluminum</p>	<p>10595 15</p> <p>5/32" (3.96mm) Hole Size Flange Size 3/16" GR: 1/4" - 3/8" All Aluminum</p>	<p>10596 16</p> <p>5/32" (3.96mm) Hole Size Flange Size 3/16" GR: 3/8" - 1/2" All Aluminum</p>
<p>1899 17</p> <p>3/16" (4.763mm) Hole Size Flange Size 3/8" GR: 1/8" - 1/8" All Aluminum</p>	<p>1900 18</p> <p>3/16" (4.763mm) Hole Size Flange Size 3/8" GR: 1/4" - 1/4" All Aluminum</p>	<p>1901 19</p> <p>3/16" (4.763mm) Hole Size Flange Size 3/8" GR: 1/4" - 3/8" All Aluminum</p>	<p>1902 20</p> <p>3/16" (4.763mm) Hole Size Flange Size 3/8" GR: 3/8" - 1/2" All Aluminum</p>	<p>10597 21</p> <p>3/16" (4.763mm) Hole Size Flange Size 3/8" GR: 1/2" - 5/8" All Aluminum</p>	<p>10599 22</p> <p>3/16" (4.763mm) Hole Size Flange Size 3/8" GR: 5/8" - 3/4" All Aluminum</p>	<p>10588 23</p> <p>1/8" (3.175mm) Hole Size Flange Size 3/8" GR: 1/16" - 1/8" All Aluminum</p>	<p>9596 24</p> <p>1/8" (3.175mm) Hole Size Flange Size 3/8" GR: 3/16" - 1/4" All Aluminum</p>
<p>10124 25</p> <p>1/8" (3.175mm) Hole Size Flange Size 3/8" GR: 3/16" - 3/8" All Aluminum</p>	<p>10594 26</p> <p>5/32" (3.96mm) Hole Size Flange Size 3/8" GR: 3/16" - 1/4" All Aluminum</p>	<p>1903 27</p> <p>3/16" (4.763mm) Hole Size Flange Size 3/8" GR: 1/8" - 1/4" All Aluminum</p>	<p>1904 28</p> <p>3/16" (4.763mm) Hole Size Flange Size 3/8" GR: 1/4" - 3/8" All Aluminum</p>	<p>1905 29</p> <p>3/16" (4.763mm) Hole Size Flange Size 3/8" GR: 3/8" - 1/2" All Aluminum</p>	<p>10598 30</p> <p>3/16" (4.763mm) Hole Size Flange Size 3/8" GR: 1/2" - 5/8" All Aluminum</p>		

FRONT OF TRAY

8653 (Plastic Tray)

Shipped In an Adjustable Gray Plastic Tray

Covers 3/32" to 3/16" Hole Sizes

All Aluminum

Contains 30 Different Sizes

885 Total Pcs.

All Aluminum Pop Rivet Assortment

Sold Each



BACK OF TRAY

8655
Universal
Automotive Rivet
Assortment



















5454 1 1/8" (mm) Hole Size Flange Size G/R: 3/16" - 1/4" Black Finish All Aluminum 通用汽車用螺絲釘	9893 2 1/8" (mm) Hole Size Flange Size 3/16" G/R: 1/8" - 3/16" Stainless Steel/Steel 通用汽車用螺絲釘	9118 3 1/8" (mm) Hole Size Flange Size 3/8" G/R: 1/16" - 1/8" Black Finish Alum./Steel 通用汽車用螺絲釘	9243 4 1/8" (mm) Hole Size Flange Size 1/2" G/R: 3/16" - 1/4" All Alum. Black Finish 通用汽車用螺絲釘	1799 5 1/8" (mm) Hole Size Flange Size 5/8" G/R: 1/8" - 3/16" Black Finish Alum./Steel 通用汽車用螺絲釘	9277 6 5/32" (mm) Hole Size Flange Size 15/32" G/R: 1/8" - 1/4" Black Finish Alum./Steel 通用汽車用螺絲釘	9718 7 3/16" (5mm) Hole Size Flange Size 3/8" G/R: 1/16" - 1/8" All Steel Black Finish 通用汽車用螺絲釘	9453 8 3/16" (5mm) Hole Size Flange Size 3/4" G/R: 3/8" - 1/2" All Alum. Black Finish 通用汽車用螺絲釘
9278 9 3/16" (mm) Hole Size Flange Size 3/8" G/R: 5/64" - 1/32" Black Alum. Split-Type Rivets 通用汽車用螺絲釘	4005 10 3/16" (5mm) Hole Size Flange Size 1/2" G/R: 3/32" - 1/2" All Alum. Black Finish 通用汽車用螺絲釘	1609 11 3/16" (5mm) Hole Size Flange Size 7/16" G/R: 5/64" - 15/64" All Alum. Black Finish 通用汽車用螺絲釘	9618 12 3/16" (5mm) Hole Size Flange Size 3/4" G/R: 11/16" - 13/16" All Aluminum 通用汽車用螺絲釘	9885 13 1/4" (6.35mm) Hole Size Flange Size 1/2" G/R: 1/8" - 1/4" Grey Nylon Blind Rivets 通用汽車用螺絲釘	4009 14 1/4" (6.35mm) Hole Size Flange Size 1/2" G/R: 3/32" - 1/2" Aluminum/Steel 通用汽車用螺絲釘	4007 15 1/4" (6.35mm) Hole Size Flange Size 7/16" G/R: 1/2" - 3/64" Aluminum/Steel 通用汽車用螺絲釘	9902 16 1/4" (6.35mm) Hole Size Flange Size 3/4" G/R: 9/64" - 3/16" Aluminum/Steel 通用汽車用螺絲釘
9644 17 1/4" (6.35mm) Hole Size Flange Size 19/32" (Includes 19/32" G/R: 3/64" - 5/64" All Steel Bright Zinc Finish 通用汽車用螺絲釘	4002 18 1/4" (6.35mm) Hole Size Flange Size 3/4" G/R: 1/8" - 1/4" All Steel Black Finish 通用汽車用螺絲釘	4008 19 1/4" (6.35mm) Hole Size Flange Size 1/2" G/R: 3/16" - 19/32" Aluminum/Steel 通用汽車用螺絲釘	1951 20 1/4" (6.35mm) Hole Size Flange Size 1 1/8" G/R: 3/16" - 3/8" Aluminum/Steel Black Finish 通用汽車用螺絲釘	FRONT OF TRAY			

8655 (Plastic Tray)

Shipped In an Adjustable Gray Plastic Tray

Covers 1/8" to 1/4" Hole Sizes
 Aluminum Steel Rivets
 Contains 20 Different Sizes
 375 Total Pcs.
 Automotive Pop Rivet Assortment
 Sold Each



BACK OF TRAY							
8657 Blade Type Fuse Assortment							
 1734 1	 1735 2	 1736 3	 1737 4	 1738 5	 1739 6	 1740 7	8
 1709 9	 1710 10	 1711 11	 1712 12				
 1713 13	 1714 14	 1715 15	 1785 16				
 1786 17	 1787 18	 1788 19	 1789 20				
FRONT OF TRAY							

8657 (Plastic Tray) Shipped In an Adjustable Gray Plastic Tray

Covers 5 AMP to 60 AMP
Blade Type
Contains 19 Different Sizes
305 Total Pcs.
Blade Fuse Assortment
Sold Each



BACK OF TRAY

8659
Universal
Hood Insulation Retainers
& Hood Seal Clips
Assortment

9262 1 6mm Hole Size Head Diameter: 12mm Black Nylon Honda Hood & Trunk Moulding Clips	9520 2 5/16" (8mm) Hole Size Head Diameter: 5/8" Black Nylon G.M. Hood Seal Retainers	9522 3 6mm Hole Size Head Diameter: 14mm Black Nylon Ford Hood Insulation Ret.	10462 4 7mm Hole Size Head Diameter: 12.5mm Black Nylon G.M. Hood Insulation Ret.	10613 5 4.75mm Hole Size Head Diameter: 19mm Black Nylon Ford Hood Insulation Ret.	1930 6 1 1/4" (6.4mm) Hole Size Head Diameter: 1 3/16" (4.8mm) Black Nylon G.M. Hood Insulation Ret.
10141 7 7mm Hole Size Head Diameter: 23mm Black Nylon Toyota Hood Insulation Ret.	10391 8 6.2mm Hole Size Head Diameter: 23.4mm Black Nylon Chrysler Hood Insulation Ret.	2025 9 5.3mm Hole Size Head Diameter: 29.4mm Black Nylon Nissan Hood Insulation Ret.	9980 10 6.3mm Hole Size Head Diameter: 38mm Black Nylon Chrysler Hood Insulation Ret.	10379 11 6mm Hole Size Head Diameter: 30mm Black Nylon Honda Hood Insulation Ret.	5440 12 1 1/4" (6.4mm) Hole Size Head Diameter: 2" (50.8mm) Black Polypropylene G.M. Hood Insulation Ret.
969 13 6mm Hole Size Head Diameter: 37.5mm Black Nylon Ford Hood Insulation Ret.	2167 14 6.3mm Hole Size Head Diameter: 38mm Black Nylon G.M. Hood Insulation Ret.	1950 15 7mm Hole Size Head Diameter: 30mm Black Nylon Toyota Hood Insulation Ret.	9588 16 6mm Hole Size Head Diameter: 30mm Black Nylon Ford Hood Insulation Ret.	9328 17 7mm Hole Size Head Diameter: 30mm Black Nylon Toyota Hood Insulation Ret.	5440 18 1 1/4" (6.4mm) Hole Size Head Diameter: 2" (50.8mm) Black Polypropylene G.M. Hood Insulation Ret.
9945 19 7.5mm Hole Diameter Head Diameter: 28mm Black Nylon Acura Hood Insulation Ret.	2111 20 6.3mm Hole Size Head Diameter: 32mm Black Nylon Ford Hood Insulation Ret.	1929 21 6.3mm Hole Size Head Diameter: 1 3/8" (35mm) Black Polypropylene G.M. Hood Insulation Ret.	10393 22 7.5mm Hole Size Head Diameter: 48mm Black Nylon G.M. Hood Insulation Ret.	9513 23 6.4mm Hole Size Head Diameter: 1 2/8" (44.5mm) Black Nylon Ford Hood Insulation Ret.	1573 24 7.5mm Hole Size Head Diameter: 44.7mm Black Nylon Ford Hood Insulation Ret.

FRONT OF TRAY

8559 (Metal Tray)
Shipped In a 24 Hole Gray Metal Tray

8659 (Plastic Tray)
Shipped In a 24 Hole Gray Plastic Tray

Covers 6mm to 7.5mm Hole Sizes

Black Nylon

Contains 24 Different Sizes

331 Total Pcs.

Hood Seal & Insulation Ret. Assortment

Sold Each



BACK OF TRAY							
# 8661 License Plate Screw & Nut Assortment							
<p>9838 6 - 1.00mm 10mm Hex Size Black Nylon License Plate Hex Nuts</p>	<p>9839 6 - 1.00 x 16mm Slotted Pan Head Black Nylon License Plate Screws</p>	<p>9840 6 - 1.00 x 20mm Slotted Pan Head Black Nylon License Plate Screws</p>	<p>10095 6 - 1.00 x 20mm Phillips Pan Head Black Nylon License Plate Screws</p>	<p>1228 1/4" (#14) Screw Size White Plastic License Plate Nuts</p>	<p>2123 1/4" (#14) x 3/4" 13mm Indented Hex 12mm O.D. Washer Head Phillips Yellow Zinc Finish License Plate Screws</p>	<p>1620 1/4" x 3/4" 3/8" Indented Hex Size 1/2" O.D. Washer Head Slotted Bright Zinc Finish License Plate Screws</p>	<p>9934 1/4" (#14) x 3/4" 3/8" Indented Hex 1/2" O.D. Washer Head Slotted Black Finish License Plate Screws</p>
<p>9494 1/4" (#14) Screw Size Natural Nylon License Plate Nuts</p>	<p>2121 1/4" (#14) x 3/4" 9/16" Head Diameter Phillips Truss Head Zinc Plated License Plate Screws</p>	<p>477 1/4" (#14) x 3/4" 9/16" Head Diameter Slotted Truss Head Zinc Plated License Plate Screws</p>	<p>2062 1/4" (#14) x 3/4" 9/16" Head Diameter Slotted Truss Head Black Finish License Plate Screws</p>	<p>2136 6 - 1.00 x 12mm Phillips Pan Head Bright Zinc Finish Machine Screws</p>	<p>1851 6 - 1.00 x 16mm Phillips Pan Head Bright Zinc Finish Machine Screws</p>	<p>9168 6 - 1.00 x 20mm Phillips Pan Head Bright Zinc Finish Machine Screws</p>	<p>2124 6 - 1.00 x 16mm 12mm Hex Size Slotted Hex Washer Head Bright Zinc Finish License Plate Screws</p>
<p>10455 6.5-7.81 X 16mm Dax-Drive Truss Head Silver Dacromet Finish License Plate Screws</p>	<p>1939 1/4" (#14) x 5/8" 5/8" O.D. Washer 5/16" Indented Hex Head Slotted Black Finish License Plate Screws</p>	<p>10514 1/4-20 x 3/4" 5/16" Head Diameter Slotted Truss Head Zinc Plated License Plate Screws</p>	<p>9882 1/4-20 x 5/8" Truss Slot Washer Head 15/32" O.D. Washer Black Nylon License Plate Screws</p>				
FRONT OF TRAY							

8661 (Plastic Tray)

Shipped In an Adjustable Gray Plastic Tray

Covers 1/4" and 6mm
Nylon & Metal Nuts & Screws
Contains 20 Different Sizes
520 Total Pcs.
License Plate Nut & Screw Assort
Sold Each



BACK OF TRAY					
# 8663					
Universal Hyundai Retainer Assortment					
# 10767 1 	# 10766 2 	# 10773 3 	# 10774 4 	# 10744 5 	# 10785 6
# 10780 7 	# 10770 8 	# 10784 9 	# 10769 10 	# 10555 11 	# 9287 12
# 10772 13 	# 10783 14 	# 10779 15 	# 10771 16 	# 10781 17 	# 10782 18
# 10775 19 	# 10776 20 	# 10777 21 	# 10796 22 	# 10778 23 	# 10778 24
FRONT OF TRAY					

8563 (Metal Tray)
Shipped In a 24 Hole Gray Metal Tray

8663 (Plastic Tray)
Shipped In a 24 Hole Gray Plastic Tray

Covers Door Panel & Grommets
Nylon & Metal Retainers
Contains 23 Different Sizes
405 Total Pcs.
Hyundai Retainer Assortment
Sold Each



BACK OF TRAY		
# 8667 Zinc Finish Cage Nut Assortment		
# 11005 Size: 10-24 Panel Range: .25-.063 Mounting Hole: 3/8	1	# 11006 Size: 10-24 Panel Range: .094-.105 Mounting Hole: 3/8
# 11007 Size: 10-32 Panel Range: .225-.063 Mounting Hole: 3/8	2	# 11008 Size: 10-32 Panel Range: .064-.105 Mounting Hole: 3/8
# 11009 Size: 1/4-20 Panel Range: .025-.063 Mounting Hole: 3/8	3	# 11010 Size: 1/4-20 Panel Range: .064-.105 Mounting Hole: 3/8
# 11011 Size: 5/16-18 Panel Range: .093-.126 Mounting Hole: 1/2	4	# 11012 Size: 3/8-16 Panel Range: .093-.126 Mounting Hole: 1/2
# 11013 Size: M5 x 6.8 Panel Range: 1.628-2.667 Mounting Hole: 3/8	5	# 11014 Size: M6 x 1 Panel Range: .635-1.60 Mounting Hole: 3/8
# 11015 Size: M6 x 1 Panel Range: 1.628-2.667 Mounting Hole: 3/8	6	# 11016 Size: 3/8-24 Panel Range: .257-.032 Mounting Hole: 1/2 Black Finish
FRONT OF TRAY		

8667 (Plastic Tray)

Shipped In an Adjustable Gray Plastic Tray

Covers 10-24 to 3/8", 5mm & 6mm
 Bright Zinc Finish
 Contains 12 Different Sizes
 505 Total Pcs.
 Cage Nut Assortment
 Sold Each



HOSE CLAMPS



10889 #4 Mini CR 14 - 3/8 Hose ID 1/8-5/8	10890 #6 Mini CR 5/16 - 7/8 Hose ID 1/4-2 1/8	10891 #6 Clamp CR 3/8 - 7/8 Hose ID 3/16-3/8	10893 #10 Clamp CR 1/2 - 1 1/16 Hose ID 3/8-5/8	10894 #12 Clamp CR 1/2 - 1 1/4 Hose ID 3/8-3/4	10895 #16 Clamp CR 1/2 - 1 1/2 Hose ID 3/4-7/8	10896 #20 Clamp CR 3/4 - 1 3/4 Hose ID 3/4 - 1 1/8	10898 #28 Clamp CR 1 1/4 - 2 1/2 Hose ID 1 1/4-1 5/8	10899 #32 Clamp CR 1 1/2 - 2 1/2 Hose ID 1 1/2 - 1 7/8	10900 #36 Clamp CR 1 3/4 - 2 3/4 Hose ID 1 3/4 - 2
---	---	--	---	--	--	--	--	--	--

HOSE CLAMPS



10889 #4 Mini CR 14 - 3/8 Hose ID 1/8-5/8	10890 #6 Mini CR 5/16 - 7/8 Hose ID 1/4-2 1/8	10891 #6 Clamp CR 3/8 - 7/8 Hose ID 3/16-3/8	10893 #10 Clamp CR 1/2 - 1 1/16 Hose ID 3/8-5/8	10894 #12 Clamp CR 1/2 - 1 1/4 Hose ID 3/8-3/4	10895 #16 Clamp CR 1/2 - 1 1/2 Hose ID 3/4-7/8	10896 #20 Clamp CR 3/4 - 1 3/4 Hose ID 3/4 - 1 1/8	10898 #28 Clamp CR 1 1/4 - 2 1/2 Hose ID 1 1/4-1 5/8	10899 #32 Clamp CR 1 1/2 - 2 1/2 Hose ID 1 1/2 - 1 7/8	10900 #36 Clamp CR 1 3/4 - 2 3/4 Hose ID 1 3/4 - 2
---	---	--	---	--	--	--	--	--	--

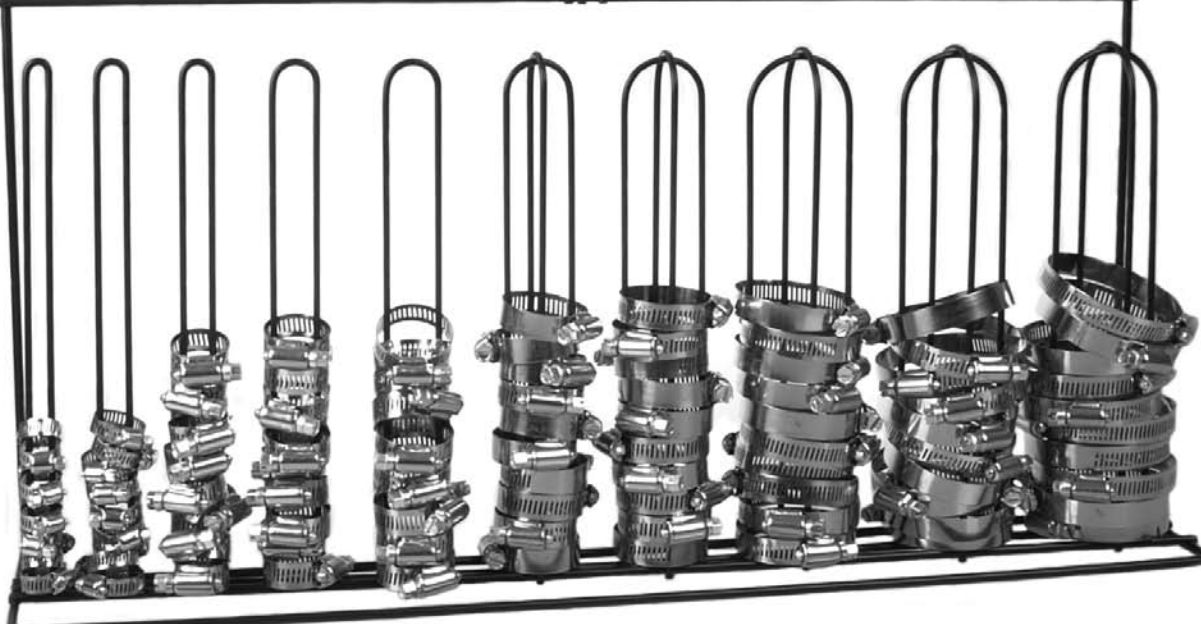

8701

Stainless Steel Band and Housing
#4 to #36 Clamp Sizes
Contains 10 Different Sizes
100 Total Pcs.
Hose Clamp Assortment
Sold Each

Popular Body Shop Fasteners

Disco Automotive Hardware
Distributed by:

English Wall Poster

1 EP
 26" x 39" English Wall Poster
 Covers Top Selling Body Shop Fasteners
 Contains 209 Different Items
 Sold Each

Metropolitan Supply carries many more items than what is found in this catalog. See our website for the entire lineup of what we offer.



7580 Quattro Drive, Chanhassen, MN 55317
1-800-844-3008 Toll Free | 1-888-244-7329 Toll Free Fax
www.MetropolitanSupply.com



Auto Hdwe